

CMS632-W480E/Q470E

10th Gen Intel® Core™
Desktop
ATX

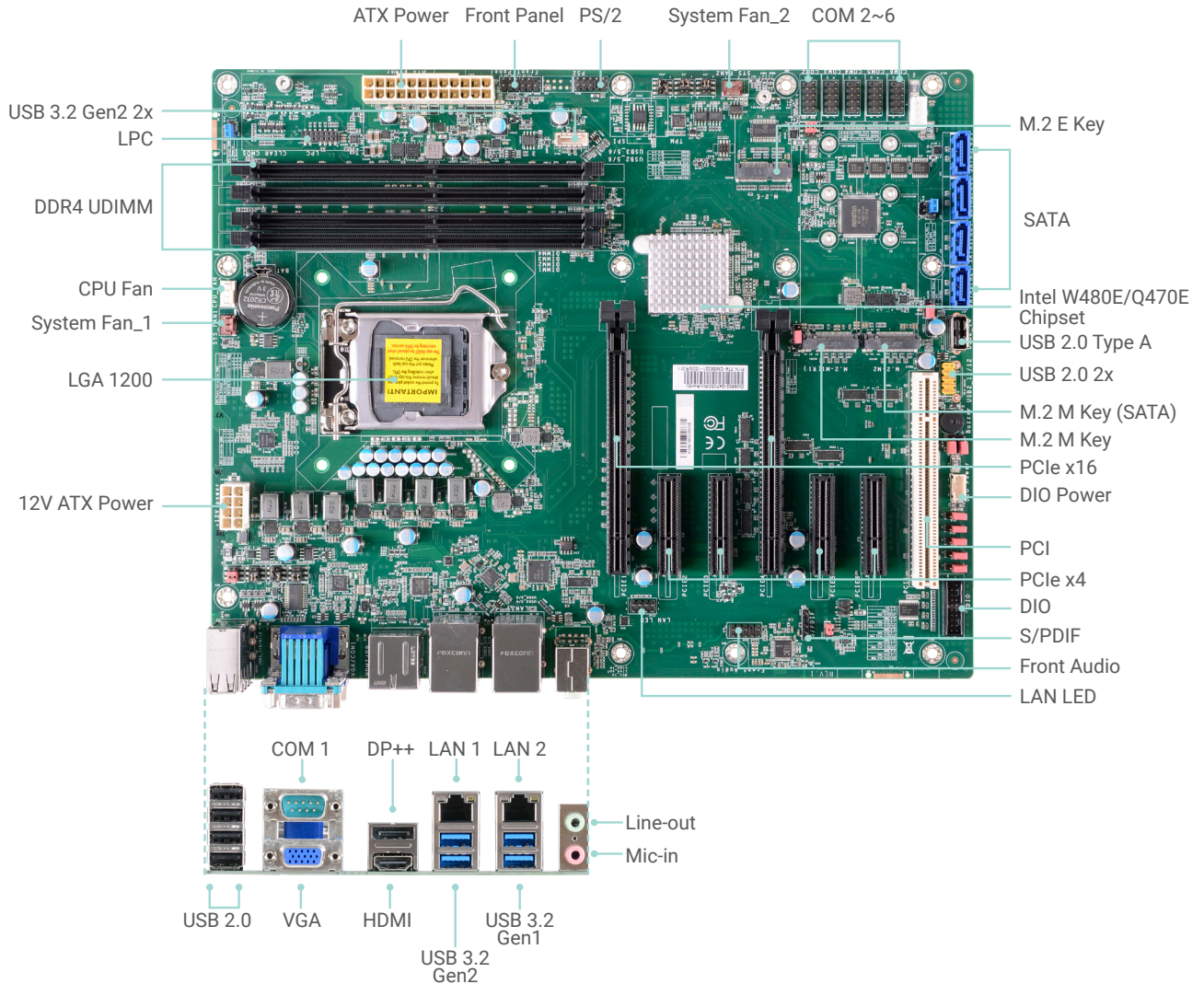

Top View

KEY FEATURES



DDR4

4 DDR4 UDIMM up to 128GB



4K High Resolution

Supports 4K/ 2K resolution



Triple Displays

VGA + DP++ + HDMI

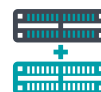

Multiple Expansion

2 PCIe x16(1 x16 signal or 2 x8 signal), 4 PCIe x4, 1 PCI, 2 M.2 M Key, 1 M.2 E Key



Rich I/O

2 Intel GbE, 4 USB 3.2 Gen2, 2 USB 3.2 Gen1, 7 USB 2.0

BLOCK DIAGRAM

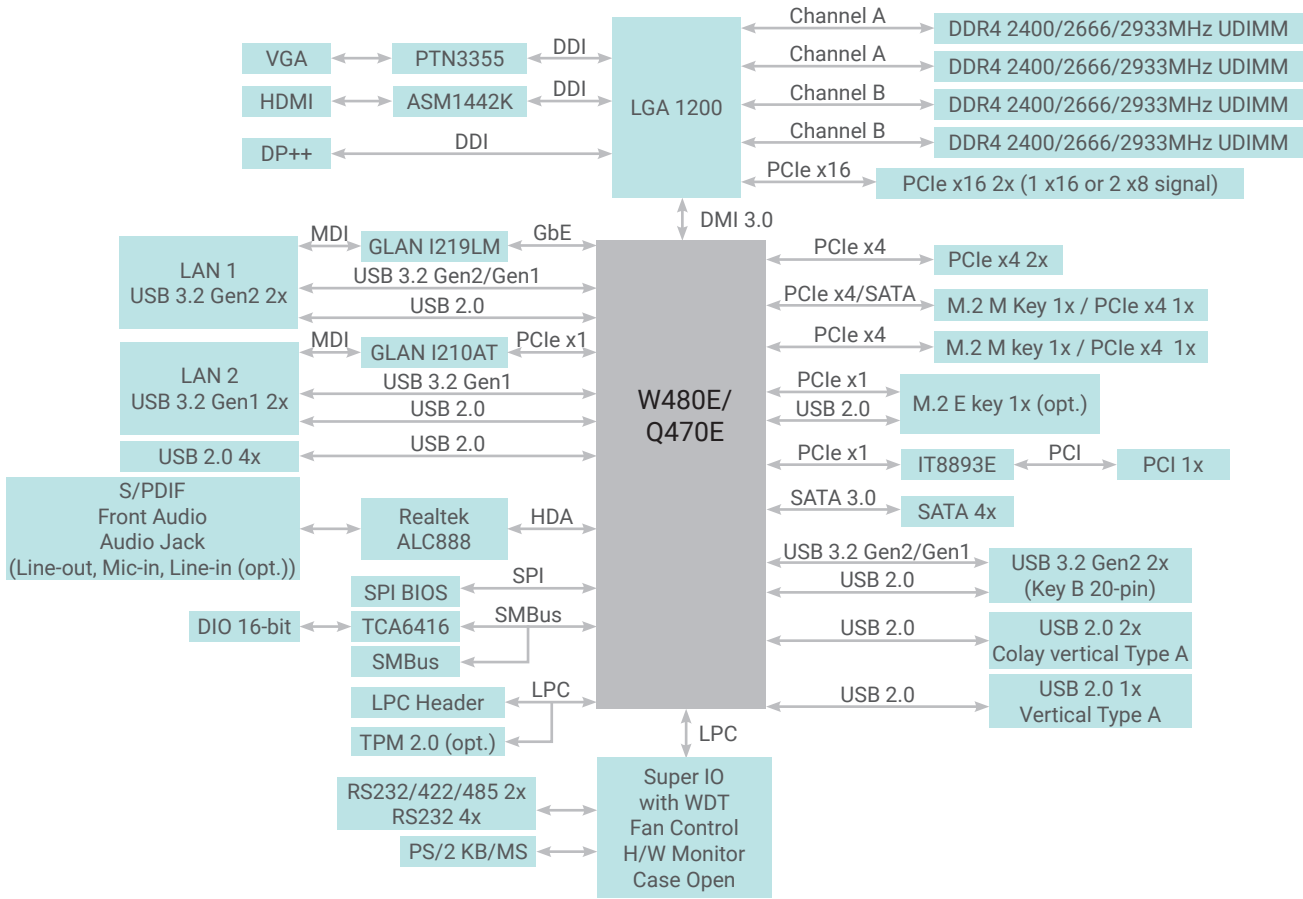

MECHANICAL DRAWING

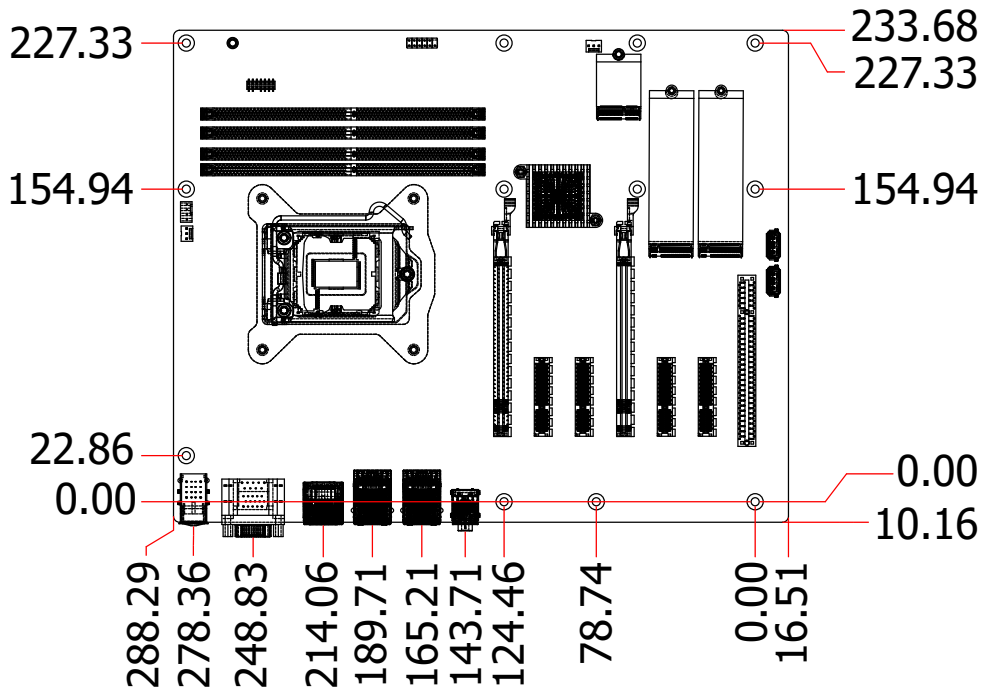

SPECIFICATION

Model Name		CMS632-W480E	CMS632-Q470E
SYSTEM	Processor	10th Generation Intel® LGA 1200 Socket Processors, TDP support up to 125W Intel® Xeon® W-1290E (10 Cores, 20M Cache, up to 4.8 GHz); 95W (ECC support on W480E SKU only) Intel® Xeon® W-1290TE (10 Cores, 20M Cache, up to 4.5 GHz); 35W (ECC support on W480E SKU only) Intel® Xeon® W-1270E (8 Cores, 16M Cache, up to 4.8 GHz); 80W (ECC support on W480E SKU only) Intel® Xeon® W-1270TE (8 Cores, 16M Cache, up to 4.4 GHz); 35W (ECC support on W480E SKU only) Intel® Xeon® W-1250E (6 Cores, 12M Cache, up to 4.7 GHz); 80W (ECC support on W480E SKU only) Intel® Xeon® W-1250TE (6 Cores, 12M Cache, up to 3.8 GHz); 35W (ECC support on W480E SKU only) Intel® Core™ i9-10900E (10 Cores, 20M Cache, up to 4.7 GHz); 65W Intel® Core™ i9-10900TE (10 Cores, 20M Cache, up to 4.5 GHz); 35W Intel® Core™ i7-10700E (8 Cores, 16M Cache, up to 4.5 GHz); 65W Intel® Core™ i7-10700TE (8 Cores, 16M Cache, up to 4.4 GHz); 35W Intel® Core™ i5-10500E (6 Cores, 12M Cache, up to 4.2 GHz); 65W Intel® Core™ i5-10500TE (6 Cores, 12M Cache, up to 3.7 GHz); 35W Intel® Core™ i3-10100E (4 Cores, 6M Cache, 3.8 GHz); 65W (ECC support on W480E SKU only) Intel® Core™ i3-10100TE (4 Cores, 6M Cache, to 3.6 GHz); 35W (ECC support on W480E SKU only) Intel® Pentium® G6400E (2 Cores, 4M Cache, 3.8 GHz); 58W (Not support on W480E SKU) Intel® Celeron® G5900E (2 Cores, 2M Cache, 3.2 GHz); 58W (Not support on W480E SKU) Intel® Celeron® G5900TE (2 Cores, 2M Cache, 3.0 GHz); 35W (Not support on W480E SKU)	
	Chipset	Intel® W480E Chipset	Intel® Q470E Chipset
	Memory	Four 288-pin Non-ECC UDIMM up to 128GB (Core™ i5/i7 only support non-ECC) Dual Channel DDR4 2400/2666/2933MHz (ECC/Non-ECC)	Four 288-pin Non-ECC UDIMM up to 128GB (Core™ i5/i7 only support non-ECC) Dual Channel DDR4 2400/2666/2933MHz (Non-ECC)
	BIOS	AMI SPI 128Mbit	AMI SPI 128Mbit
	GRAPHICS	Controller	Intel® HD Gen 9 Graphics
	Feature	OpenGL 4.5, DirectX 12, OpenCL 2.1 HW Decode: AVC/H.264, MPEG2, VC1/WMV9, JPEG/MJPEG, HEVC/H265, VP8, VP9 HW Encode: MPEG2, AVC/H264, JPEG, HEVC/H265, VP8, VP9	OpenGL 4.5, DirectX 12, OpenCL 2.1 HW Decode: AVC/H.264, MPEG2, VC1/WMV9, JPEG/MJPEG, HEVC/H265, VP8, VP9 HW Encode: MPEG2, AVC/H264, JPEG, HEVC/H265, VP8, VP9
	Display	1 x VGA 1 x DP++ 1 x HDMI 1.4b VGA: resolution up to 1920x1200 @ 60Hz DP++: resolution up to 4096x2160 @ 60Hz HDMI: resolution up to 4096x2160 @ 24Hz	1 x VGA 1 x DP++ 1 x HDMI 1.4b VGA: resolution up to 1920x1200 @ 60Hz DP++: resolution up to 4096x2160 @ 60Hz HDMI: resolution up to 4096x2160 @ 24Hz
	Triple Displays	VGA + DP++ + HDMI	VGA + DP++ + HDMI
EXPANSION	Interface	2 x PCIe x16 (Gen 3) (1 x16 signal or 2 x8 signal) 4 x PCIe x4 (Gen 3) (2 PCIe x4 co-lay M.2 M Key, function selected by jumper.) 1 x PCI	2 x PCIe x16 (Gen 3) (1 x16 signal or 2 x8 signal) 4 x PCIe x4 (Gen 3) (2 PCIe x4 co-lay M.2 M Key, function selected by jumper.) 1 x PCI
	M.2	1 x M.2 2242/2260/2280 M Key (PCIe Gen3 x4 NVMe/SATA/Intel® RST support) (co-lay PCIe x4 slot#5, function selected by jumper.)	1 x M.2 2242/2260/2280 M Key (PCIe Gen3 x4 NVMe/SATA/Intel® RST support) (co-lay PCIe x4 slot#5, function selected by jumper.)
		1 x M.2 2242/2260/2280 M Key (PCIe Gen3 x4 NVMe/Intel® RST support) (co-lay PCIe x4 slot#6, function selected by jumper.)	1 x M.2 2242/2260/2280 M Key (PCIe Gen3 x4 NVMe/Intel® RST support) (co-lay PCIe x4 slot#6, function selected by jumper.)
		1 x M.2 2230 E Key (USB 2.0/PCIe x1) (opt.)	1 x M.2 2230 E Key (USB 2.0/PCIe x1) (opt.)
AUDIO	Audio Codec	Realtek ALC888	Realtek ALC888
ETHERNET	Controller	1 x Intel® I210AT PCIe (10/100/1000Mbps) 1 x Intel® I219LM PHY with iAMT12.0 (10/100/1000Mbps) (only Xeon, Core i9/ i7/i5 supports iAMT)	1 x Intel® I210AT PCIe (10/100/1000Mbps) 1 x Intel® I219LM PHY with iAMT12.0 (10/100/1000Mbps) (only Xeon, Core i9/ i7/i5 supports iAMT)
REAR I/O	Ethernet	2 x GbE (RJ-45)	2 x GbE (RJ-45)
	Serial	1 x RS-232/422/485 (RS-232 w/ power) (DB-9)	1 x RS-232/422/485 (RS-232 w/ power) (DB-9)
	USB	2 x USB 3.2 Gen2 2 x USB 3.2 Gen1 4 x USB 2.0	2 x USB 3.2 Gen2 2 x USB 3.2 Gen1 4 x USB 2.0
	Display	1 x VGA 1 x DP++ 1 x HDMI	1 x VGA 1 x DP++ 1 x HDMI
	Audio	1 x Line-out, 1 x Mic-in, 1 x Line-in (opt., MOQ required)	1 x Line-out, 1 x Mic-in, 1 x Line-in (opt., MOQ required)
INTERNAL I/O	Serial	1 x RS-232/422/485 (RS-232 w/ power) (2.54mm pitch) 4 x RS-232 (2.54mm pitch)	1 x RS-232/422/485 (RS-232 w/ power) (2.54mm pitch) 4 x RS-232 (2.54mm pitch)
	USB	2 x USB 3.2 Gen 2 (Key B 20-pin) 2 x USB 2.0 (2.54mm pitch, Colay vertical Type A, opt.: MOQ required) 1 x USB 2.0 Vertical Type A	2 x USB 3.2 Gen 2 (Key B 20-pin) 2 x USB 2.0 (2.54mm pitch, Colay vertical Type A, opt.: MOQ required) 1 x USB 2.0 Vertical Type A

SPECIFICATION

Model Name		CMS632-W480E	CMS632-Q470E
INTERNAL I/O	Audio	1 x Front Audio Header 1 x S/PDIF	1 x Front Audio Header 1 x S/PDIF
	SATA	4 x SATA 3.0 (up to 6Gb/s, SATA 3) RAID 0/1/5/10	4 x SATA 3.0 (up to 6Gb/s, SATA 3) RAID 0/1/5/10
	PS/2	1 x PS/2 (mini-DIN-6)	1 x PS/2 (mini-DIN-6)
	LPC	1 x LPC (supports LPC EXT-RS232/RS485 module)	1 x LPC (supports LPC EXT-RS232/RS485 module)
	DIO	1 x 16-bit DIO	1 x 16-bit DIO
	SMBus	1 x SMBus	1 x SMBus
WATCHDOG TIMER	Output & Interval	System Reset, Programmable via Software from 1 to 255 Seconds	System Reset, Programmable via Software from 1 to 255 Seconds
SECURITY	TPM	NUVOTON TPM2.0 (opt., MOQ required)	NUVOTON TPM2.0 (opt., MOQ required)
POWER	Type	ATX	ATX
	Connector	8-pin ATX 12V power 24-pin ATX power	8-pin ATX 12V power 24-pin ATX power
	Consumption	Typical: i9-10900K: 3.3V @ 0.17A (0.56W); 5V @ 0.74A (3.7W); 12V @ 0.41A (4.92W) Max.: i9-10900K: 3.3V @ 0.21A (0.69W); 5V @ 1.73A (8.65W); 12V @ 12.48A (149.76W)	Typical: i9-10900K: 3.3V @ 0.17A (0.56W); 5V @ 0.74A (3.7W); 12V @ 0.41A (4.92W) Max.: i9-10900K: 3.3V @ 0.21A (0.69W); 5V @ 1.73A (8.65W); 12V @ 12.48A (149.76W)
	RTC Battery	CR2032 Coin Cell	CR2032 Coin Cell
OS SUPPORT	Microsoft	Windows 10 IoT Enterprise 64-bit Windows Server 2019 (opt. only support Intel® i210)	Windows 10 IoT Enterprise 64-bit Windows Server 2019 (opt. only support Intel® i210)
	Linux	Linux	Linux
ENVIRONMENT	Temperature	Operating: -5 to 65°C Storage: -30 to 60°C with RTC Battery; -40 to 85°C without RTC Battery	Operating: -5 to 65°C Storage: -30 to 60°C with RTC Battery; -40 to 85°C without RTC Battery
	Humidity	492,929 hrs @ 25°C ; 274,924 hrs @ 45°C ; 171,243 hrs @ 60°C Calculation Model: Telcordia Issue 4 Environment: GB, GC - Ground Benign, Controlled	492,929 hrs @ 25°C ; 274,924 hrs @ 45°C ; 171,243 hrs @ 60°C Calculation Model: Telcordia Issue 4 Environment: GB, GC - Ground Benign, Controlled
	MTBF	Operating: 5 to 95% RH Storage: 5 to 95% RH	Operating: 5 to 95% RH Storage: 5 to 95% RH
MECHANISM	Dimensions	ATX Form Factor 305mm (12") x 244mm (9.6")	ATX Form Factor 305mm (12") x 244mm (9.6")
	Height	PCB: 1.6mm Top Side: 33.3mm Bottom Side: 4mm	PCB: 1.6mm Top Side: 33.3mm Bottom Side: 4mm
CERTIFICATIONS	Certifications	CE, FCC Class B, RoHS, UKCA	CE, FCC Class B, RoHS, UKCA

ORDERING INFORMATION

Model Name	P/N	Memory	GbE	M.2	RS-232/422/485	USB 3.2 Gen2	USB 3.2 Gen1	USB 2.0	SATA	TPM 2.0	Power	Temp.
CMS632-W480ECRM	770-CMS6321-000G	4 DDR4 UDIMM	2	2	2	4	6	13	4	0	24-pin ATX/ 8-pin ATX 12V	-5 to 65°C
CMS632-Q470ECRM	770-CMS6321-100G									0		
CMS632-W480ECRM	770-CMS6321-200G									1		
CMS632-Q470ECRM	770-CMS6321-300G									1		

PACKING LIST

• 1 CMS632 motherboard	
• 1 COM port cables (Length: 300mm, 2 x COM ports)	A81-015026-023G
• 1 Serial ATA data cable (Length: 500mm)	332-553001-005G
• 1 I/O shield	A49-CMS630-000G
• 1 M.2 screw/standoff	A32-112016-041G

OPTIONAL ITEMS

• USB 2.0 port cable (Length: 350/398mm)	A81-001066-016G
• USB 3.2 Gen2 port cable (Length: 300mm)	A81-001075-017G
• COM port cable (Length: 300mm, 2 x COM ports)	A81-015026-023G
• Serial ATA data cable (Length: 500mm, W/LOCK)	332-553001-005G
• Serial ATA data cable (Length: 500mm, W/LOCK, 90D)	A81-002128-017G
• Thermal solution (For 35W, Height: 37.3mm)	A71-101107-000G
• Thermal solution (For 65W, Height: 74.47mm)	A71-101158-000G
• Thermal solution (For 95W, Height: 77.2mm)	761-103001-000G
• DP to HDMI Dongle	612-D2H13M-000G
• PS2 KB/MS Cable (Length: 400mm)	332-353016-009G
• EXT-RS232 (4 ports RS-232 LPC module)	770-EXTRS1-000G
• EXT-RS485 (4 ports RS-485 LPC module)	770-EXTRS1-100G
• M.2-COM4 (M.2 serial port module)	770-M2COM1-000G
• M.2-2LAN (M.2 LAN port module)	770-M22LN2-000G
• M.2-2PSE (M.2 PSE module)	770-M22PS1-000G