

Varistar CP for Rail Communications

CONNECT AND PROTECT

Flexible Electronics Cabinet For Railway Technical Rooms

The nVent SCHROFF Varistar CP electronics cabinet platform enables OEM deliver extremely modifiable and competitively priced control room enclosures for applications such as Security Surveillance, Passenger Information Systems, SCADA and General Communications systems.

Customers value nVent SCHROFF for their global manufacturing capability, design support throughout projects and ultimately for high performance railway certified cabinets that can be easily modified to meet various application requirements and also to reflect individual brand identity.

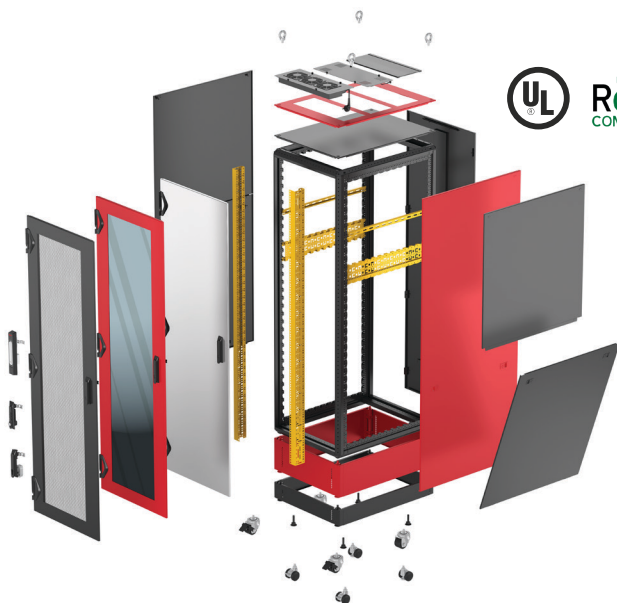
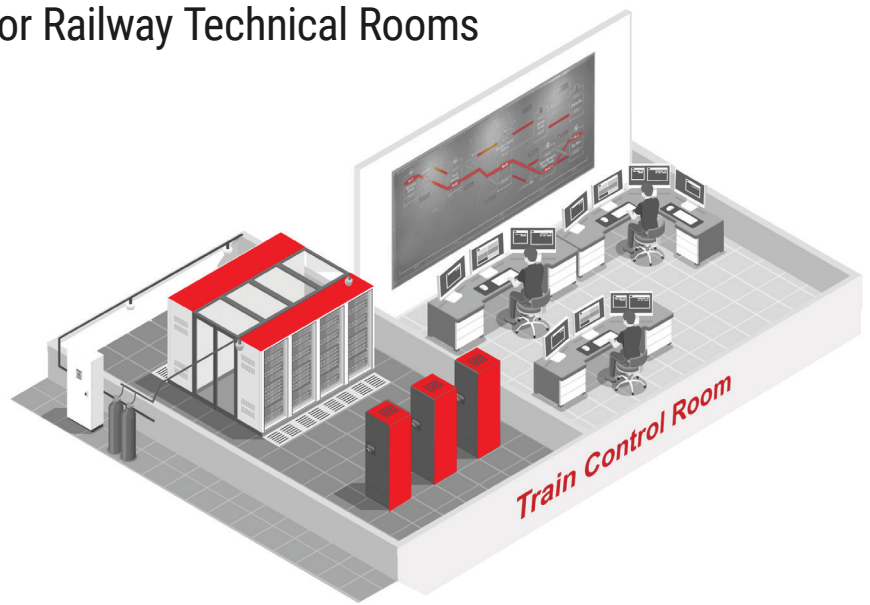

BUILT IN FLEXIBILITY

Rail IT Room Applications

The nVent SCHROFF Varistar CP cabinet has a robust, welded frame and is specifically designed for railways technical/control rooms:

- Streamlined design and universal manufacturing ability for global IT applications in Rail
- Unique meander type profile for maximum fixing flexibility for of active and passive network components
- One tool required as all screws are TORX 30
- Designed to ensure easy one person mounting possibilities
- Tested for static load capacity of 1,600 Kg and dynamic load capacity with integrated castors of 1,000 Kg

OPTIMIZED COOLING SOLUTIONS

Depending on the amount of heat generated and the internal and external ambient temperatures, multiple cooling options are available as standard to ensure effective cooling.

Closed cabinet

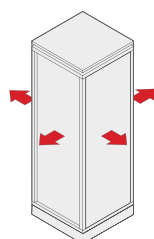

Natural convection via thermal radiation

Raised cover, ventilation slots

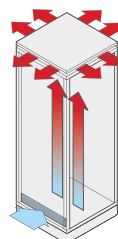

Free convection through top-cover opening

Perforated doors

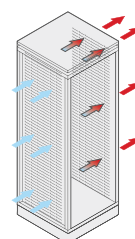

Free convection through opening in the doors/rear panels

19" fans, top-cover fans

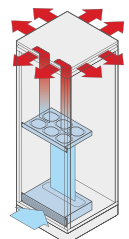

Forced cooling with air

LOCKING & SECURITY SOLUTIONS

Varistar CP IP20 cabinets come with multiple locking options. The ergonomic handles come in the following variants:

- Lock handles with round cylinder 1333
- Combination of code and round cylinder 1333
- Lock handles with DIN profile half cylinder
- Electronic locks – MLR 1000, 3000 and 5000
- Compatible with KABA cylinder
- Compatible with Scandinavian oval cylinder



Please find the Varistar CP compliant locks here:
Handles and Locks | nVent

EFFICIENT CABLE MANAGEMENT

Varistar CP IP20 cabinets come with effective and a wide array of cabling options

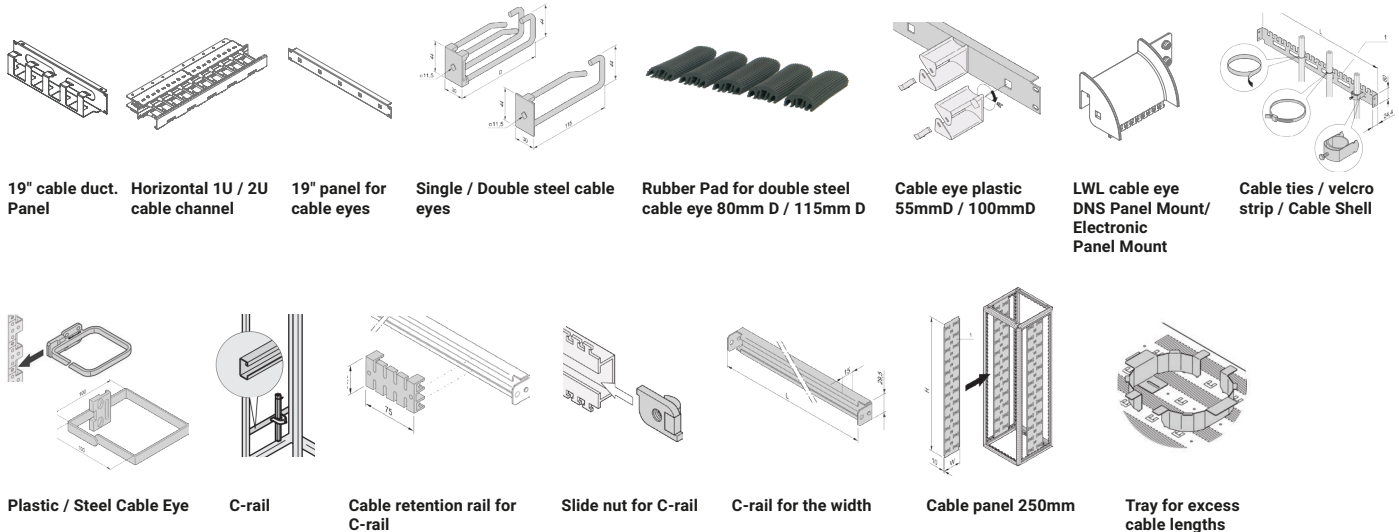

19" cable duct. Panel

Horizontal 1U / 2U cable channel

19" panel for cable eyes

Single / Double steel cable eyes

Rubber Pad for double steel cable eye 80mm D / 115mm D

Cable eye plastic 55mmD / 100mmD

LWL cable eye DNS Panel Mount/ Electronic Panel Mount

Cable ties / velcro strip / Cable Shell

Plastic / Steel Cable Eye

C-rail

Cable retention rail for C-rail

Slide nut for C-rail

C-rail for the width

Cable panel 250mm

Tray for excess cable lengths

Please find our complete assortment here: **Cable Managers | nVent**

INNOVATIVE CASTOR DESIGN

Varistar CP IP20 cabinets have a new innovative castor design for typical networking enclosure with improved load capacity

- Tested for dynamic load capacity of 1,000 Kg with integrated castors
- Special frame design for non-protruding castors, adding to the aesthetics
- Enables moving the completely mounted enclosure for maintenance without fork lifts
- Rubber castors protect your floors from scratches and maintenance



Standard robust rollers tested up to 1,000 Kg

Caster ø125mm with rubberized roller

Please find our castors assortment for Varistar CP here: **Castors | nVent**

EUROPE

Straubenhardt, Germany
Tel +49.7082.794.0

Betschdorf, France
Tel +33.388.90.64.90

Warsaw, Poland
Tel +48.22.209.98.35

Assago, Italy
Tel +39.02.5776151.224

NORTH AMERICA

All locations
Tel: +1.763.422.2661

MIDDLE EAST & INDIA

Dubai, United Arab Emirates
Tel +971.4.37.81.700

Bangalore, India
Tel: +91.80.6715.2001

Istanbul, Turkey
Tel: +90.216.250.7374

ASIA

Shanghai, P.R. China
Tel +86.21.2412.6943

Qingdao, P.R. China
Tel +86.523.8771.6101

Singapore
Tel +65.6768.5800

Shin-Yokohama, Japan
Tel +81.45.476.0271



Our powerful portfolio of brands:

CADDY ERICO HOFFMAN RAYCHEM SCHROFF TRACER