

# **MLC**

## **2.5" Rugged Metal**

## **SATA III SSD**

### **BON-III Series**

**(Supports Fast & Secure Erase)**



**Document No. :** 100-xR2SR-MSTMB

**Version No. :** 02V3

**Date :** June, 2019

ISO 9001 : 2015 CERTIFIED



### Product Features

#### ■ Flash IC

- TOSHIBA 15nm NAND Flash IC.
- Multi-Level Cell (MLC) management

#### ■ Compatibility

- Compliant with SATA Revision 3.1
- Compliance with Existing Sanitize (Purge) Standards by software vendor commands.
- SATA 1.5Gb/s; SATA 3Gb/s & SATA 6Gb/s Interface compatible.
- ATA-8 ACS2 command set
- Compliance with Existing Sanitize (Purge) Standards by software vendor commands.

#### ■ Additional Capabilities

- Support Software command set for FE/SE function
- Supports Hardware Trigger for FE/SE function
- Supports Hardware jumper setting for Write Protect function
- Support Full-Drive Encryption.
- S.M.A.R.T. (Self-Monitoring, Analysis and Reporting Technology) feature set support.
- Native Command Queuing (NCQ) support.
- TRIM maintenance command support.
- Support Global wear-leveling algorithm
- Designed with a DRAM buffer which is support high transfer rate
- Power interrupts data protection technology by Tantalum Capacitors.
- Support Bad Block Management

#### ■ Mechanical

- Standard 2.5" SATA Flash Disk form-factor (7mm)
- SATA 7-pin (data) + 15-pin (power connector) SATA Interface
- Dimension: 100.0mm x 70.0mm x 9.2mm.
- Weight: 100.0 g / 3.52 oz.

#### ■ Power Operating Voltage 5V(+/-) 5%

- Read Mode: 350.0 mA. (max.)
- Write Mode: 580.0 mA. (max.)
- Idle Mode: 120.0 mA. (max.)

#### ■ Performance (Maximum value) \*1

- Sequential Read: 561 MB/sec. (max.)
- Sequential Write: 349 MB/sec. (max.)
- 4KB Random Read IOPS (QD32): 71.7K
- 4KB Random Write IOPS (QD32): 68.7K
- 4KB Random Read access time: 0.13ms
- 4KB Random Write access time: 0.05ms

#### ■ Capacity

- 32GB, 64GB, 128GB, 256GB, 512GB and 1TB

#### ■ Reliability

- **TBW:** Up to 1,800 TBW at 1TB Capacity.  
(Client workload by JESD-219A)
- **ECC:** Hardware BCH ECC capable of correcting errors up to 66-bit/1KB
- **Temperature:** (Operating)  
Standard Grade: 0°C ~ +70°C  
Wide Temp. Grade: -40°C ~ +85°C
- **Vibration:** 70 Hz to 2000 Hz, 15G, 3 axes.
- **Shock:** 0.5ms, 1500 G, 3 axes.

#### ■ Certifications and Declarations

- **Certifications:** CE & FCC
- **Declarations:** RoHS & REACH

#### Remarks:

1. Sequential performance is based on CrystalDiskMark 5.1.2 with file size 1000MB

### Order Information

#### I. Part Number List

##### ◆ APRO MLC 2.5" Rugged Metal SATA III SSD BON-III series

Product Picture	Grade	Standard grade (0°C ~ 70°C)	Wide Temp Grade ( -40°C ~ +85°C )
	32GB	SR2SR032G-MSCTMB-UFE(USE)P	WR2SR032G-MSCTMBUFE(USE)PC
	64GB	SR2SR064G-MSCTMB-UFE(USE)P	WR2SR064G-MSCTMBUFE(USE)PC
	128GB	SR2SR128G-MSCTMB-UFE(USE)P	WR2SR128G-MSCTMBUFE(USE)PC
	256GB	SR2SR256G-MSCTMB-UFE(USE)P	WR2SR256G-MSCTMBUFE(USE)PC
	512GB	SR2SR512G-MSCTMB-UFE(USE)P	WR2SR512G-MSCTMBUFE(USE)PC
	1TB	SR2SR001T-MSCTMB-UFE(USE)P	WR2SR001T-MSCTMBUFE(USE)PC

#### Notes:

C : Special conformal coating treated on whole PCBA which may support wide temp. grade operating temperature -40°C ~ +85°C

#### II. Part Number Decoder:

**X1 X2 X3 X4 X5 X6 X7 X8 X9**—**X11 X12 X13 X14 X15 X16 X17 X18 X19 X20 X21**

#### **X1** : Grade

S: Standard Grade – operating temp. 0° C ~ 70 ° C

W: Wide Temp Grade- operating temp. -40° C ~ +85 ° C

#### **X2** : The material of case

R : Rugged Metal

#### **X3 X4 X5** : Product category

2SR : 2.5" SATA SSD w/SDRAM cache

#### **X6 X7 X8 X9** : Capacity

032G: 32GB      256G: 256GB

064G: 64GB      512G: 512GB

128G: 128GB      001T: 1TB

#### **X11** : Controller

M : BON-III Series

#### **X12** : Controller version

A, B, C.....

#### **X13** : Controller Grade

C : Commercial grade

#### **X14** : Flash IC

T : Toshiba MLC-NAND Flash IC

#### **X15** : Flash IC grade / Type

M : MLC -NAND Flash IC

#### **X16** : MLC Technology

B : Toshiba 15nm MLC

#### **X17 X18 X19** : Special function

UFE : Fast Erase function

USE: Secure Erase function

#### **X20** : Special function

P : Full-Drive Encryption

#### **X21** : Reserved for specific requirement

C : Conformal-coating (optional)

## *Revision History*

Revision	Description	Date
1.0	Initial release	2016/09/14
1.1	Add FE/SE Command Set	2018/07/31
1.2	Updated Version	2018/11/28
2.1	Add Support Full-Drive Encryption function decryption.	2019/03/25
2.2	Updated Document Format	2019/06/06
2.3	Corrected Part-Number Decorer	2019/11/26

### Contents

Product Features .....	2 -
Order Information .....	3 -
<b>I. Part Number List</b> .....	3 -
<b>II. Part Number Decoder:</b> .....	3 -
Revision History .....	4 -
Contents .....	5 -
<b>1. Introduction</b> .....	7 -
<b>1.1. Scope</b> .....	8 -
<b>1.2. Flash Management Technology – Global Wear Leveling</b> .....	8 -
<b>1.3. Bad Block Management</b> .....	8 -
<b>1.4. DRAM Buffer</b> .....	8 -
<b>1.5. Power Interrupt Data Protection Technology</b> .....	9 -
<b>1.6. Full-Drive Encryption</b> .....	9 -
<b>2. Product Specifications</b> .....	10 -
<b>2.1. System Environmental Specifications</b> .....	10 -
<b>2.2. System Power Requirements</b> .....	10 -
<b>2.3. System Performance</b> .....	10 -
<b>2.4. System Reliability</b> .....	11 -
<b>2.5. Physical Specifications</b> .....	11 -
<b>2.6. Conformal coating</b> .....	13 -
<b>3. Interface Description</b> .....	13 -
<b>3.1. 2.5" Rugged Metal SATA III SSD BON-III series interface</b> .....	13 -
<b>3.2. Pin Assignments</b> .....	14 -
<b>4. Hardware Configuration of FE/SE Function</b> .....	15 -
<b>4.1. Fast / Secure Erase Jumper</b> .....	15 -
<b>4.1.1. Fast Erase</b> .....	15 -
<b>4.1.2. Secure Erase</b> .....	15 -
<b>4.2. Default Setting</b> .....	16 -
<b>4.3. Write Protect Function</b> .....	16 -
<b>4.4. Secure Erase Standards</b> .....	17 -
<b>4.4.1. Auto-Resume Features</b> .....	17 -
<b>4.4.2. Random Data Written During the Sanitize Procedure</b> .....	17 -
<b>4.4.3. Protection Mechanism</b> .....	17 -
<b>4.4.4. Using the SSD After Sanitizing Procedure</b> .....	18 -
<b>4.4.5. Required Time for Secure Erase Function</b> .....	18 -
<b>5. Software Commands</b> .....	18 -
<b>5.1. Fast Erase</b> .....	19 -

5.1.1.	<i>Inputs for Enabling Fast Erase</i> .....	- 19 -
5.1.2.	<i>Outputs for Enabling Fast Erase</i> .....	- 19 -
5.2.	<i>Secure Erase (Sanitizing Procedures)</i> .....	- 20 -
5.2.1.	<i>NSA Manual 130-2</i> .....	- 20 -
5.2.1.1.	<i>Inputs for Enabling NSA Manual 130-2</i> .....	- 20 -
5.2.1.2.	<i>Outputs for Enabling NSA Manual 130-2</i> .....	- 20 -
5.2.2.	<i>USA-AF AFFSI 5020</i> .....	- 21 -
5.2.2.1.	<i>Inputs for Enabling USA-AF AFFSI 5020</i> .....	- 21 -
5.2.2.2.	<i>Outputs for Enabling USA-AF AFFSI 5020</i> .....	- 21 -
5.2.3.	<i>DoD 5220.22-M</i> .....	- 22 -
5.2.3.1.	<i>Inputs for Enabling DoD 5220.22-M</i> .....	- 22 -
5.2.3.2.	<i>Outputs for Enabling DoD 5220.22-M</i> .....	- 22 -
5.2.4.	<i>IRIG 106</i> .....	- 23 -
5.2.4.1.	<i>Inputs for Enabling IRIG 106</i> .....	- 23 -
5.2.4.2.	<i>Outputs for Enabling IRIG 106</i> .....	- 23 -
5.2.5.	<i>USA Navy NAVSO P-5239-26</i> .....	- 24 -
5.2.5.1.	<i>Inputs for Enabling USA Navy NAVSO P-5239-26</i> .....	- 24 -
5.2.5.2.	<i>Outputs for Enabling USA Navy NAVSO P-5239-26</i> .....	- 24 -
5.2.6.	<i>USA-Army 380-19</i> .....	- 25 -
5.2.6.1.	<i>Inputs for Enabling USA-Army 380-19</i> .....	- 25 -
5.2.6.2.	<i>Outputs for Enabling USA-Army 380-19</i> .....	- 25 -
5.2.7.	<i>NISPOMSUP Chap 8, Sect. 8-501</i> .....	- 26 -
5.2.7.1.	<i>Inputs for Enabling NISPOMSUP Chap 8, Sect. 8-501</i> .....	- 26 -
5.2.7.2.	<i>Outputs for Enabling NISPOMSUP Chap 8, Sect. 8-501</i> .....	- 26 -
<i>Appendix A: Limited Warranty</i> .....		- 27 -

### 1. Introduction

APRO MLC 2.5" Rugged Metal SATA III SSD BON-III series provides high capacity flash memory Solid State Drive (SSD) that electrically complies with Serial ATA 3.0 (SATA) standard. APRO MLC 2.5" Rugged Metal SATA III SSD BON-III series support SATA 1.5Gb/s; SATA 3Gb/s & SATA 6Gb/s data transfer rate with high performance, and designed with a DRAM which is support the data buffer for SSD. The available disk capacities are 32GB, 64GB, 128GB, 256GB, 512GB and 1TB.

The operating temperature grade is optional for Standard grade 0°C ~ 70°C and wide temp grade supports -40°C ~ +85°C. The data transfer performance by sequential read is up to 561.0 MB/sec, and sequential write is up to 349.0 MB/sec.

APRO MLC 2.5" Rugged Metal SATA III SSD BON-III series supports Fast Erase/Secure Erase which initiates by hardware design and software vendor commands. Fast Erase Procedure is one of the defaults sanitizing procedure in BON-III series. Fast Erase enables users to erase entire disk contents within seconds; 32GB SSD needs about 11.2 seconds, and 1TB needs about 70 seconds to run the fast erase procedure for whole disk completely.

APRO MLC 2.5" Rugged Metal SATA III SSD BON-III series built-in a 4Gbits DRAM (1TB built-in 8Gbit), provide a high level interface to the host computer. This interface allows a host computer to issue commands to the APRO MLC 2.5" Rugged Metal SATA III SSD BON-III series to read or write blocks of memory. Hardware BCH ECC capable of correcting errors up to 66-bit/1KB (ECC). APRO MLC 2.5" Rugged Metal SATA III SSD BON-III series intelligent controller manages interface protocols, data storage and retrieval as well as ECC, defect handling and diagnostics, power management and clock control.

Figure 1 shows a block diagram of the used high tech APRO MLC 2.5" Rugged Metal SATA III SSD BON-III series.

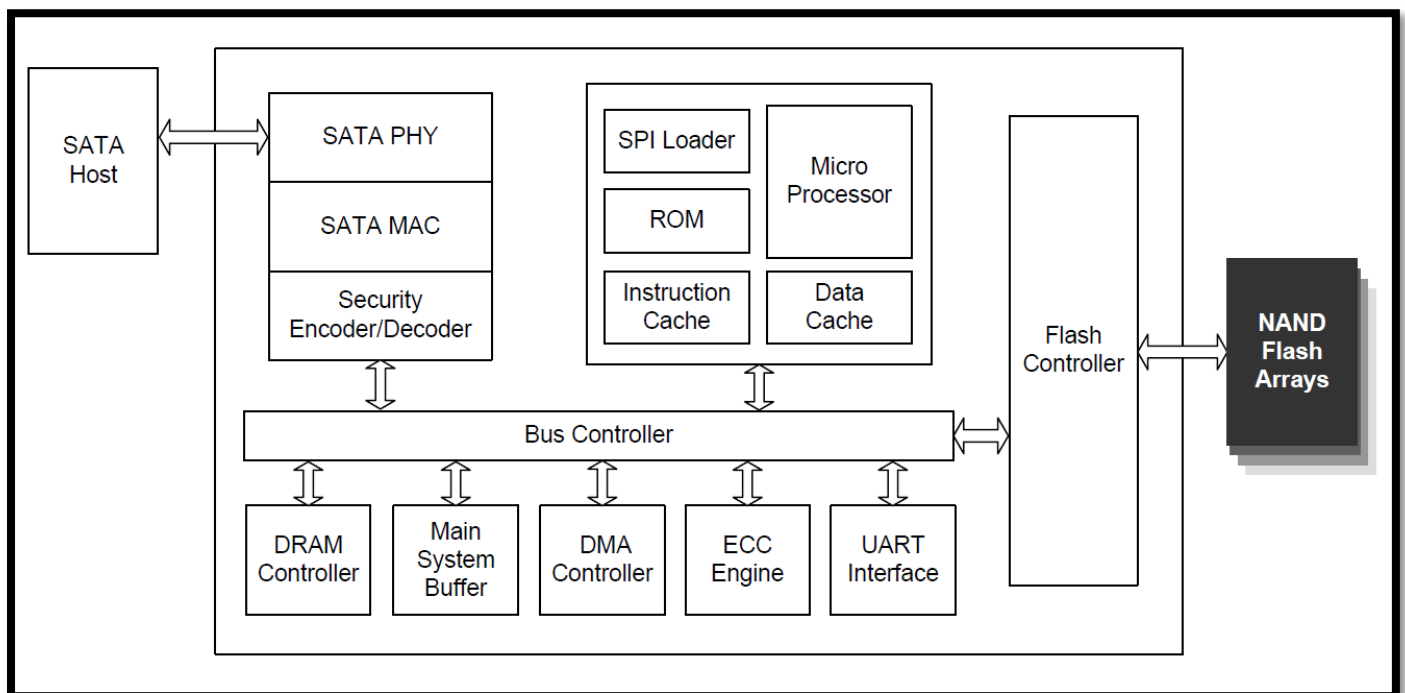

Figure 1: APRO MLC 2.5" Rugged Metal SATA III SSD BON-III series block diagram

### 1.1. Scope

This document describes features, specifications and installation guide of APRO MLC 2.5" Rugged Metal SATA III SSD BON-III series. In the appendix, there provides order information, warranty policy, RMA/DOA procedure for the most convenient reference.

### 1.2. Flash Management Technology – Global Wear Leveling

In order to gain the best management for flash memory, APRO MLC 2.5" Rugged Metal SATA III SSD BON-III series applies Global Wear-leveling technology to manage the Flash system. The life of flash memory is limited; the management is to increase the life of the flash product. The objective of global wear leveling is to prevent any frequently updated data from staying at the static area so that wear leveling could be evenly applied to all blocks. Static areas contain any data that does not change, and are ignored by dynamic wear leveling. Such static data may include operating system files, table look-ups, executable files, and etc. Global wear leveling frequently replaces blocks in this area with block in the hot area, and thus each block in all areas has the same probability to be used.

Wear-leveling algorithm evenly distributes data over an entire Flash cell array and searches for the least used physical blocks. The identified low cycled sectors are used to write the data to those locations. If blocks are empty, the write occurs normally. If blocks contain data, it moves that data to a more heavily used location before it moves the newly written data. Wear leveling maximizes effective endurance Flash array compared to no wear leveling products.

### 1.3. Bad Block Management

#### ➤ Early Bad Block

The fault block generated during the manufacturing process of NAND Flash is called Early Bad Block.

#### ➤ Later Bad Block

In the process of use, as the number of operations of writing and erasing increases, a fault block is gradually generated, which is called a Later Bad Block.

**Bad block management** is a management mechanism for a bad block to be detected by the control IC and mark bad blocks in the NAND Flash and improve the reliability of data access. The bad block management mechanism of the control IC will establish a **Bad Block Table** when the NAND Flash is started for the first time, and will also record the errors found in the process of use in the bad block table, and data is ported to new valid blocks to avoid data loss.

In order to detect the initial bad blocks to handle run time bad blocks, APRO MLC 2.5" Rugged Metal SATA III SSD BON-III series provides the **Bad Block Management** scheme. It remaps a bad block to one of the reserved blocks so that the data contained in one bad block is not lost and new data writes on a bad block is avoided.

### 1.4. DRAM Buffer

SSDs designed with a DRAM buffer which is support high transfer rate as a data buffer for the SSD; SSD with DRAM buffer is able to deliver excellent random data transfer speed.

- 32GB to 256GB Supports 4GBits DRAM Cache
- 512GB & 1TB Supports 8GBits DRAM Cache.



### 1.5. **Power Interrupt Data Protection Technology**

In the event of an unstable power supply, SSD loses power before it can finish programming process from host to flash, this may cause data being written to the incorrect block and further leads to data corruption.

Power Interrupt Data Protection Technology is applied with several tantalum capacitors to provide power buffering after host power interruption. The Data Protection Technology provides enough time for the SSD controller can write all DRAM buffer data to flash, all data will be protected and without data loss.

The ability of Power Interrupt Data Protection Technology is able to write 1.28MB of data within 60ms.

This ensures all data in the DRAM buffer can be successfully written into flash.

Traditionally, super capacitors were applied in most SSD products, the advantages of tantalum capacitors over super capacitors are:

➤ **Tantalum capacitors are electrolyte free.**

It is able to maintain its designed capacitance for several years when used within design limits.

➤ **Wide operating temperature range.**

Tantalum capacitors can operate from temperature range of -55C to +125C, which is very suitable for Wide Temp. and military usage.

➤ **Tantalum capacitors have an ultimate high volumetric efficiency (CV/cc).**

For example, a 50-microfarad tantalum capacitor can be equal and to properly replace a 500-microfarad aluminum capacitor.

### 1.6. **Full-Drive Encryption**

➤ Supports real time Full Disk Encryption (FDE) with Advanced Encryption Standard (AES) 128/256-bit strength Supports Trusted Computing Group (TCG) Opal protocol

➤ Supports Default/Partition Key function up to 8 keys

➤ Supports Hardware SHA 256 and True Random Number Generator (TRNG)

Notice: Customer / Engineer must have the AES relevant knowledge and the skill to write programs for their own application.

### 2. Product Specifications

For all the following specifications, values are defined at ambient temperature and nominal supply voltage unless otherwise stated.

#### 2.1. System Environmental Specifications

Table 1: Environmental Specification

APRO MLC 2.5" Rugged Metal SATA III SSD		Standard Grade	Wide Temp Grade
BON-III series		SR2SRxxxG-MSCTMB-UFE(USE)	WR2SRxxxG-MSCTMBUFE(USE)C
Temperature	Operating:	0°C ~ +70°C	-40°C ~ +85°C
	Non-operating:	-20°C ~ +80°C	-50°C ~ +95°C
Humidity	Operating & Non-operating:	10% ~ 95% non-condensing	
Vibration	Frequency/Acceleration:	70 Hz to 2000 Hz, 15G, 3 axes	
Shock	Operating & Non-operating:	0.5ms, 1500 G, 3 axes	
Electrostatic Discharge (ESD)	Temperature:	24°C	
	Relative Humidity:	49% (RH)	
	+/-4KV:	Device functions are affected, but EUT will be back to its normal or operational state automatically.	

#### 2.2. System Power Requirements

Table 2: Power Requirement

APRO MLC 2.5" Rugged Metal SATA III SSD BON-III series		
DC Input Voltage (VCC)	5V±5%	
Maximum average value	Reading Mode :	350.0 mA. (max.)
	Writing Mode :	580.0 mA. (max.)
	During FE/SE :	330.0 mA. (max.)
	Idle Mode :	120.0 mA. (max.)

#### 2.3. System Performance

Table 3: System Performances

Data Transfer Mode supporting		Serial ATA Gen-III (6.0Gb/s = 768MB/s)					
4KB Random access time	Read:	0.13 ms.					
	Write:	0.05 ms.					
Maximum Performance	Capacity	32GB	64GB	128GB	256GB	512GB	1TB
	Sequential Read (MB/s)	566.0	546.0	559.7	560.3	561.0	561.0
	Sequential Write(MB/s)	101.2	89.7	320.4	320.3	350.3	349.0
	4KB Random Read IOPS (QD32)	52.7K	50.1K	72.6K	72.4K	71.6K	71.7K
	4KB Random Write IOPS (QD32)	24.7K	21.8K	71.2K	71.5K	68.6K	68.7K

Note:

1. The performance was measured using CrystalDiskMarkv5.0x64 with SATA 6Gbps host.
2. Samples were built using Toshiba 15nm MLC
3. Performance may differ according to flash configuration and platform.

### 2.4. System Reliability

**Table 4: System Reliability**

<b>Wear-leveling Algorithms</b>	Global wear-leveling algorithms	
<b>Bad Block Management</b>	Supportive	
<b>ECC Technology</b>	Hardware BCH ECC capable of correcting errors up to 66-bit/1KB (ECC).	
<b>Erase counts</b>	NAND MLC Flash Cell Level : 3K P/E Cycles	
<b>TBW (Tera Bytes Written)</b>		
<b>Capacity</b>	<b>32GB</b>	55.0
	<b>64GB</b>	110.0
	<b>128GB</b>	230.0
	<b>256GB</b>	450.0
	<b>512GB</b>	900.0
	<b>1TB</b>	1,800.0

Note:

- Samples were built using Toshiba 15nm Toggle MLC NAND flash.
- The test followed JEDEC219A client endurance workload.
- The endurance of SSD could be estimated based on user behavior, NAND endurance cycles, and write amplification factor.  
It is not guaranteed by flash vendor.

### 2.5. Physical Specifications

Refer to Table 5 and see Figure 2 for APRO MLC 2.5" Rugged Metal SATA III SSD BON-III series physical specifications and dimensions.

**Table 5: Physical Specifications of APRO MLC 2.5" Rugged Metal SATA III SSD BON-III series**

<b>Length:</b>	100.0 mm
<b>Width:</b>	70.0 mm
<b>Thickness:</b>	9.20 mm
<b>Weight:</b>	100.0 g / 3.52 oz.

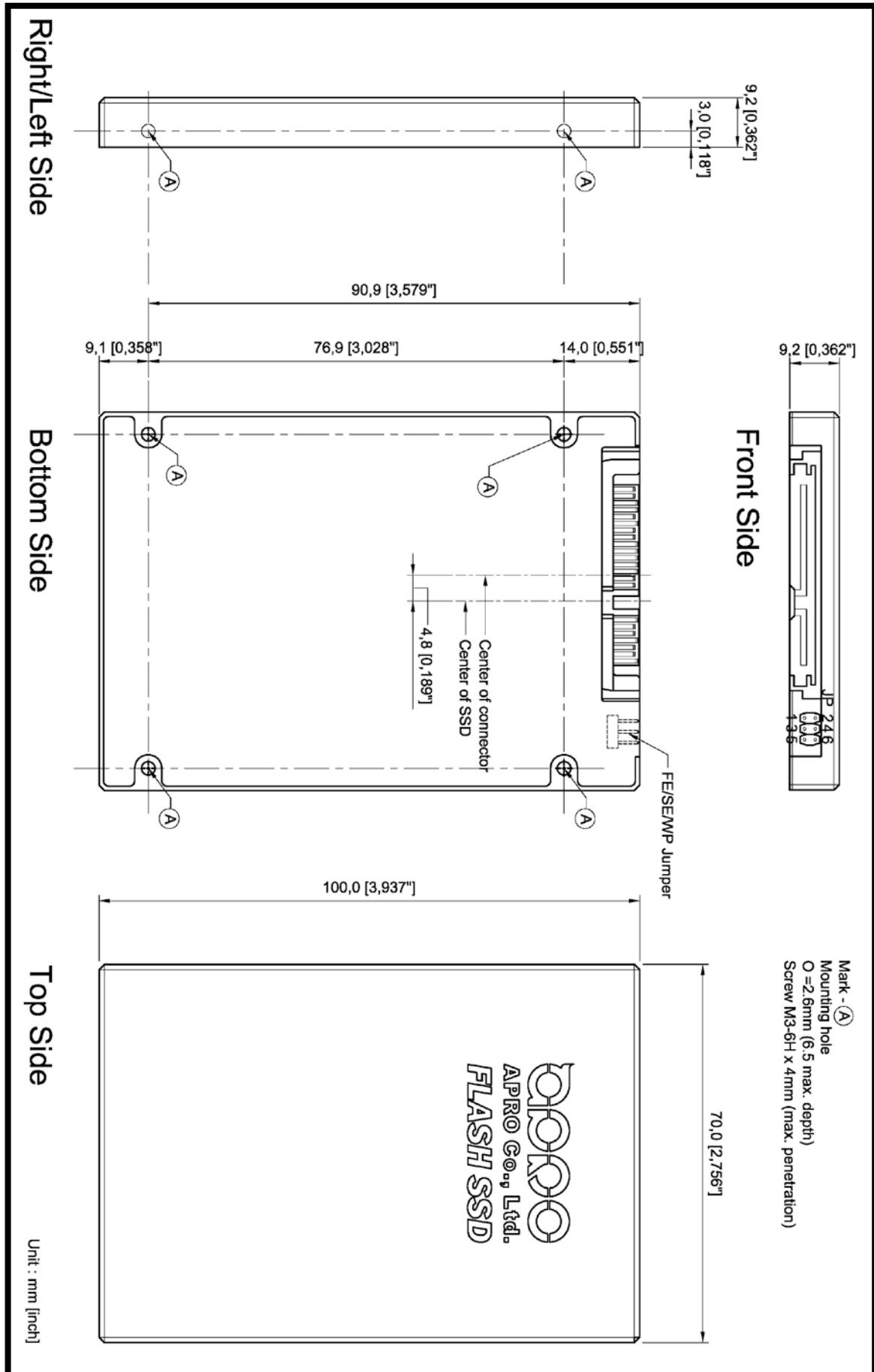

Figure 2: APRO MLC 2.5" Rugged Metal SATA III SSD BON-III series Dimension

### 2.6. Conformal coating

Conformal coating is a protective, dielectric coating designed to conform to the surface of an assembled printed circuit board. Commonly used conformal coatings include silicone, acrylic, urethane and epoxy. APRO applies only silicone on APRO storage products upon requested especially by customers. The type of silicone coating features good thermal shock resistance due to flexibility. It is also easy to apply and repair.

Conformal coating offers protection of circuitry from moisture, fungus, dust and corrosion caused by extreme environments. It also prevents damage from those Flash storages handling during construction, installation and use, and reduces mechanical stress on components and protects from thermal shock. The greatest advantage of conformal coating is to allow greater component density due to increased dielectric strength between conductors.

APRO use MIL-I-46058C silicon conformal coating

## 3. Interface Description

### 3.1. 2.5" Rugged Metal SATA III SSD BON-III series interface

APRO MLC 2.5" Rugged Metal SATA III SSD BON-III series is equipped with 7 pins in the signal segment and 15 pins in the power segment.

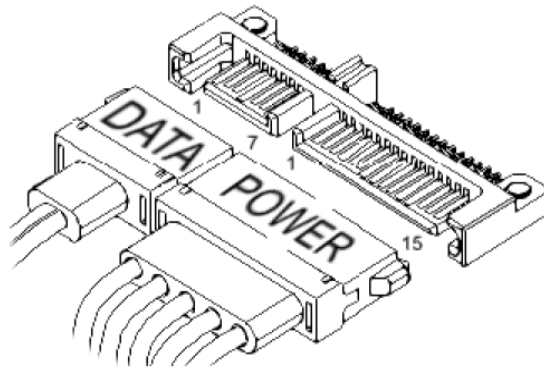

**Figure 3: The connectors of Signal Segment and Power Segment**

### 3.2. Pin Assignments

APRO MLC 2.5" Rugged Metal SATA III SSD BON-III series operates with standard SATA pin-out.

The pin assignments are listed in below table 6.

**Table 6 - Pin Assignments**

Name	Type	Description
S1	GND	NA
S2	A+	Differential Signal Pair A
S3	A-	
S4	GND	NA
S5	B-	Differential Signal Pair B
S6	B+	
S7	GND	NA

Key and Spacing separate signal and power segments		
P1	NC	NA
P2	NC	NA
P3	NC	NA
P4	GND	NA
P5	GND	NA
P6	GND	NA
P7	V5	5V Power, Pre-Charge
P8	V5	5V Power
P9	V5	5V Power
P10	GND	NA
P11	DAS/DSS	Device Activity Signal / Disable Staggered Spin up
P12	GND	NA
P13	NC	NA
P14	NC	NA
P15	NC	NA

### 4. Hardware Configuration of FE/SE Function

#### 4.1. Fast / Secure Erase Jumper

APRO MLC 2.5" Rugged Metal SATA III SSD BON-III series has several security features, such as fast erase, secure erase and a newly added write-protect function. These functions can be triggered by different hardware jumper settings or by ATA commands.

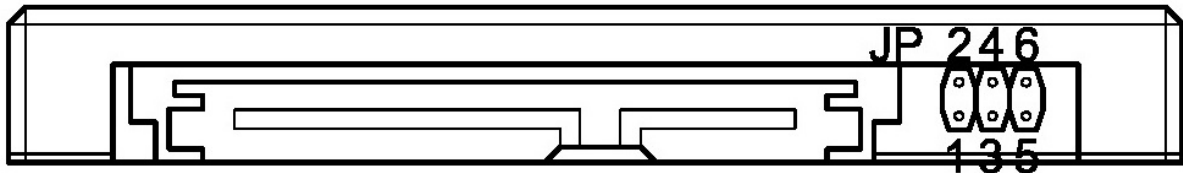

Figure 4: The jumper configuration of 2.5" SATA III MLC SSD

##### 4.1.1. Fast Erase

Fast Erase Procedure is one of the default sanitizing procedure in APRO Secure Erase SSD Series, it is trigger by placing jumper head on Pin-1 and Pin-2, SSD will be then become fully erased and filled with 0xFF and random data.

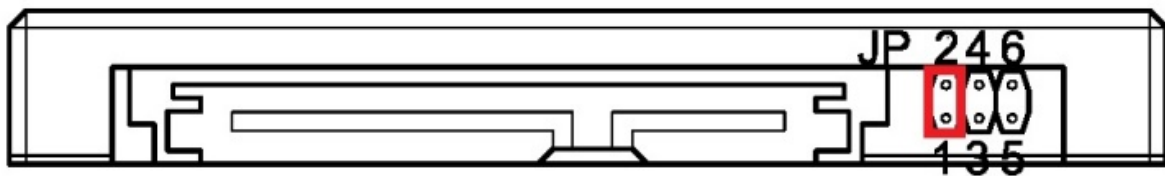

Figure 5: Fast Erase Jumper Setting

##### 4.1.2. Secure Erase

To execute Secure Erase function, jumper must be set on Pin-3 and Pin-4. APRO provide varieties of Secure Erase standard as options, customer may choose whichever is suitable for their application.

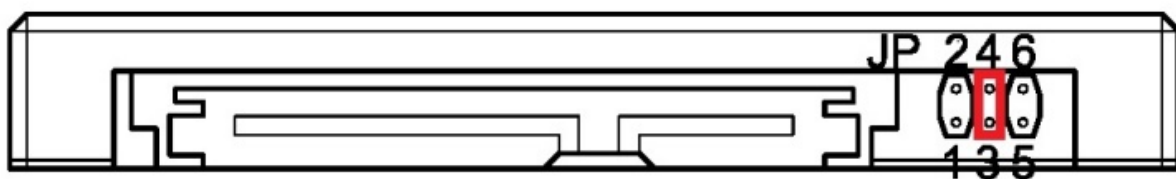

Figure 6: Secure Erase Jumper Setting

### 4.2. Default Setting

When security function is not required, jumper head should be placed on Pin-3 and Pin-5, SSD will not take any actions, it can be used as a normal storage device.

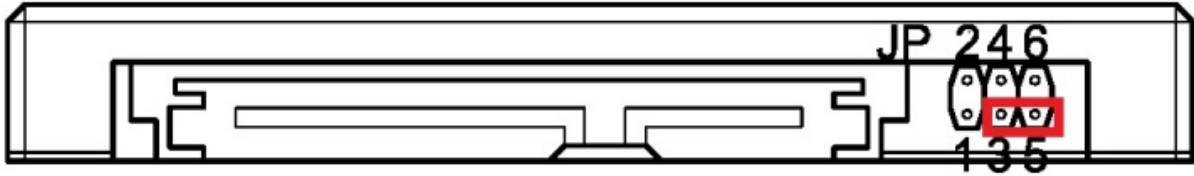

Figure 7: Default Setting

### 4.3. Write Protect Function

Write-Protect function can be enabled by setting the jumper head on Pin-5 and Pin-6, once it's enabled, it will abort any writing commands sent to the SSD. At this stage, SSD will become Read-Only and user will not be able to write or delete any data on the SSD.

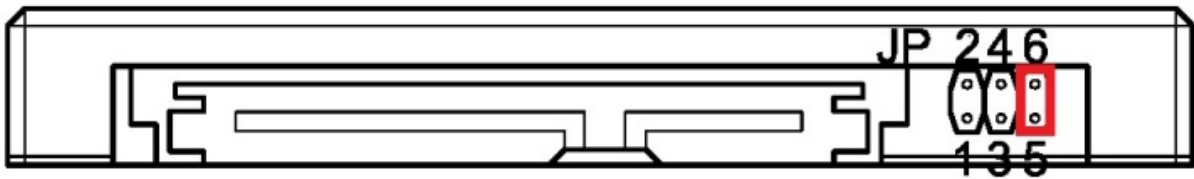

Figure 8: Write-Protect Function Jumper Setting



### 4.4. Secure Erase Standards

**Table 7 – Secure Erase Procedures**

Standard	Description
Fast Erase	<ol style="list-style-type: none"> <li>Erase all media</li> <li>fill with 0xFF and random data</li> </ol>
NSA Manual 130-2	<ol style="list-style-type: none"> <li>Erase the media</li> <li>Overwrite with random data twice</li> <li>Erase again</li> <li>Overwrite with 0x55</li> </ol>
USA-AF AFSSI 5020	<ol style="list-style-type: none"> <li>Erase the media</li> <li>Overwrite with random data</li> </ol>
DoD 5220.22-M	<ol style="list-style-type: none"> <li>Erase the media</li> <li>Overwrite with single character</li> <li>erase again</li> </ol>
IRIG 106	<ol style="list-style-type: none"> <li>Erase the media</li> <li>Overwrite with 0x55</li> <li>Erase</li> <li>Overwrite with 0xAA, erase</li> </ol>
USA Navy NAVSO P-5239-26	<ol style="list-style-type: none"> <li>Erase the media</li> <li>Overwrite with random data</li> <li>Erase again</li> </ol>
USA-Army 380-19	<ol style="list-style-type: none"> <li>Erase the media</li> <li>Overwrite with random data</li> <li>Fill with 0x55</li> <li>Overwrite again with 0xAA</li> </ol>
NISPOMSUP Chap 8, Sect. 8-501	<ol style="list-style-type: none"> <li>Filled with 0x55</li> <li>Overwrite with 0Xaa</li> <li>Overwrite again with random data</li> </ol>
NSA Manual 9-12	<ol style="list-style-type: none"> <li>Erase the media</li> <li>Overwrite with unclassified pattern</li> </ol>

#### 4.4.1. Auto-Resume Features

APRO MLC 2.5" Rugged Metal SATA III SSD BON-III series supports auto-resume features. When encounter power interruption during sanitizing procedure, it will automatically resume sanitizing at the next power-on until the whole procedure is finished.

#### 4.4.2. Random Data Written During the Sanitize Procedure

The random data used to overwrite user data is a digest of pseudo-random generation and real random data. The pseudo-random generation is seeded in such a manner that even if the SSD launches the Sanitize command under identical external conditions (for example, if the unit is powered on with Sanitize Interrupt active), it will produce different seeds and different pseudo-random data.

#### 4.4.3. Protection Mechanism

The protection mechanism only allows customer to activate Fast Erase and Secure Erase once for each power-on cycle.

This is to protect APRO's SSD from being erased continuously and can indirectly extend the lifetime of flash. If user wishes to activate erase function again, power must be disconnect and then reconnect again.

### 4.4.4. Using the SSD After Sanitizing Procedure

After Fast Erase or Secure Erase is finished, storage must be reinitialized and partition should be rebuilt in order to be used again.

### 4.4.5. Required Time for Secure Erase Function

**Table 8 – Erase time for all standard and capacities**

Capacity	32GB	64GB	128GB	256GB	512GB	1TB
Fast Erase	11.2 secs	22.5 secs	27.6 secs	27.6 secs	49.3 secs	70 secs

Note: Erase time by other Secure Erase Standard must test by customer's own system.

## 5. Software Commands

The interface specified in **Table 8** enables defining a wide range of Sanitize procedures.

**Table 9 – Command Set of Secure Erase Procedures**

Standard	Description	Command (Register: Command)	Master Command (Register: Sector count)
Fast Erase	<ol style="list-style-type: none"> <li>Erase all media</li> <li>fill with 0xFF</li> </ol>	82h	00h
NSA Manual 130-2	<ol style="list-style-type: none"> <li>Erase the media</li> <li>Overwrite with random data twice</li> <li>Erase again</li> <li>Overwrite with 0x55</li> </ol>	82h	81h
USA-AF AFSSI 5020	<ol style="list-style-type: none"> <li>Erase the media</li> <li>Overwrite with random data</li> </ol>	82h	41h
DoD 5220.22-M	<ol style="list-style-type: none"> <li>Erase the media</li> <li>Overwrite with single character</li> <li>erase again</li> </ol>	82h	84h
IRIG 106	<ol style="list-style-type: none"> <li>Erase the media</li> <li>Overwrite with 0x55</li> <li>Erase</li> <li>Overwrite with 0xAA, erase</li> </ol>	82h	D0h
USA Navy NAVSO P-5239-26	<ol style="list-style-type: none"> <li>Erase the media</li> <li>Overwrite with random data</li> <li>Erase again</li> </ol>	82h	85h
USA-Army 380-19	<ol style="list-style-type: none"> <li>Erase the media</li> <li>Overwrite with random data</li> <li>Fill with 0x55</li> <li>Overwrite again with 0xAA</li> </ol>	82h	C1h
NISPOMSUP Chap 8, Sect. 8-501	<ol style="list-style-type: none"> <li>Filled with 0x55</li> <li>Overwrite with 0Xaa</li> <li>Overwrite again with random data</li> </ol>	82h	D1h

### 5.1. Fast Erase

Below states the procedures of Fast Erase function.

- Erase all media.
- Fill with 0xFF.

#### 5.1.1. Inputs for Enabling Fast Erase

Table 10 – Input Fast Erase Command Code (Enable)

Register	7	6	5	4	3	2	1	0
Features	NA							
Sector count	00h							
LBA Low	NA							
LBA Mid	NA							
LBA High	NA							
Device	1	1	1	0	NA			
Command	82h							

#### 5.1.2. Outputs for Enabling Fast Erase

Table 11 – Output Fast Erase Command Code (Enable)

Register	7	6	5	4	3	2	1	0
Error	NA							
Sector count	NA							
LBA Low	NA							
LBA Mid	NA							
LBA High	NA							
Device	obs	NA	obs	DEV	NA	NA	NA	NA
	1	1	1	0				
Status	BSY	DRDY	DF	NA	DRQ	NA	NA	ERR
	0	1	0	1	0	0	0	0

#### Device register

**DEV** - shall specify the selected device.

Status register

**BSY** - will be cleared to zero indicating command completion

**DRDY** - will be set to one.

**DF** (Device Fault) - will be cleared to zero.

**DRQ** - will be cleared to zero.

**ERR** - will be cleared to zero.

### 5.2. Secure Erase (Sanitizing Procedures)

#### 5.2.1. NSA Manual 130-2

Below lists the Secure Erase procedures of NSA Manual 130-2.

- Erase all media.
- Fill with random data twice.
- Erase all media.
- Fill with 0x55

##### 5.2.1.1. Inputs for Enabling NSA Manual 130-2

Table 12 – Input NSA Manual 130-2 Command Code (Enable)

Register	7	6	5	4	3	2	1	0
Features	NA							
Sector count	81h							
LBA Low	NA							
LBA Mid	NA							
LBA High	NA							
Device	1	1	1	0	NA			
Command	82h							

##### 5.2.1.2. Outputs for Enabling NSA Manual 130-2

Table 13 – Output NSA Manual 130-2 Command Code (Enable)

Register	7	6	5	4	3	2	1	0
Error	NA							
Sector count	NA							
LBA Low	NA							
LBA Mid	NA							
LBA High	NA							
Device	obs	NA	obs	DEV	NA	NA	NA	NA
	1	1	1	0				
Status	BSY	DRDY	DF	NA	DRQ	NA	NA	ERR
	0	1	0	1	0	0	0	0

#### Device register

**DEV** - shall specify the selected device.

Status register

**BSY** - will be cleared to zero indicating command completion

**DRDY** - will be set to one.

**DF** (Device Fault) - will be cleared to zero.

**DRQ** - will be cleared to zero.

**ERR** - will be cleared to zero.

### 5.2.2. USA-AF AFFSI 5020

Below lists the Secure Erase procedures of USA-AF AFFSI 5020.

- Erase all media.
- Fill with random data.

#### 5.2.2.1. Inputs for Enabling USA-AF AFFSI 5020

Table 14 – Input USA-AF AFFSI 5020 Command Code (Enable)

Register	7	6	5	4	3	2	1	0
Features	NA							
Sector count	41h							
LBA Low	NA							
LBA Mid	NA							
LBA High	NA							
Device	1	1	1	0	NA			
Command	82h							

#### 5.2.2.2. Outputs for Enabling USA-AF AFFSI 5020

Table 15 – Output USA-AF AFFSI 5020 Command Code (Enable)

Register	7	6	5	4	3	2	1	0
Error	NA							
Sector count	NA							
LBA Low	NA							
LBA Mid	NA							
LBA High	NA							
Device	obs	NA	obs	DEV	NA	NA	NA	NA
	1	1	1	0				
Status	BSY	DRDY	DF	NA	DRQ	NA	NA	ERR
	0	1	0	1	0	0	0	0

#### Device register

**DEV** - shall specify the selected device.

Status register

**BSY** - will be cleared to zero indicating command completion

**DRDY** - will be set to one.

**DF** (Device Fault) - will be cleared to zero.

**DRQ** - will be cleared to zero.

**ERR** - will be cleared to zero.

### 5.2.3. DoD 5220.22-M

Below lists the Secure Erase procedures of DoD 5220.22-M.

- Erase all media.
- Overwrite with random character.
- Erase all media.

#### 5.2.3.1. Inputs for Enabling DoD 5220.22-M

**Table 16 – Input DoD 5220.22-M Command Code (Enable)**

Register	7	6	5	4	3	2	1	0
Features	NA							
Sector count	84h							
LBA Low	NA							
LBA Mid	NA							
LBA High	NA							
Device	1	1	1	0	NA			
Command	82h							

#### 5.2.3.2. Outputs for Enabling DoD 5220.22-M

**Table 17 – Output DoD 5220.22-M Command Code (Enable)**

Register	7	6	5	4	3	2	1	0
Error	NA							
Sector count	NA							
LBA Low	NA							
LBA Mid	NA							
LBA High	NA							
Device	obs	NA	obs	DEV	NA	NA	NA	NA
	1	1	1	0				
Status	BSY	DRDY	DF	NA	DRQ	NA	NA	ERR
	0	1	0	1	0	0	0	0

#### Device register

**DEV** - shall specify the selected device.

Status register

**BSY** - will be cleared to zero indicating command completion

**DRDY** - will be set to one.

**DF** (Device Fault) - will be cleared to zero.

**DRQ** - will be cleared to zero.

**ERR** - will be cleared to zero.

### 5.2.4. IRIG 106

Below lists the Secure Erase procedures of IRIG 106.

- Erase all media.
- Fill with 0x55.
- Erase all media.
- Fill with 0xAA.
- Erase all media.

#### 5.2.4.1. Inputs for Enabling IRIG 106

Table 18 – Input IRIG 106 Command Code (Enable)

Register	7	6	5	4	3	2	1	0
Features	NA							
Sector count	D0h							
LBA Low	NA							
LBA Mid	NA							
LBA High	NA							
Device	1	1	1	0	NA			
Command	82h							

#### 5.2.4.2. Outputs for Enabling IRIG 106

Table 19 – Output IRIG 106 Command Code (Enable)

Register	7	6	5	4	3	2	1	0
Error	NA							
Sector count	NA							
LBA Low	NA							
LBA Mid	NA							
LBA High	NA							
Device	obs	NA	obs	DEV	NA	NA	NA	NA
	1	1	1	0				
Status	BSY	DRDY	DF	NA	DRQ	NA	NA	ERR
	0	1	0	1	0	0	0	0

#### Device register

**DEV** - shall specify the selected device.

Status register

**BSY** - will be cleared to zero indicating command completion

**DRDY** - will be set to one.

**DF** (Device Fault) - will be cleared to zero.

**DRQ** - will be cleared to zero.

**ERR** - will be cleared to zero.

**Sector Count** - The number of Erase Failure Block

### 5.2.5. USA Navy NAVSO P-5239-26

Below lists the Secure Erase procedures of USA Navy NAVSO P-5239-26.

1. Erase all media.
2. Overwrite with random data.
3. Erase all media.

#### 5.2.5.1. Inputs for Enabling USA Navy NAVSO P-5239-26

**Table 20 – Input USA Navy NAVSO P-5239-26 Command Code (Enable)**

Register	7	6	5	4	3	2	1	0
Features	NA							
Sector count	85h							
LBA Low	NA							
LBA Mid	NA							
LBA High	NA							
Device	1	1	1	0	NA			
Command	82h							

#### 5.2.5.2. Outputs for Enabling USA Navy NAVSO P-5239-26

**Table 21 – Output USA Navy NAVSO P-5239-26 Command Code (Enable)**

Register	7	6	5	4	3	2	1	0
Error	NA							
Sector count	NA							
LBA Low	NA							
LBA Mid	NA							
LBA High	NA							
Device	obs	NA	obs	DEV	NA	NA	NA	NA
	1	1	1	0				
Status	BSY	DRDY	DF	NA	DRQ	NA	NA	ERR
	0	1	0	1	0	0	0	0

#### Device register

**DEV** - shall specify the selected device.

Status register

**BSY** - will be cleared to zero indicating command completion

**DRDY** - will be set to one.

**DF** (Device Fault) - will be cleared to zero.

**DRQ** - will be cleared to zero.

**ERR** - will be cleared to zero.



### 5.2.6. USA-Army 380-19

Below lists the Secure Erase procedures of USA-Army 380-19.

1. Erase all media.
2. Overwrite with random data.
3. Fill with 0x55.
4. Fill with 0xAA

#### 5.2.6.1. Inputs for Enabling USA-Army 380-19

Table 22 – Input USA-Army 380-19 Command Code (Enable)

Register	7	6	5	4	3	2	1	0
Features	NA							
Sector count	C1h							
LBA Low	NA							
LBA Mid	NA							
LBA High	NA							
Device	1	1	1	0	NA			
Command	82h							

#### 5.2.6.2. Outputs for Enabling USA-Army 380-19

Table 23 – Output USA-Army 380-19 Command Code (Enable)

Register	7	6	5	4	3	2	1	0
Error	NA							
Sector count	NA							
LBA Low	NA							
LBA Mid	NA							
LBA High	NA							
Device	obs	NA	obs	DEV	NA	NA	NA	NA
	1	1	1	0				
Status	BSY	DRDY	DF	NA	DRQ	NA	NA	ERR
	0	1	0	1	0	0	0	0

#### Device register

**DEV** - shall specify the selected device.

Status register

**BSY** - will be cleared to zero indicating command completion

**DRDY** - will be set to one.

**DF** (Device Fault) - will be cleared to zero.

**DRQ** - will be cleared to zero.

**ERR** - will be cleared to zero.

### 5.2.7. NISPOMSUP Chap 8, Sect. 8-501

Below lists the Secure Erase procedures of NISPOMSUP Chap 8, Sect. 8-501.

1. Fill with 0x55.
2. Overwrite with 0xAA.
3. Overwrite with random data.

#### 5.2.7.1. Inputs for Enabling NISPOMSUP Chap 8, Sect. 8-501

**Table 24 – Input NISPOMSUP Chap 8, Sect. 8-501 Command Code (Enable)**

Register	7	6	5	4	3	2	1	0
Features	NA							
Sector count	D1h							
LBA Low	NA							
LBA Mid	NA							
LBA High	NA							
Device	1	1	1	0	NA			
Command	82h							

#### 5.2.7.2. Outputs for Enabling NISPOMSUP Chap 8, Sect. 8-501

**Table 25 – Output NISPOMSUP Chap 8, Sect. 8-501 Command Code (Enable)**

Register	7	6	5	4	3	2	1	0
Error	NA							
Sector count	NA							
LBA Low	NA							
LBA Mid	NA							
LBA High	NA							
Device	obs	NA	obs	DEV	NA	NA	NA	NA
	1	1	1	0				
Status	BSY	DRDY	DF	NA	DRQ	NA	NA	ERR
	0	1	0	1	0	0	0	0

#### Device register

**DEV** - shall specify the selected device.

Status register

**BSY** - will be cleared to zero indicating command completion

**DRDY** - will be set to one.

**DF** (Device Fault) - will be cleared to zero.

**DRQ** - will be cleared to zero.

**ERR** - will be cleared to zero.

### **Appendix A: Limited Warranty**

APRO warrants your MLC 2.5" Rugged Metal SATA III SSD BON-III Series against defects in material and workmanship for the life of the drive. The warranty is void in the case of misuse, accident, alteration, improper installation, misapplication or the result of unauthorized service or repair. The implied warranties of merchantability and fitness for a particular purpose, and all other warranties, expressed or implied, except as set forth in this warranty, shall not apply to the products delivered. In no event shall APRO be liable for any lost profits, lost savings or other incidental or consequential damages arising out of the use of, or inability to use, this product.

**BEFORE RETURNING PRODUCT, A RETURN MATERIAL AUTHORIZATION (RMA) MUST BE OBTAINED FROM APRO.**

Product shall be returned to APRO with shipping prepaid. If the product fails to conform based on customers' purchasing orders, APRO will reimburse customers for the transportation charges incurred.

#### **WARRANTY PERIOD:**

- **MLC ( Standard grade / Wide temp. grade )    2 years / Within 3K Erasing Counts**

This document is for information use only and is **subject to change without prior notice**. APRO Co., Ltd. assumes no responsibility for any errors that may appear in this document, nor for incidental or consequential damages resulting from the furnishing, performance or use of this material. No part of this document may be reproduced, transmitted, transcribed, stored in a retrievable manner or translated into any language or computer language, in any form or by any means, electronic, mechanical, magnetic, optical, chemical, manual or otherwise, without the prior written consent of an officer of APRO Co., Ltd.

All parts of the APRO documentation are protected by copyright law and all rights are reserved.

APRO and the APRO logo are registered trademarks of APRO Co., Ltd.

Product names mentioned herein are for identification purposes only and may be trademarks and/or registered trademarks of their respective companies.

© 2018 APRO Corporation. All rights reserved