

W22IE3S-PTA3

21.5" Intel® Celeron® N6211 PT Series HMI Touch Panel PC



KEY FEATURES

- Low power consumption with Intel® Celeron® Elkhart Lake N6211 processor
- Fanless cooling system and ultra-low power consumption
- Front IP65 for protection against water and dust
- A true flat, easy-to-clean front surface with edge-to-edge design



SPECIFICATIONS

Display	
Resolution	1920x1080
Contrast Ratio	3000:1
View Angles	89,89,89,89
Touch / Glass	Projected Capacitive Multi Touch Screen
Size	21.5 inches
Panel Brightness	250.0 nits
Active Area	476.64x268.11 mm
System Specification	
WLAN	Support (Optional)
Processor	Intel® Celeron® N6211 (up to 3.0GHz) Intel® Celeron® N6210 (up to 2.6GHz) (Optional)
Storage	1 x M.2 2242 B-key SSD 128GB M.2 2242 B-key SSD up to 512GB (Optional) 1 x SATA III for 2.5" SSD/HDD up to 1TB (Optional)
Security	TPM 2.0
BT	Support (Optional)
Memory	1 x SO-DIMM, DDR4 3200 MHz, 4GB 8GB (Optional) 16GB (Optional)
Ethernet controller	2 x Intel® Ethernet Controller
Operating System	Windows 11 IoT Enterprise (64 bit) (Optional) Windows 11 Pro 64 bit (Optional) Windows 10 IoT Enterprise (64 bit) (Optional) Linux Ubuntu 22.04 (Optional)
Environment	
Operating Humidity	10% to 90% RH, Non-Condensing
Storage Temperature	-10°C to 60°C
Operating Temperature	0°C to 50°C
IP rating	Front IP65
Certification	
Certification	CE, FCC
Mechanical	
Dimension	530 x 322 x 56 mm
Enclosure	Plastic
Mounting	VESA Mount
Cooling System	Fanless Design
IO Ports	
USB Port	2 x USB3.2 Gen1x1 (Type-A)
Video	1 x HDMI 2.0 (Optional)
LAN	2 x RJ45-10/100/1000 Mbps
Serial Port	1 x RS232(Default)/422/485
Audio	2 x Speaker (Optional)
Indicator	Power LED Indicator
Power	

Power Rating 12V DC

Control

Button 1 x Power Button
1 x Reset Button

Accessory

Accessory Quick Start Guide(Hardcopy)
AC Adapter 12V/50W
Power Cord

DIMENSIONS UNIT:MM

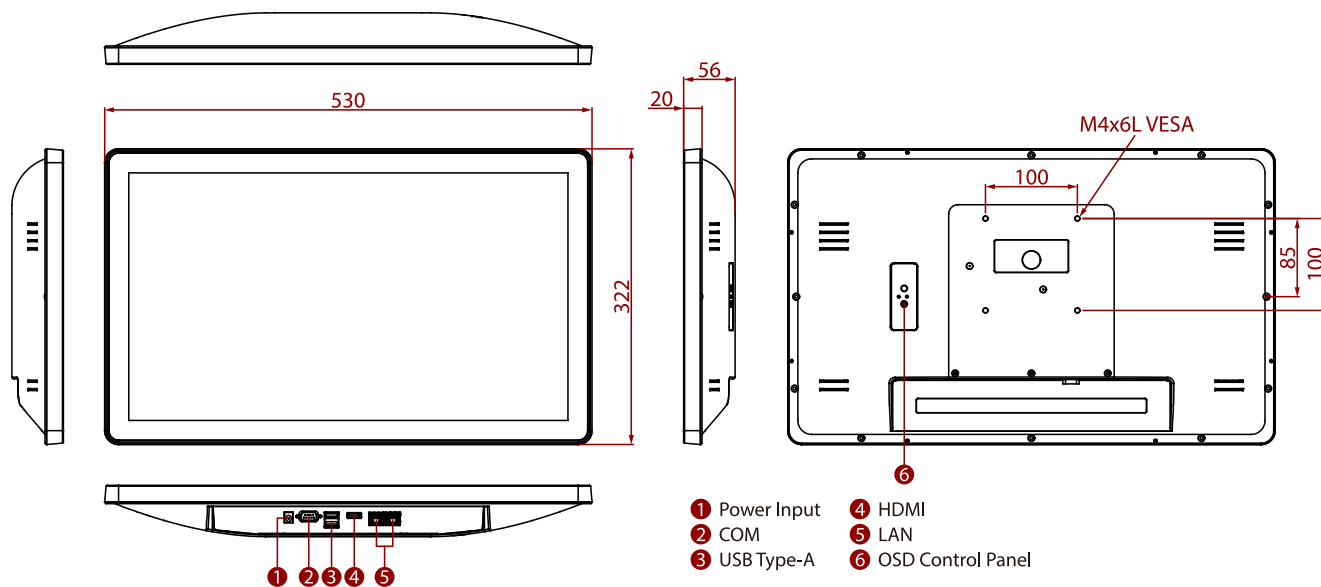

NOTE

- 1.This is a simplified drawing and some components are not marked in detail.
- 2.Please contact our sales representative if you need further product information.
- 3.All specifications are subject to change without prior notice.
- 4.The product shown in this datasheet is a standard model.For diagrams that contain customized or optional I/ O, please contact the Winmate Sales Team for more information.