

20836-253 PLUG-IN UNIT KIT FOR FMC WITH IEL HANDLE BLACK, U-SHAPED FRONT PANEL SHIELDED (TEXTILE), 3 U, 4 HP

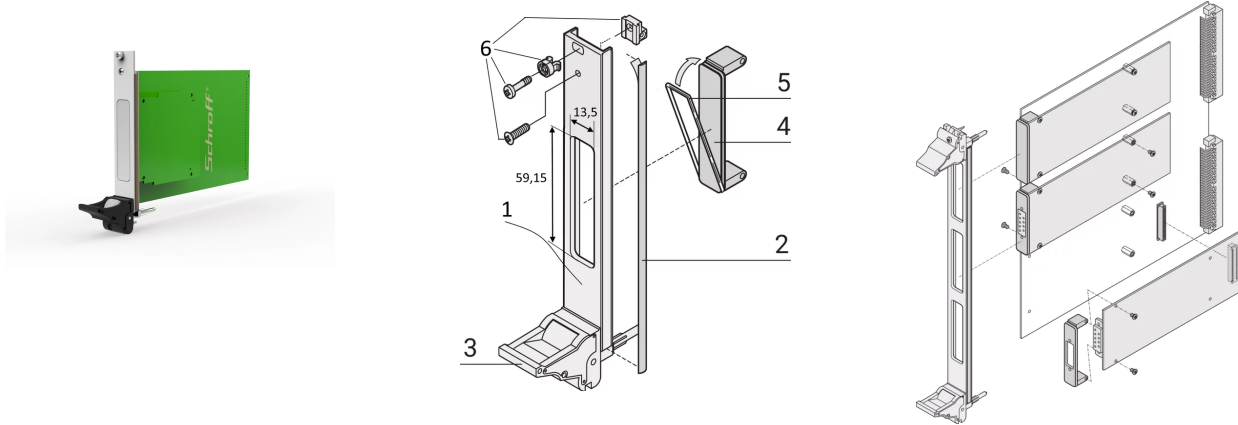

KEY FEATURES

In accordance with Vita 57.1 specification

For single 69.0 x 76.5 mm or double 139.0 x 76.5 mm modules

Al-Profile plug-in unit with IEL handle

PRODUCT ATTRIBUTES

Product Type: Front Panel

Type: Front Panel with Handle (PIU)

Handle Type: IEL

Mounting: Screw-on Front

EMC Shielding: Yes

EMC Gasket Type: Textile

Material: Aluminum

Front Finish: Anodized

Rear Finish: Conductive

Treated Edges: No

Rack Height: 3 U

Height: 128.4 mm

Rack Width: 4 HP

Width: 20 mm

Complies With: FMC Mezzanine, Vita 57.1

Package Quantity: 1

ADDITIONAL PRODUCT DETAILS

The FMC bezel are in accordance with Vita 57.1 specification. Covers the cut out in the overall front panel.

CERTIFICATIONS



North America

All locations
+1.763.422.2661
Chat with us:
schroff.nvent.com

Europe

Straubenhardt, Germany
+49.7082.794.0
Betschdorf, France
+33.3.88.90.64.90
Warsaw, Poland
+48.22.209.98.35
Assago, Italy
+39.02.932.7141
Chat with us:
schroff.nvent.com

Asia

Shanghai, China
+86.21.2412.6943
Qingdao, China
+86.532.8771.6101
Singapore
+65.6768.5800
Shin-Yokohama, Japan
+81.45.476.0271
Chat with us:
schroff.nvent.com

Middle East & India

Dubai, United Arab Emirates
+971.4.378.1700
Bangalore, India
+91.80.6715.2001
Istanbul, Turkey
+90.216.250.7374
Chat with us:
schroff.nvent.com



Our powerful portfolio of brands:
nVent.com **CADDY ERICO HOFFMAN RAYCHEM SCHROFF TRACER**

© 2023 nVent. All nVent marks and logos are owned or licensed by nVent Services GmbH or its affiliates. All other trademarks are the property of their respective owners.

nVent reserves the right to change specifications without notice.