

Features

- Single isolated GbE LAN port
- Complies with EN61000-4-5 2kV Surge protection
- Complies with IEC 60950-1:2005 + A1: 2009 + A2:2013 2kV HiPOT protection
- Complies with EN61000-4-2 (ESD) Air-15kV, Contact-8kV
- Flexible daughter board with cable to fit into different system
- Optional terminal mounting hole or bracket for daughter board
- Optional Industrial Temperature (-40°C to +85°C) support
- 30μ " golden finger, 3 years warranty
- Industrial design, manufactured in Innodisk Taiwan

Mechanical Drawing

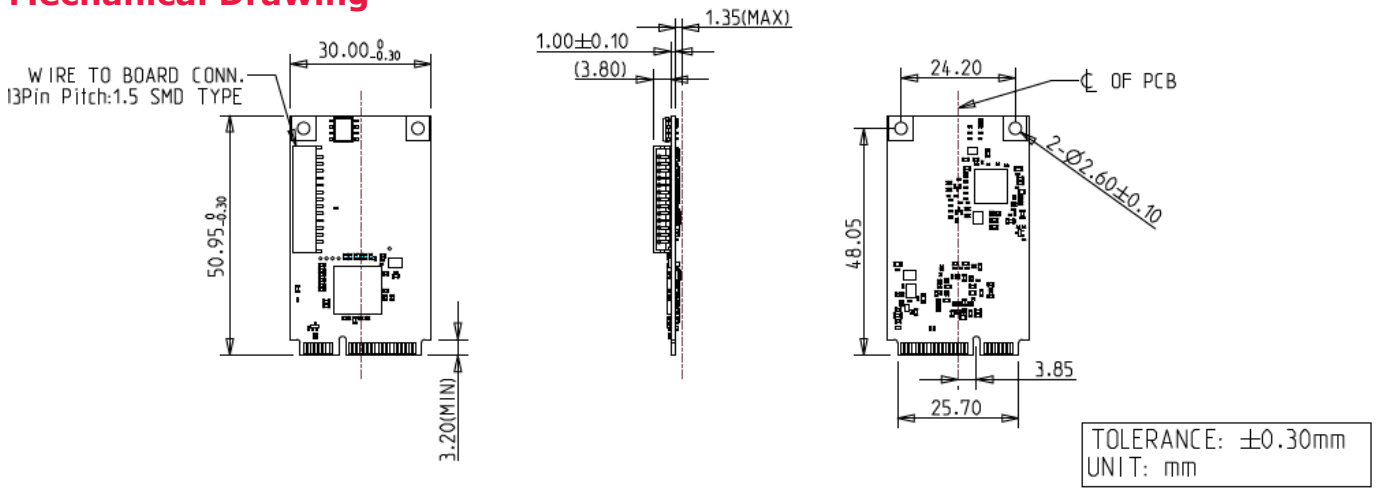

Specifications

| | |
|-------------------|--|
| Form-Factor | mPCIe |
| Input I/F | PCI Express 2.1 x 1 |
| Output I/F | Single GbE LAN |
| Output Connector | RJ45 x 1 |
| Power Consumption | MAX: 1.679W (3.3V, 509mA) |
| Dimension (WxLxH) | 30 x 50.95 x 6.15 mm |
| Temperature | Operation: STD: 0°C ~ +70°C. W/T: -40°C ~ +85°C Storage: -55°C ~ +95°C |
| Environment | Vibration: 5G @7~2000Hz, Shock: 50G @ 0.5ms |
| Notes | Please download driver from Intel official website. Windows: 10 (64bit), Linux (igc): kernel 5.x version |
| Limitations | *Linux kernel rebuild is needed (modify igc driver) if version < 5.15 *Not recommend used in VMware ESXi due to High Latency *Not support Intel vPro |

Headquarters (Taiwan)
5F., No.237, Sec. 1, Datong Rd.,
Xizhi Dist., New Taipei City 221,
Taiwan

Tel: +886-2-7703-3000
Email: sales@innodisk.com

Branch Offices:

USA
usasales@innodisk.com
+1-510-770-9421

Europe
eusales@innodisk.com
+31-40-3045-400

Japan
jpsales@innodisk.com
+81-3-6667-0161

China
sales_cn@innodisk.com
+86-755-2167-3689

www.innodisk.com

© 2022 Innodisk Corporation.
All right reserved. Specifications
are subject to change without
prior notice.

November 26, 2022

Order information

EMPL-G1S2-C1 (Mounting hole, Standard Temp.)

EMPL-G1S2-W1 (Mounting hole, Wide Temp.)

EMPL-G1S2-C2 (Bracket, Standard Temp.)

EMPL-G1S2-W2 (Bracket, Wide Temp.)

mPCIe to dual isolated GbE LAN horizontal module

EMPL-G1S2-C1/W1 Daughter Board and Mechanical Drawing

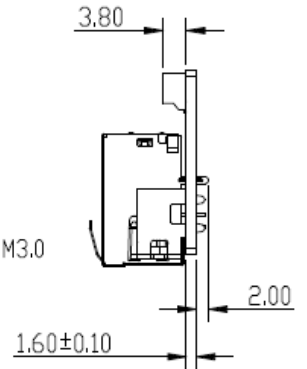
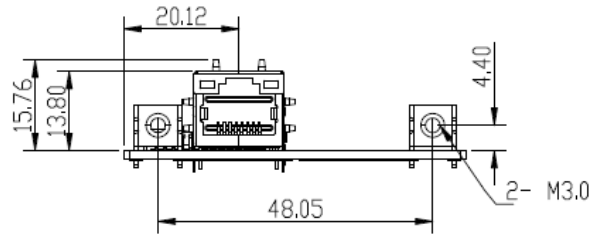
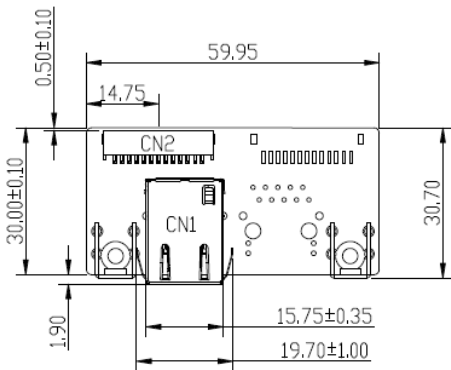
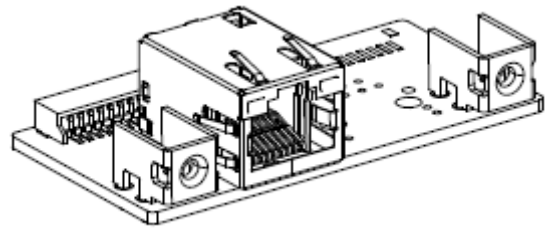
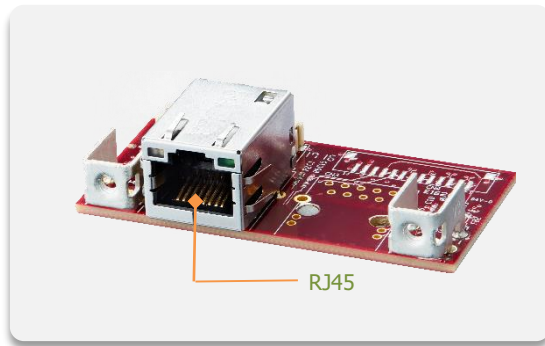

EMPL-G1S2-C2/W2 Daughter Board and Mechanical Drawing

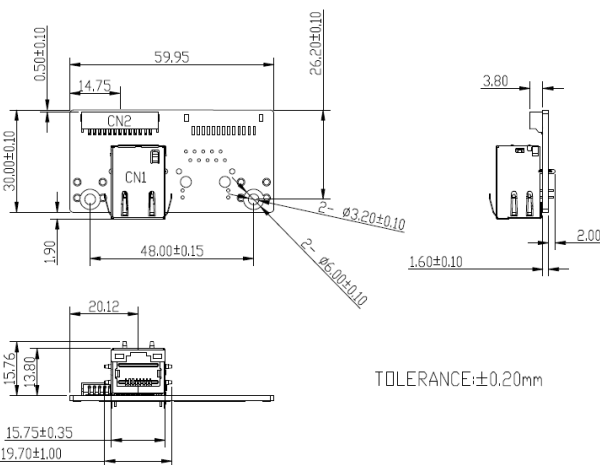
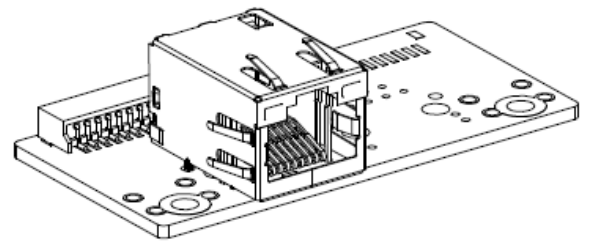
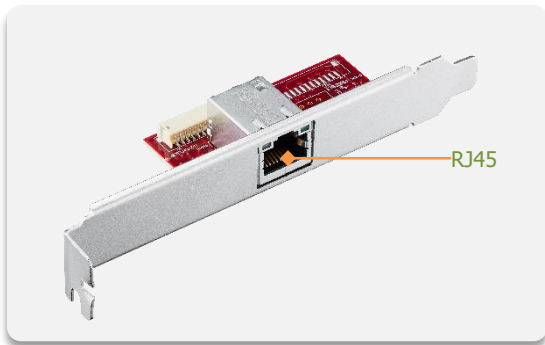

Bracket

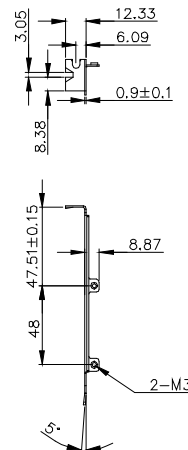
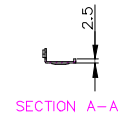
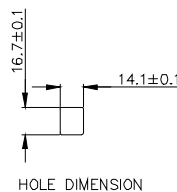

TOLERANCE: ±0.20mm

TOLERANCE: ±0.20mm