

23130-331 VARISTAR CABLE SUPPORT RAIL FOR CABINET DEPTH, RAL 7021, 1100D

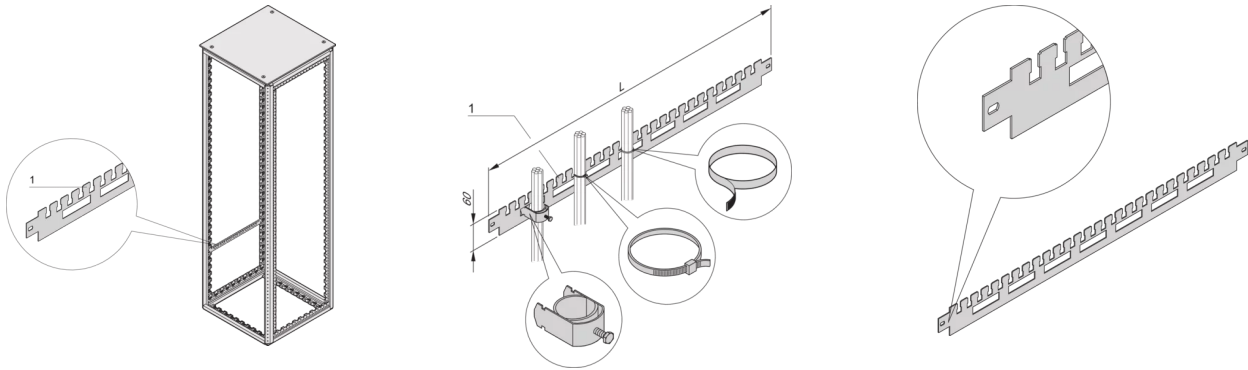

**KEY FEATURES**

For cable shells (bottom row) and for cable ties or Velcro (top row)

For cable ducting in side area of cabinet

**PRODUCT ATTRIBUTES**

Product Type: Support Rail

Product Family: Varistar

Type: Cable Support, Side Mount

Works With: Varistar CP

Material: Steel

Color: Black Grey

Color Code: RAL 7021

Depth: 1100 mm

Length: 966.4 mm

**ADDITIONAL PRODUCT DETAILS**

Varistar horizontal cable support rail in the cabinet depth. Mounted directly at the frame.



**North America**

All locations  
+1.763.422.2661  
Chat with us:  
[schroff.nvent.com](https://schroff.nvent.com)

**Europe**

Straubenhardt, Germany  
+49.7082.794.0  
Betschdorf, France  
+33.3.88.90.64.90  
Warsaw, Poland  
+48.22.209.98.35  
Assago, Italy  
+39.02.932.7141  
Chat with us:  
[schroff.nvent.com](https://schroff.nvent.com)

**Asia**

Shanghai, China  
+86.21.2412.6943  
Qingdao, China  
+86.532.8771.6101  
Singapore  
+65.6768.5800  
Shin-Yokohama, Japan  
+81.45.476.0271  
Chat with us:  
[schroff.nvent.com](https://schroff.nvent.com)

**Middle East & India**

Dubai, United Arab Emirates  
+971.4.378.1700  
Bangalore, India  
+91.80.6715.2001  
Istanbul, Turkey  
+90.216.250.7374  
Chat with us:  
[schroff.nvent.com](https://schroff.nvent.com)



Our powerful portfolio of brands:  
[nVent.com](https://nVent.com) **CADDY ERICO HOFFMAN RAYCHEM SCHROFF TRACER**