

23130-330 VARISTAR CABLE SUPPORT RAIL FOR CABINET DEPTH, RAL 7021, 1000D

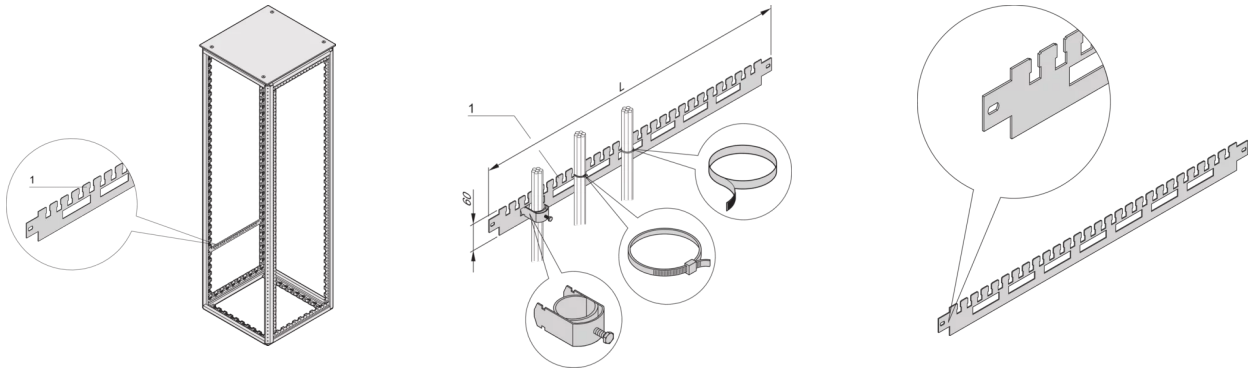

KEY FEATURES

For cable shells (bottom row) and for cable ties or Velcro (top row)

For cable ducting in side area of cabinet

PRODUCT ATTRIBUTES

Product Type: Support Rail

Product Family: Varistar

Type: Cable Support, Side Mount

Works With: Varistar CP

Material: Steel

Color: Black Grey

Color Code: RAL 7021

Depth: 1000 mm

Length: 866.4 mm

ADDITIONAL PRODUCT DETAILS

Varistar horizontal cable support rail in the cabinet depth. Mounted directly at the frame.



North America

All locations
+1.763.422.2661
Chat with us:
schroff.nvent.com

Europe

Straubenhardt, Germany
+49.7082.794.0
Betschdorf, France
+33.3.88.90.64.90
Warsaw, Poland
+48.22.209.98.35
Assago, Italy
+39.02.932.7141
Chat with us:
schroff.nvent.com

Asia

Shanghai, China
+86.21.2412.6943
Qingdao, China
+86.532.8771.6101
Singapore
+65.6768.5800
Shin-Yokohama, Japan
+81.45.476.0271
Chat with us:
schroff.nvent.com

Middle East & India

Dubai, United Arab Emirates
+971.4.378.1700
Bangalore, India
+91.80.6715.2001
Istanbul, Turkey
+90.216.250.7374
Chat with us:
schroff.nvent.com



Our powerful portfolio of brands:
nVent.com **CADDY ERICO HOFFMAN RAYCHEM SCHROFF TRACER**