

22114-458 EURORACK C-RAIL FOR CABINET 900D

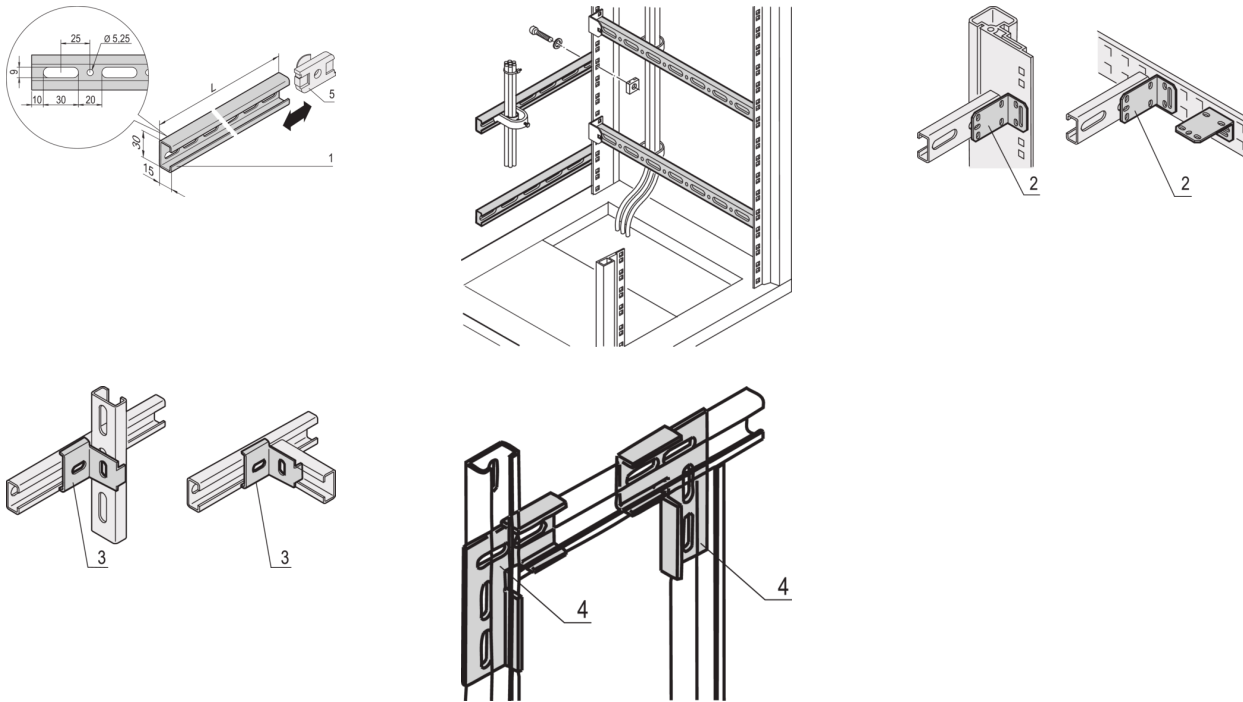

KEY FEATURES

The mounting system provides for fitting of horizontal and vertical mounting planes

By using slide nuts, C-profiles may be adjusted continuously

Cable shells can be placed directly into the C-profiles.

PRODUCT ATTRIBUTES

Product Type: C-Rail

Product Family: Eurorack

Depth: 900 mm

ADDITIONAL PRODUCT DETAILS

C-Rails are for better cable management. Installation generally behind the 19" uprights. They are compatible with standard cable clabs.

Please order brackets for assembly separately.

CERTIFICATIONS



North America

All locations
+1.763.422.2661
Chat with us:
schroff.nvent.com

Europe

Straubenhardt, Germany
+49.7082.794.0
Betschdorf, France
+33.3.88.90.64.90
Warsaw, Poland
+48.22.209.98.35
Assago, Italy
+39.02.932.7141
Chat with us:
schroff.nvent.com

Asia

Shanghai, China
+86.21.2412.6943
Qingdao, China
+86.532.8771.6101
Singapore
+65.6768.5800
Shin-Yokohama, Japan
+81.45.476.0271
Chat with us:
schroff.nvent.com

Middle East & India

Dubai, United Arab Emirates
+971.4.378.1700
Bangalore, India
+91.80.6715.2001
Istanbul, Turkey
+90.216.250.7374
Chat with us:
schroff.nvent.com



Our powerful portfolio of brands:
nVent.com **CADDY ERICO HOFFMAN RAYCHEM SCHROFF TRACER**

© 2023 nVent. All nVent marks and logos are owned or licensed by nVent Services GmbH or its affiliates. All other trademarks are the property of their respective owners.

nVent reserves the right to change specifications without notice.