nVent SCHROFF Cooling Cabinet LHX+

User Manual

Release 1.0
07.04.2021



Doc-No.: 61130-210

Schroff GmbH
Langenalber Str. 96-100
75334 Straubenhardt/Germany
schroff.nVent.com

This document is furnished under license and may be used or copied only in accordance with the terms of such license. The content of this manual is furnished for informational use only, is subject to change without notice, and should not be construed as a commitment by nVent. nVent assumes no responsibility or liability for any errors or inaccuracies that may appear in this document.

Except as permitted by such license, no part of this publication may be reproduced, stored in a retrieval system, or transmitted, in any form or by any means, electronic, manual, recording, or otherwise, without the prior written permission of nVent.

All nVent marks and logos are owned or licensed by nVent Services GmbH or its affiliates. All other trademarks are the property of their respective owners. nVent reserves the right to change specifications without notice.

Copyright © 2021 nVent

All Rights Reserved.

1 Safety	5
1.1 Intended Use.....	5
1.2 Safety instructions of the manufacturer	5
1.2.1 Disclaimer.....	5
1.3 Safety symbols used in this manual	6
1.4 Safety Information for the Operator	7
1.4.1 General notes	7
1.4.2 Qualification of the personnel	7
1.4.3 Personal protective equipment	7
1.5 Safety features	7
2 LHX+ overview	8
2.1 Functional description	10
2.2 Cooling capacity control	11
3 Transport and assembly	12
3.1 Safety rules for transport and assembly	12
3.2 Unpacking.....	13
3.3 Placing the cabinet.....	14
3.3.1 Lifting the cabinet from the pallet	15
3.4 Commissioning.....	16
3.4.1 Connection to the cooling water supply.....	17
3.4.2 Requirements for the water quality	18
3.4.3 Water connection.....	19
3.5 Bleeding the cooling module	20
3.5.1 Mains connection.....	21
3.5.2 Mains inputs	22
3.6 Connectors controller box	23
3.6.1 Plug in/Unplug connectors at the controller box.....	23
3.7 Initial operation.....	24
4 Monitoring and Configuration	25
4.1 Web Interface.....	25
4.1.1 Web interface screens	25

4.2	Display	29
4.2.1	Display Overview	30
4.2.2	Display menu	31
4.2.3	Settings	32
5	Maintenance	34
5.1	Fan tray replacement	34
6	Optional water kit.....	35
6.1	Installing the water kit.....	36
7	Dismantling, storage and disposal	37
7.1	Safety rules for dismantling, storage and disposal.....	37
7.2	Dismantling	38
7.3	Storage	38
7.4	Disposal	38
8	Technical data.....	39
8.1	Scope of delivery.....	40
8.2	Spare parts	42
8.3	Accessoires.....	43
8.4	Cooling performance	45
8.5	Air flow	46
8.7	Noise Level	47

1 Safety

1.1 Intended Use

The nVent SCHROFF LHX+ cabinets described in this manual represent closed cooling systems and allow cooling of the electronic components installed in the 19" plane independently of the ambient or room temperature.

Before commencing operation the cabinet's cooling modules must be connected to an external recirculation cooling system (chiller).

Intended use includes compliance with the terms and conditions for assembly, disassembly, commissioning, operation and maintenance specified by the manufacturer.

1.2 Safety instructions of the manufacturer

1.2.1 Disclaimer

Schroff accepts no liability for any errors in this documentation. To the maximum extent permissible by law, any liability for damage, direct or indirect, arising from the supply or use of this documentation is excluded.

Schroff retains the right to modify this document, including the liability disclaimer, at any time without notice and accepts no liability for any consequences of such alterations.

1.3 Safety symbols used in this manual

In these original operating instructions, warning notices point out residual risks that cannot be avoided by constructive means when installing or operating the cooling module. The warning notices are classified according to the severity of the damage occurring and the probability of its occurrence.

⚠ DANGER	
Symbol	Short description of the danger The signal word DANGER indicates an immediate danger. Non-observance will result in severe injuries or death.

⚠ WARNING	
Symbol	Short description of the danger The signal word WARNING indicates a possible danger. Non-observance can lead to serious injury or death.

⚠ CAUTION	
Symbol	Short description of the danger The signal word CAUTION indicates a possible danger. Non-observance can lead to injuries.

ATTENTION	
Short description The signal word ATTENTION indicates possible damages to equipment. Non-observance can lead to damage to the device.	

	Important information
---	------------------------------

1.4 Safety Information for the Operator

1.4.1 General notes

The operator must comply with all relevant safety regulations for setting up and operating the nVent SCHROFF LHX+ cabinets, e.g. accident prevention regulations for the operation of cooling equipment. Furthermore, the installation and connection conditions and the corresponding instructions in Chapter 3 Transport and installation must be observed.

1.4.2 Qualification of the personnel

Only trained specialists are authorized to carry out assembly, commissioning, completion, maintenance and service of the LHX+ cabinets or the integrated cooling modules. The nationally applicable health and safety regulations must also be adhered to.

1.4.3 Personal protective equipment

⚠ WARNING	
	<p>Risk of injury due to insufficient personal protective equipment</p> <p>If you use the wrong protective equipment or no protective equipment at all, you could be seriously injured.</p> <ul style="list-style-type: none"> - Wear protective equipment adapted to the work processes. - Check the protective equipment before each use to ensure that it is intact! - Use only approved protective equipment.

The personnel responsible for installation, maintenance and operation must wear protective equipment appropriate to the work processes.

The following personal protective equipment is required:

- Safety glasses
- Helmet
- Protective gloves
- Protective boots

1.5 Safety features

The cabinet is equipped with door contact switches (1, 2) to protect the operator and the equipment from spraying water. When the doors are open, the cooling module is shut off, the fans are disabled.

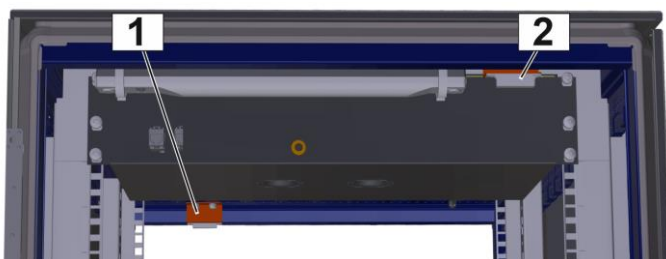

2 LHX+ overview

The nVent SCHROFF LHX+ product family are closed electronics cabinets with integrated air-to-water heat exchangers installed at the bottom of the 19" plane.

The following variants are available at the time of the compilation of this manual:

Part-No.	Type	Height/Width/Depth	Rear door	Display	Gasket
10130-325	LHX+ 5 kW	2000 x 600 x 800 mm	-	-	IP
10130-326	LHX+ 5 kW	2000 x 600 x 1000 mm	x	x	EMC
10130-327	LHX+ 10 kW	2000 x 600 x 1000 mm	-	x	EMC



1	Controller box	5	Warm air temperature sensor top
2	Cold air temperature sensor top	6	Warm air temperature sensor bottom
3	Cold air temperature sensor bottom	7	Cooling module
4	Door contact	8	Display

Cooling module 5 kW

Cooling module 10 kW

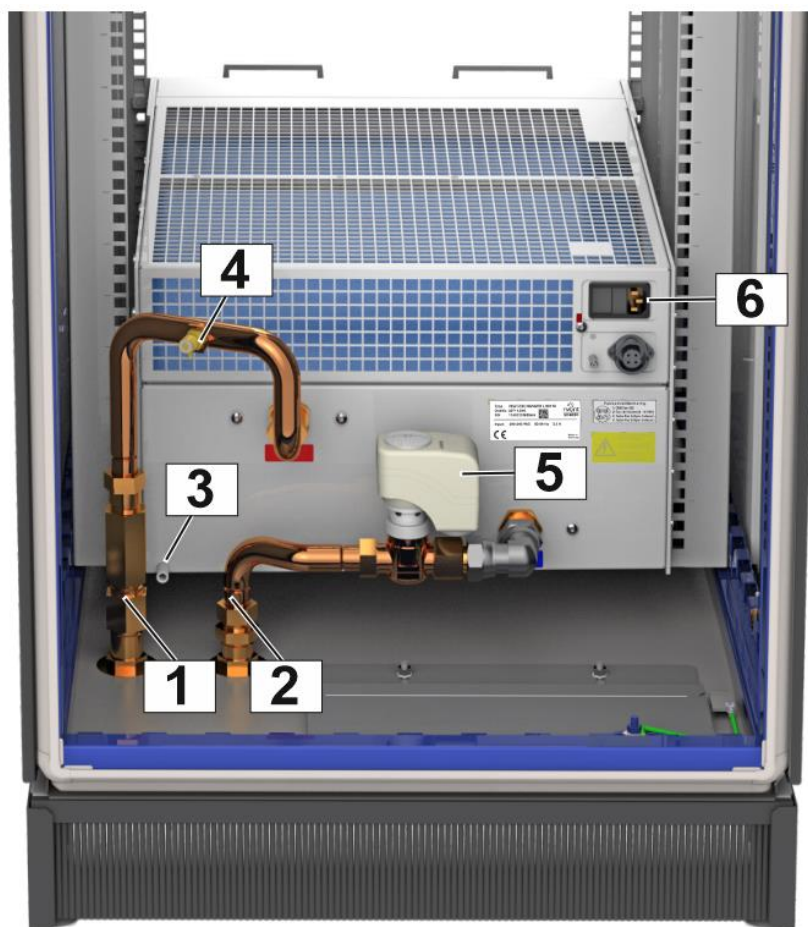

1 Water outlet	4 Bleeding valve
2 Water inlet	5 Actuator water valve
3 Condensate drain (10 mm)	6 Fused mains input IEC60320-C14

	<p>The cooling modules contain no user serviceable parts inside; the fan trays are hot swappable.</p>
---	---

2.1 Functional description

The cooling system consists of an air loop and a water loop.

The fans of the cooling unit draw warm air from the rear section of the cabinet and into an air/water heat exchanger. The air is cooled down and then blown into the front area of the cabinet.

Inside the air/water heat exchanger the heat energy of the warm air is transferred to the medium of water. The air/water heat exchanger is connected to an external reciprocal chiller unit (not supplied with the module), where the water is cooled down again.

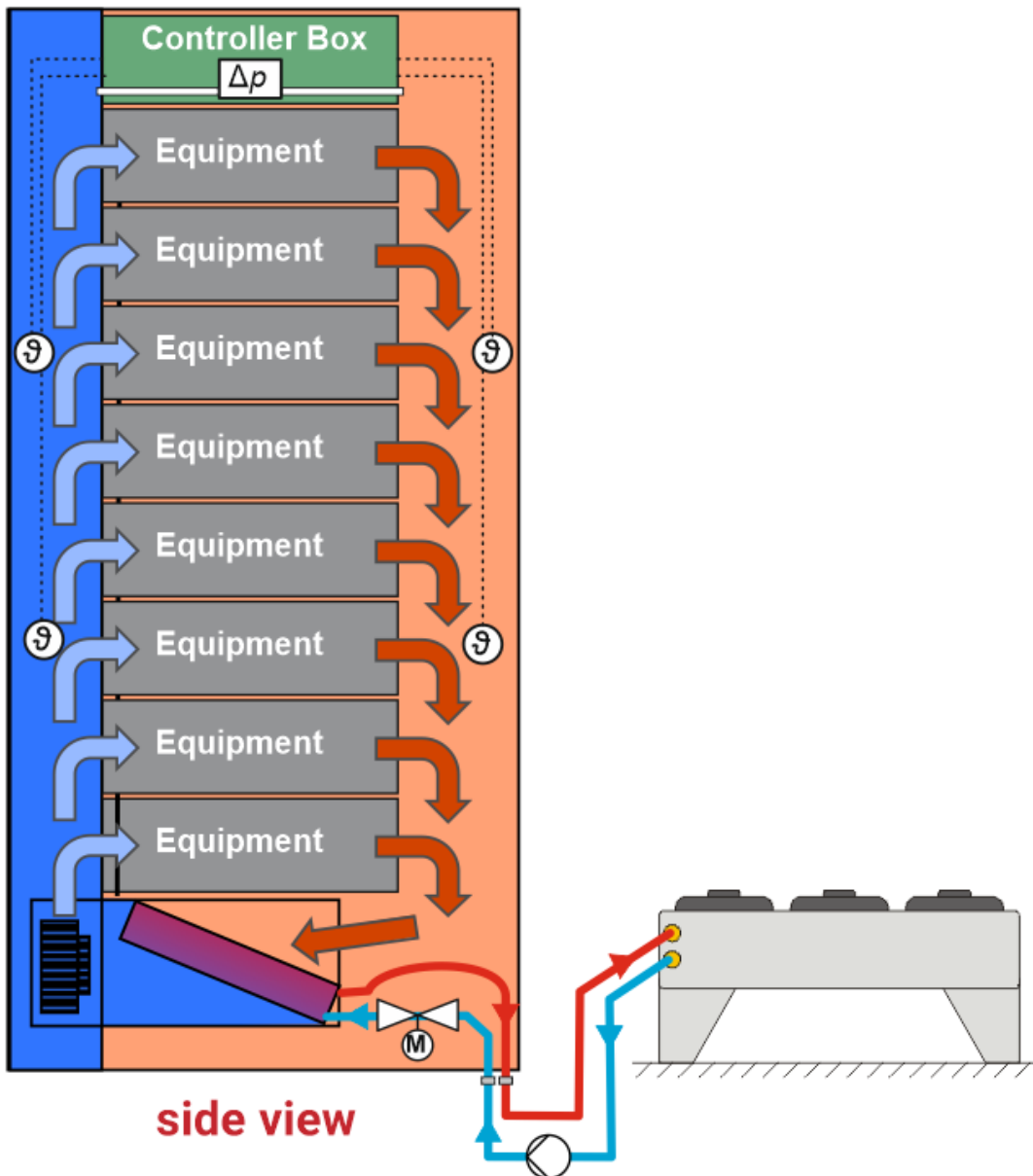

The water inlet temperature and the cooling water flow and the air flow determine the cooling capacity of the cooling module.

2.2 Cooling capacity control

Controller Box

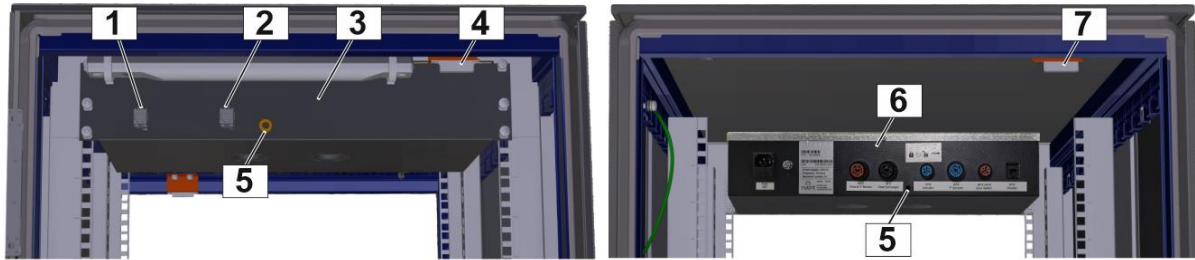

1	RJ45 connector Ethernet	5	Air inlet for differential pressure sensor
2	RJ45 connector RS485 (Modbus RTU)	6	Controller box rear view
3	Controller box front view	7	Door contact rear door/rear panel
4	Door contact front door		

The LHX+ controller is located together with the differential pressure sensor in a 2 U / 19" controller box (6) at the top of the cabinet.

The controller drives an electromechanical control valve in the water circuit to regulate the flow of water through the heat exchanger as a function of the heat load. The control variable is the data from the cold air temperature sensors.

In order to compensate for temperature stratification, the cold air temperature is measured by 2 temperature sensors at different heights. As control variable the temperature of the lower, the upper or the average value of these temperature sensors can be used as a reference. The air flow rate also has an influence on the cooling capacity, the controller can either set the fan speed to a fixed value of 70 % -100 % or adjust it depending on the differential pressure.

3 Transport and assembly

3.1 Safety rules for transport and assembly

⚠ WARNING	
	<p>Risk of injury and/or material damage from falling or tipping loads!</p> <ul style="list-style-type: none"> • When transporting the cabinet with a pallet truck, forklift or crane, do not step under the suspended load. • Only use approved equipment and slings to lift the cabinet. • During transport and assembly, the corresponding personal protective equipment must be worn. • The cabinet is top-heavy and can tip over. At least 2 people are required when moving and unpacking the cabinet

⚠ WARNING	
	<p>Risk of accidents due to insufficiently qualified personnel!</p> <ul style="list-style-type: none"> • The installation may only be carried out by qualified personnel who are authorized to do so according to the valid safety regulations, e.g. by authorized specialized companies or authorized departments of the company. • When installing the system, the corresponding personal protective equipment must be worn.



Use eye protection!



Use hand protection!



Use foot protection!



Use head protection!

The specified personal protective equipment must be used during all assembly and transport work.

ATTENTION
<p>Risk of condensation forming!</p> <p>After storage at temperatures below 10 °C, sufficient acclimatization time must be allowed before the unit is switched on.</p>

3.2 Unpacking

The LHX+ is delivered on a pallet.

- Remove any transport material and packaging.
- Dispose of the transport and packaging material in an environmentally compliant manner and in accordance with the applicable local rules and regulations.
- Leave the cabinet on the pallet to transport it to its destination.



Check the LHX+ after unpacking for transport damage or other damage.

3.3 Placing the cabinet

⚠ WARNING	
	<p>Risk of injury and/or material damage from falling or tipping loads!</p> <ul style="list-style-type: none"> • When transporting the cabinet with a pallet truck, forklift or crane, do not step under the suspended load. • Only use approved equipment and slings to lift the cabinet. • During transport and assembly, the corresponding personal protective equipment must be worn. • The cabinet is top-heavy and can tip over. At least 2 people are required when moving and unpacking the cabinet

ATTENTION	
<p>Risk of damage!</p> <p>The cabinet must only be mounted on a flat surface with sufficient load-bearing capacity. Remove the transport protection for the water connections only after lifting the cabinet from the pallet.</p>	

	<p>It is recommended to use lifting eyes and a crane to lift the cabinet from the pallet.</p>
--	---

3.3.1 Lifting the cabinet from the pallet

The following steps describe how to lift the cabinet from the pallet with a forklift truck.

1) Transport the cabinet on the pallet to the installation site and remove the fastening screws with which the cabinet is fixed on the pallet.

Note: For 800 mm deep cabinets, the fan trays must be removed first.

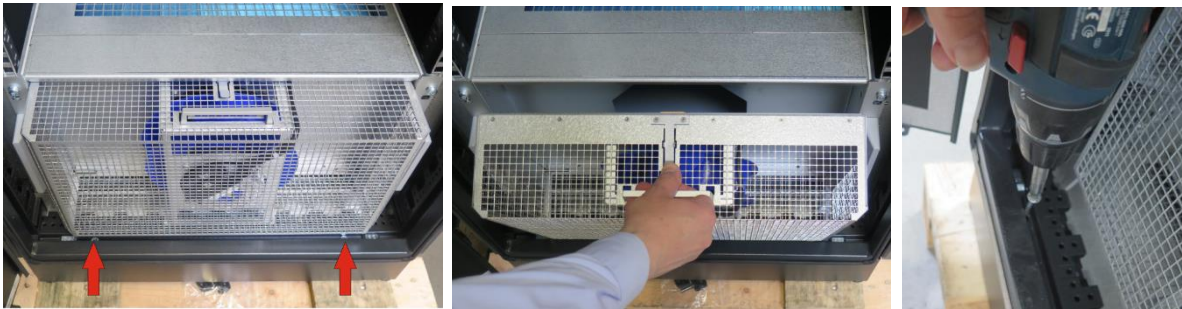

2) Remove the frontpanels and sidepanels.



3) Adjust the forks to the cabinet width.



4) Lift the cabinet carefully from the pallet without damaging the leveling feet (1) and the transport protection (2). Leave enough space (3) between the cabinet and the forklift

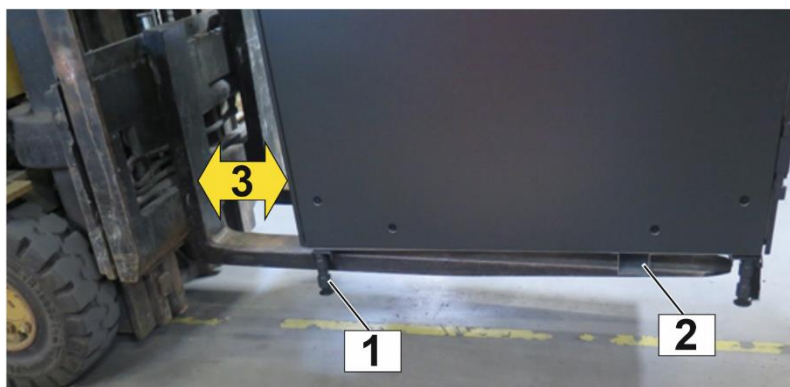

5) Level the cabinet at the installation site using the leveling feet (1).

6) Remove the transport protection (2) for the water connections.

3.4 Commissioning

The cabinet is completely wired and preconfigured. After connecting the power and water supply, it can be put into operation.

ATTENTION

Damage due to leaking water!

Fittings may have loosened due to transport or during installation.

Before commissioning, all fittings of the water circuit must be checked and tightened if necessary.

The leaktightness must be checked during filling of the system.

ATTENTION

Damage due to condensation and spraying water!

The cabinet doors must be closed for operation. If the cooling module is operated in an open cabinet, condensation water will be produced around the heat exchanger, which is distributed by the fans in the enclosure and can damage the electronics components.



The cabinet is equipped with door contact switches. When the doors are open, the cooling module is shut off, the fans are disabled.
To ensure proper function and cooling performance, the front 19" plane must be sealed off from the rear part of the cabinet by suitable air baffle plates and seals.

3.4.1 Connection to the cooling water supply

ATTENTION

Outflow of cooling water can cause damage!

- Connection to the cooling water supply should be carried out by a refrigeration engineer or suitably trained plumber.

- It must be ensured that suitable structural measures (leak sensor, automatic shut-off valves) prevent damage to surrounding components in the event of a leak or defect. These measures depend on the installation location or the structural conditions and are the responsibility of the installer or system designer.

- Ensure that the water supply pressure does not exceed the unit rating.

	<p>Notes on the water connection:</p> <ul style="list-style-type: none"> • The cooling infrastructure to which the unit is connected (the external water loop) must be appropriately dimensioned by the system designer, taking into consideration the available pump pressure and type, the nominal pipe diameters and the pressure loss expected in the load circuit (the cooling module). • To avoid a pressure drop in the system, the water pipes should be kept as short as possible. • The behavior of the materials used in the cooling module with the materials of the external water circuit must be observed in order to avoid corrosion damage! • When creating the on-site piping, contamination in the line system must be avoided, or the lines must be flushed before connecting the cooling module. • Shut-off and drain valves on each cabinet as well as a central water filter and air separator are mandatory.
---	--

3.4.2 Requirements for the water quality

ATTENTION

Risk of corrosion!

- If aluminum is used in the external water circuit, there is a risk of corrosion.
- To avoid electrochemical corrosion, the compatibility of the materials used in the cooling module with those of the external cooling circuit must be observed.
- The type and dosage of a suitable anticorrosive or antifreeze agent depends on the structural environment and the external recooling system and must be determined individually by the plant planner.



The following materials are used in the cooling module:

- Aluminum
- Brass
- Copper
- Stainless steel

To ensure trouble-free operation of the cooling module, the following water quality requirements must be met.

(see also VDI 3803 / ASHRAE: Liquid cooling guidelines for Datacom equipment centers, second edition).

Electrical conductivity:	25 mS/m - 100 mS/m at 25 °C /77 °F
Hydrogen concentration:	7,5 - 8,5 (ph-value) at 20 °C /68 °F
Chloride:	< 50 mg/l / 50 ppm
Total Hardness:	> 3 °dH < 8 °dH
Colony-forming units:	< 1000 CFU/ml
Appearance:	clear
Colour:	colourless

3.4.3 Water connection

Cabinet bottom view



The water return (3) and supply (4) connections are located under the bottom plate of the cabinet. During transport, the water connections are protected by an angled sheet metal (2). To remove the sheet metal and access the water connections you have to remove the lower side panels (1).



The required connection nominal widths and the position of the connections at the cabinet's bottom plate can be found in the drawings in the appendix to this manual.

Condensate drain:

The bottom of the cooling module is designed as a condensate tray with a 10 mm hose connection (5) at the rear side. By default, the hose connection is closed by a plug. Especially at low water inlet temperatures it is recommended to realize the condensate drain on site via the hose connection (5).

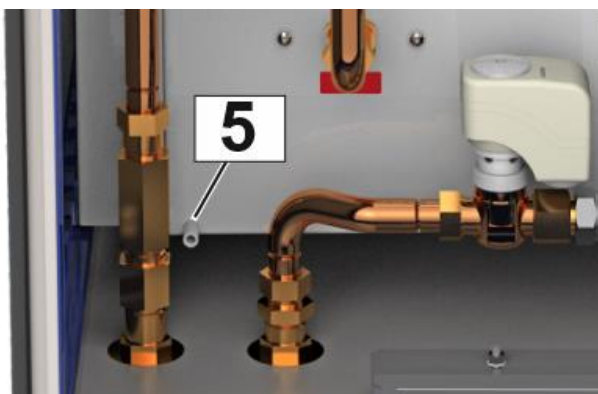

Connect the water supply, water return and condensate drain according to the drawings in the appendix to this operating manual.

3.5 Bleeding the cooling module

ATTENTION

Risk of damage!

To avoid damage, the cooling module must be disconnected from the power supply during bleeding.

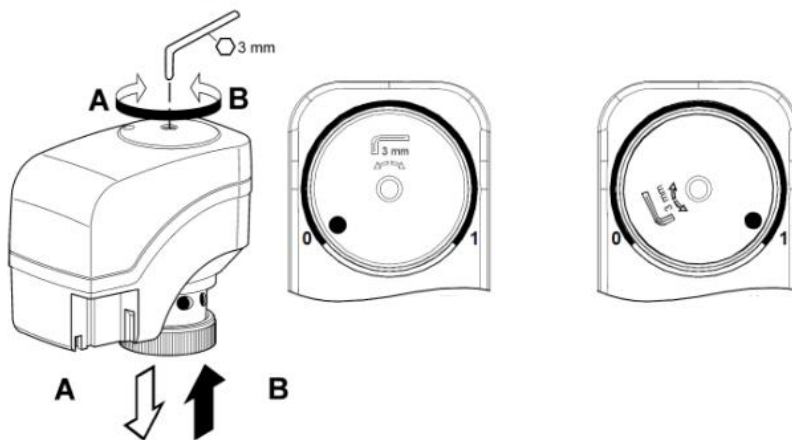
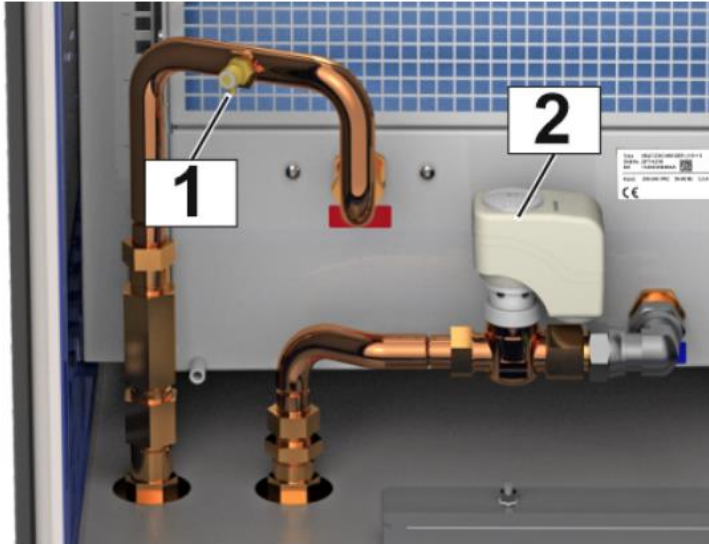

Before commissioning, the device must be bled.

- Have the refrigeration engineer/plumber open the water flow to the cabinet.
- Connect a tube to the bleeding valve (1) and place it in a container with a capacity of at least 1.5 litres.
- Open the actuator (2) manually with a 3 mm hexagonal key. (Turn it to position “1”)
- Close the return valve and open the supply valve (Stopcocks in the raised floor)
- Open the bleeding valve (1) carefully using a four-sided Allen key.
- Allow any air to escape. When water begins to pass, close the bleeding valve.

⚠ WARNING



Power cable rating

If the was not supplied with AC power cables, purchase AC power cables approved for use in your country. The AC power cables must be rated for the product and for the voltage and current marked on the product's electrical ratings label. The voltage and current rating of the cable should be greater than the ratings marked on the product.



The cooling module must be operated with protective earth/GND connection. Use only a three conductor AC power cable with a protective earth conductor that meets the IEC safety standards!

ATTENTION

Incorrect mains voltage can lead to component damage!

Verify that your mains voltage corresponds with the product's electrical ratings label.

Electrical rating cooling module (Example)

Type:	Heat Exchanger LHX 10 kW	 
Ord.No:	29714-016	
S/N:	13453335688AA	
Input:	200-240 VAC 50-60 Hz 3,3 A	
		schroff.nvent.com Made in Germany

3.5.2 Mains inputs

The cabinet has two IEC60320-C14 AC power inputs. One AC power input is located on the controller box at the top of the cabinet, the other at the bottom at the cooling module.

To put the device into operation, both inputs must be powered.

Power input cooling module

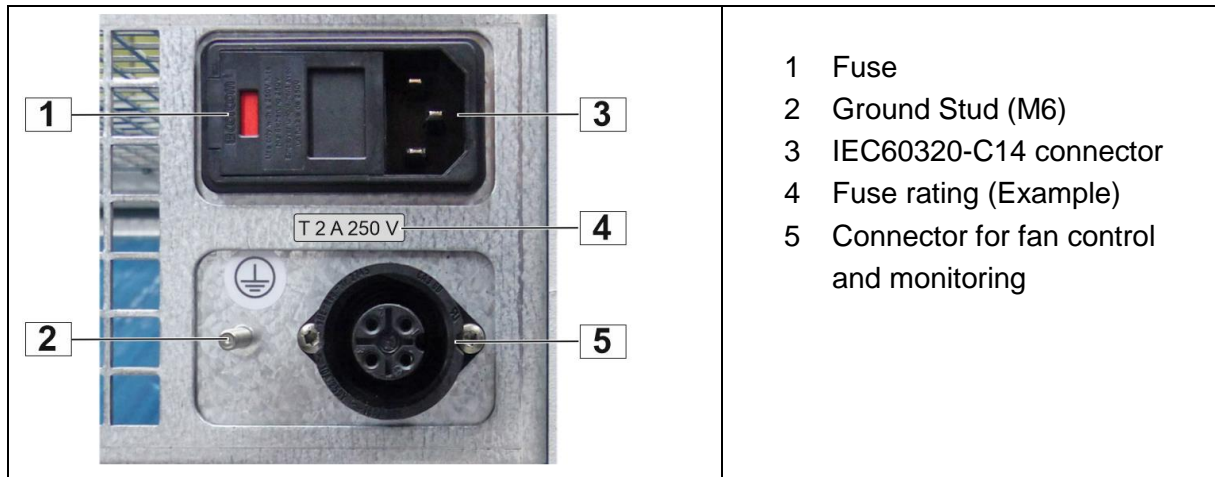

Power input controller box

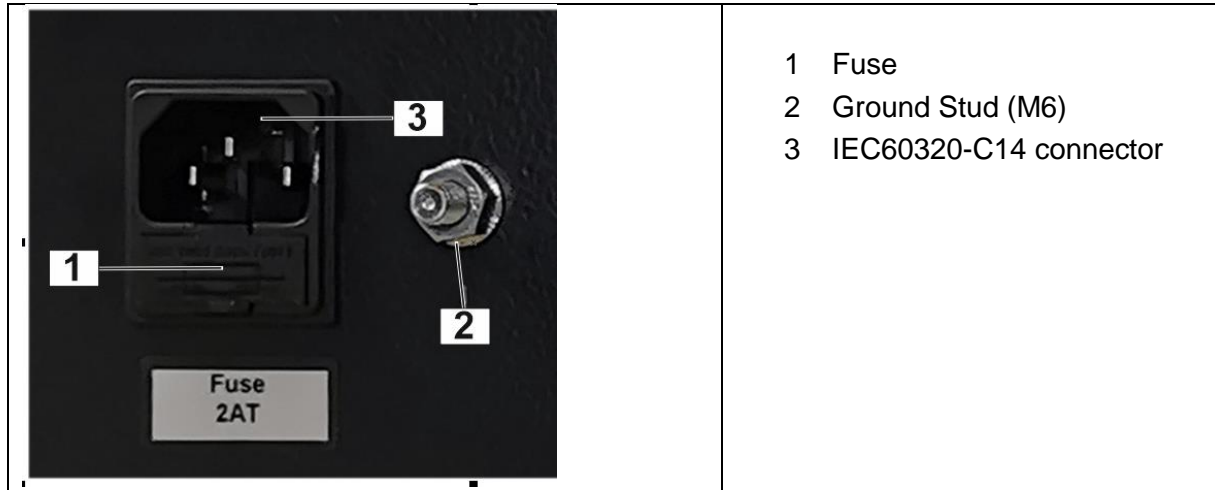

3.6 Connectors controller box

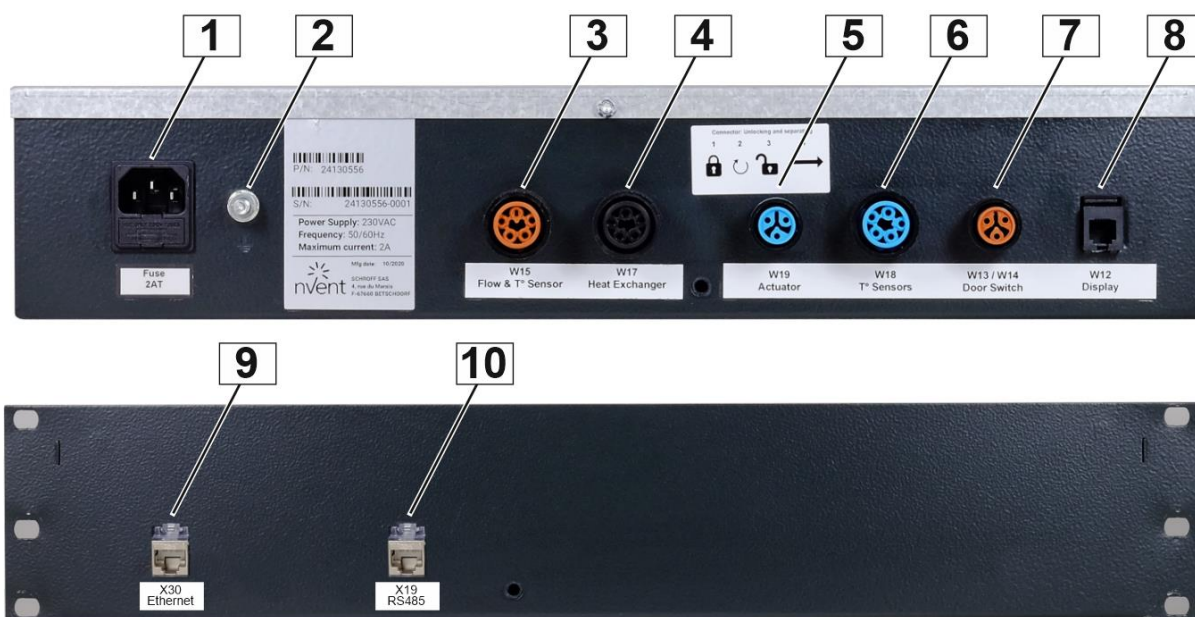

1	IEC60320-C14 connector	6	Connector for temperature sensors
2	Ground Stud (M6)	7	Connector for door contacts
3	Connector for optional flow and temperature sensor	8	Connector for remote display
4	Connector for cooling module fan control	9	RJ45 connector Ethernet
5	Connector for valve actuator	10	RJ45 connector RS485 (Modbus RTU)

3.6.1 Plug in/Unplug connectors at the controller box

The plugs are protected against disconnection by a locking mechanism. To remove the plugs, the locking ring must be turned to the right.

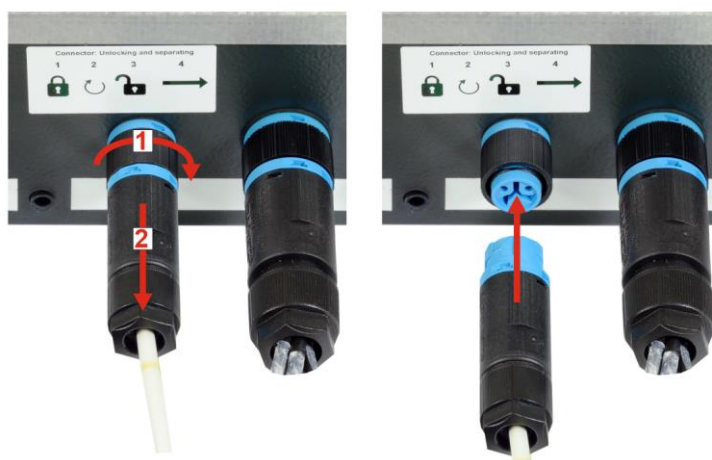

3.7 Initial operation

	<p>The cabinet is equipped with door contact switches. When the doors are open, the fans are disabled and the control valve is closed.</p> <p>To ensure proper function and cooling performance, the front 19" plane must be sealed off from the rear part of the cabinet by suitable air baffle plates and seals.</p>
---	--

- Make sure that power and water supply are connected and the doors are closed.
- The cooling in the cabinet starts with the default settings.

	<p>Default settings:</p> <ul style="list-style-type: none"> • Cold air temperature: 24 °C • Temperature sensor: Average outlet temperature • Fan speed: 70 % manual control
---	---

The default settings can be changed via the remote display or after log-in to the web interface of the controller.

4 Monitoring and Configuration

The LHX+ can be configured or the operating parameters can be monitored using a web interface or via the remote display.

It is also possible to configure and monitor the operating parameters via Modbus TCP (IP) or Modbus RTU (RS485).

For this purpose the LHX controller can be connected to the nVent Schroff Guardian Management Gateway which natively supports the control of the LHX+ cooling module.

A list of Modbus registers is available on request.

Alternatively, control and monitoring via SNMP or BACnet is also available as an option.

4.1 Web Interface

- Access to the web interface: 192.168.0.101
- User: siteadmin
- PW: 12345

4.1.1 Web interface screens

Screen System: Overview of the system parameters

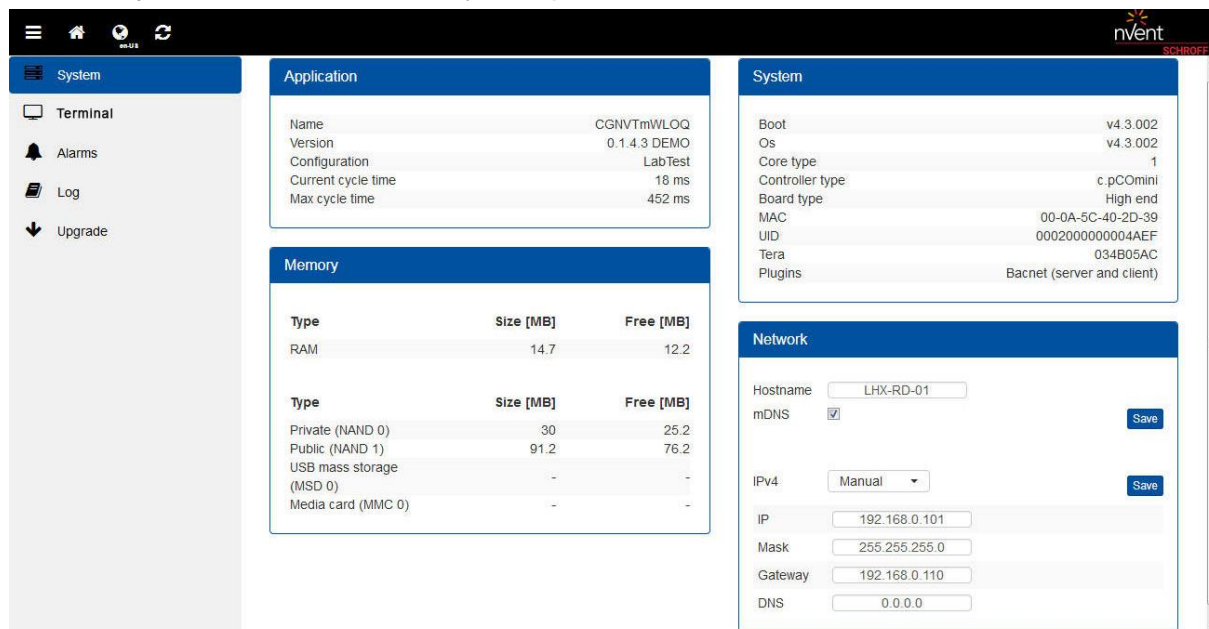

The screenshot displays the nVent web interface for system configuration. It features a sidebar with navigation options: System, Terminal, Alarms, Log, and Upgrade. The main content area is divided into several panels:

- Application:**

Name	CGNVTmWLOQ
Version	0.1.4.3 DEMO
Configuration	LabTest
Current cycle time	18 ms
Max cycle time	452 ms
- Memory:**

Type	Size [MB]	Free [MB]
RAM	14.7	12.2
Type	Size [MB]	Free [MB]
Private (NAND 0)	30	25.2
Public (NAND 1)	91.2	76.2
USB mass storage (MSD 0)	-	-
Media card (MMC 0)	-	-
- System:**

Boot	v4.3.002
Os	v4.3.002
Core type	1
Controller type	c.pCOMini
Board type	High end
MAC	00-0A-5C-40-2D-39
UID	0002000000004AEF
Tera	034B05AC
Plugins	Bacnet (server and client)
- Network:**

Hostname: LHX-RD-01

mDNS: Save

IPv4: Manual Save

IP: 192.168.0.101

Mask: 255.255.255.0

Gateway: 192.168.0.110

DNS: 0.0.0.0

Screen Terminal: Emulates the remote display.

In this screen, all sensor data and operating parameters can be displayed and parameterized. A description of the functions can be found in the chapter "Display".

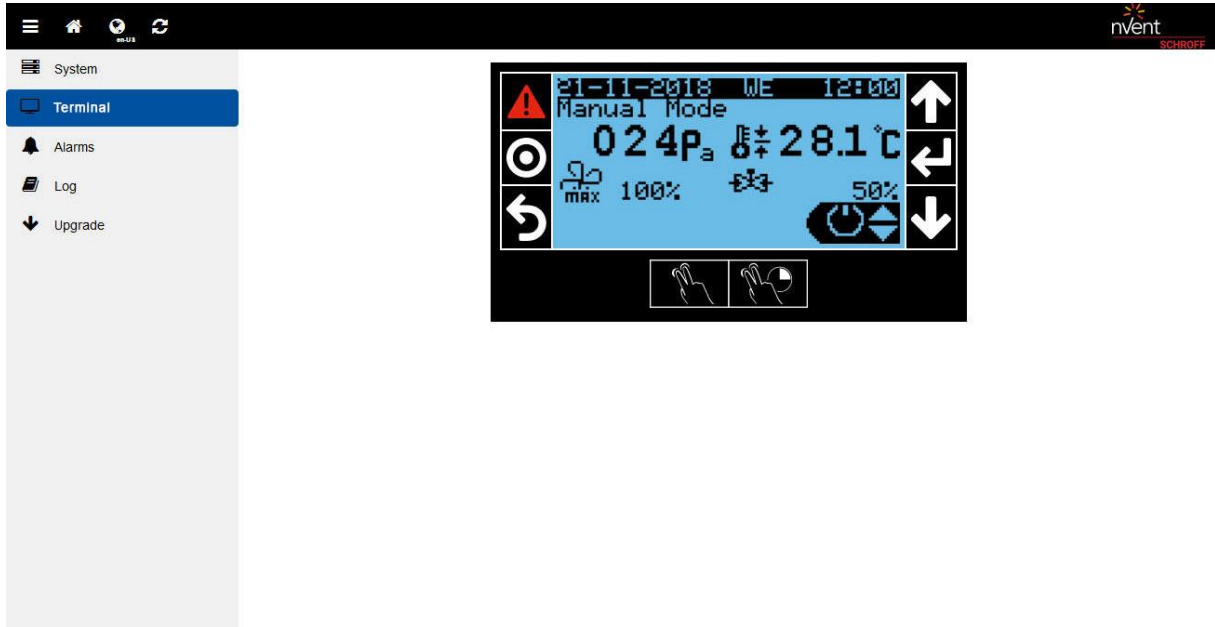

Screen Alarms

The screenshot shows the 'Alarms' screen in the nVent interface. The left navigation menu has 'Alarms' selected. The main area displays a table of alarm events. At the top right of the table area, there are filter icons for 'ALL', 'INFO', 'WARN', 'ERR', 'CRIT', 'OFF', and 'ON'. Below the table, it says 'Showing 1 to 16 of 16 rows' and '25 rows per page'. An 'Export' button is located at the bottom right.

Start time	Stop time	Description	Sample 1	Sample 2
21/11/2018 09:15:30	-	Differential Air Pressure	Air Differential Pressure -- Error -4	
19/11/2018 15:59:35	-	Differential Air Pressure	Air Differential Pressure -- Error -4	
16/11/2018 17:13:01	-	Differential Air Pressure	Air Differential Pressure -- Error -4	
16/11/2018 16:04:03	-	Differential Air Pressure	Air Differential Pressure -- Error -4	
16/11/2018 15:45:18	-	Differential Air Pressure	Air Differential Pressure -- Error -4	
16/11/2018 12:25:08	-	Differential Air Pressure	Air Differential Pressure -- Error -4	
16/11/2018 11:55:41	-	Differential Air Pressure	Air Differential Pressure -- Error -4	
16/11/2018 11:42:53	-	Differential Air Pressure	Air Differential Pressure -- Error -4	
15/11/2018 15:28:35	-	Differential Air Pressure	Air Differential Pressure -- Error -4	
15/11/2018 10:17:23	-	Differential Air Pressure	Air Differential Pressure -- Error -4	
15/11/2018 09:52:04	-	Differential Air Pressure	Air Differential Pressure -- Error -4	
14/11/2018 14:19:46	-	Differential Air Pressure	Air Differential Pressure -- Error -4	
14/11/2018 14:11:38	14/11/2018 14:13:35	Sensor Cold Air Bottom	Temperature Cold Air Bottom - Error -1	
14/11/2018 14:11:38	14/11/2018 14:13:35	Sensor Cold Air Top	Temperature Cold Air Top -- Error -1	
14/11/2018 14:11:28	14/11/2018 14:13:45	Warm Air too High		
14/11/2018 14:11:28	14/11/2018 14:13:31	Cold Air too High		

Screen Log

nvent SCHROFF

- System
- Terminal
- Alarms
- Log
- Upgrade

Periodic logs

Name	# of records	Interval [s]
PeriodicLog	25920	10

Description	Visible	Axis	Color	Style
AI_FLOW_SIG.Val_r	<input checked="" type="checkbox"/>	Primary	Green	Line
AI_AIR_OUT_Top.Val_r	<input checked="" type="checkbox"/>	Primary	Red	Line
AI_AIR_OUT_BOTTOM.Val_r	<input checked="" type="checkbox"/>	Primary	Yellow	Line
AI_WATER_IN.Val_r	<input checked="" type="checkbox"/>	Primary	Blue	Line
AI_WATER_OUT.Val_r	<input checked="" type="checkbox"/>	Primary	Purple	Line
AI_AIR_IN_BOTTOM.Val_r	<input checked="" type="checkbox"/>	Primary	Light Blue	Line
AI_AIR_IN_Top.Val_r	<input checked="" type="checkbox"/>	Primary	Orange	Line
T_Air_OUT_Top_r	<input checked="" type="checkbox"/>	Primary	Green	Line
T_Air_OUT_Bottom_r	<input checked="" type="checkbox"/>	Primary	Orange	Line
T_Water_IN_r	<input checked="" type="checkbox"/>	Primary	Red	Line
T_Water_OUT_r	<input checked="" type="checkbox"/>	Primary	Dark Blue	Line
POU_Water_Control.PIDout_r	<input checked="" type="checkbox"/>	Primary	Blue	Line
T_Air_IN_Top_r	<input checked="" type="checkbox"/>	Primary	Green	Line
T_Air_IN_Bottom_r	<input checked="" type="checkbox"/>	Primary	Red	Line
Water_Pressure_r	<input checked="" type="checkbox"/>	Primary	Yellow	Line
POU_Water_Control.Req_3point_r	<input checked="" type="checkbox"/>	Primary	Blue	Line
POU_Water_Control.oPOSITION_r	<input checked="" type="checkbox"/>	Primary	Purple	Line

Interval

Quick load: from Days ago

Start time: Stop time:

[Load](#)

Screen Upgrade

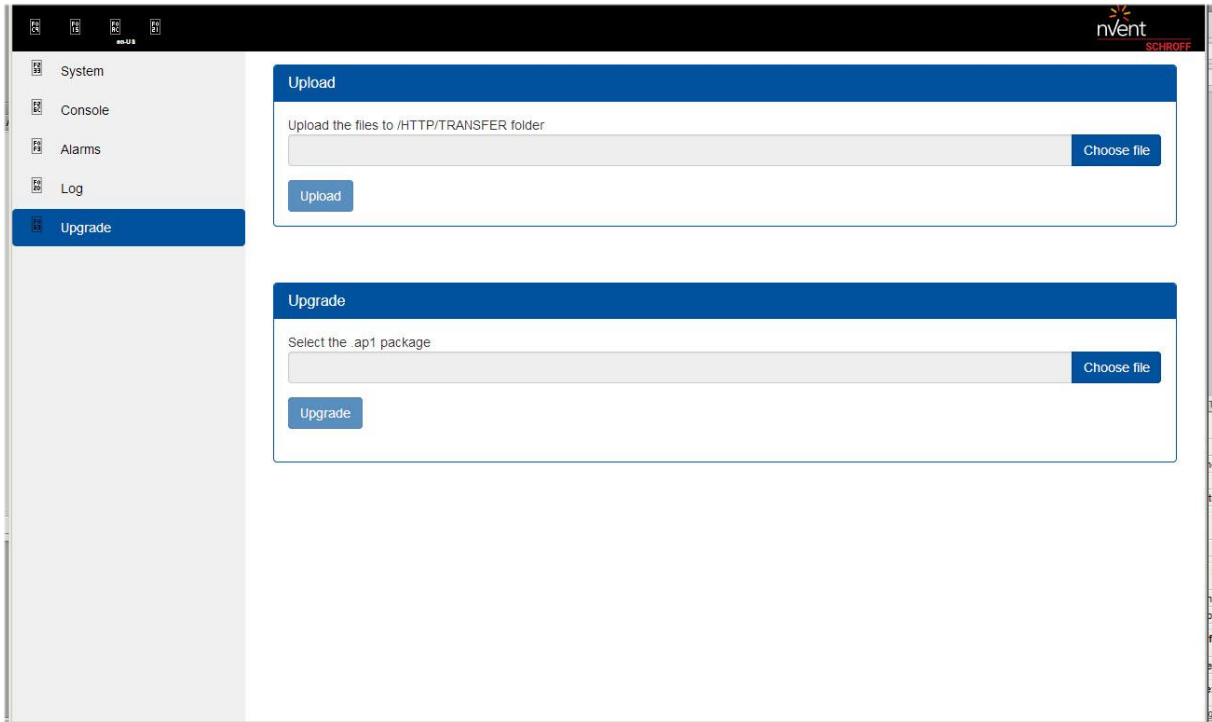





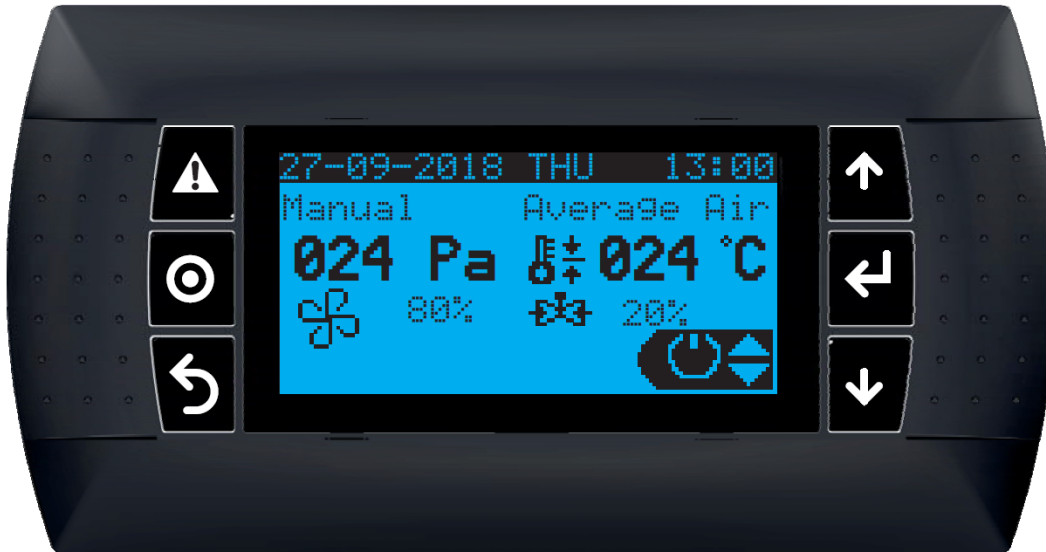

The screenshot shows the nVent SCHROFF web interface for screen upgrade. The interface features a dark top navigation bar with the nVent SCHROFF logo. On the left, there is a sidebar menu with the following items: System, Console, Alarms, Log, and Upgrade (which is currently selected and highlighted in blue). The main content area is divided into two sections. The first section is titled 'Upload' and contains the instruction 'Upload the files to /HTTP/TRANSFER folder'. Below this instruction is a file selection input field with a 'Choose file' button to its right, and an 'Upload' button below the input. The second section is titled 'Upgrade' and contains the instruction 'Select the .ap1 package'. Below this instruction is another file selection input field with a 'Choose file' button to its right, and an 'Upgrade' button below the input.

4.2 Display

The display is mounted on the front door of the LHX+ 10130-326/327 cabinets and allows configuring the LHX+ controller or retrieve the operating parameters.



	UP button	Scroll up or increase the value of a parameter.
	DOWN button	Scroll down or decrease the value of a parameter.
	ENTER button	Scroll through parameters or enter parameters.
	ESCAPE button	Return to the previous screen.
	PROG button	Enter the program menu. Menu Only available for service personnel.
	ALARM button	Displays current alarms.



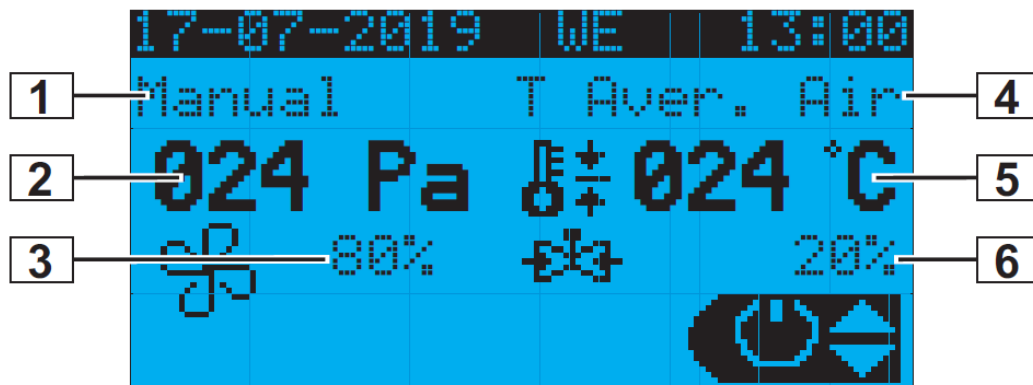

4.2.1 Display Overview











- | | | | |
|---|----------------------------|---|------------------------------------|
| 1 | Fan control operating mode | 4 | Temperature control operating mode |
| 2 | Differential pressure | 5 | Current temperature |
| 3 | Fan speed | 6 | Opening ratio water valve |

	<p>The temperature displayed depends on the operating mode of the temperature control. In the example above, it is the average of the cold air temperature sensors.</p>
---	---

4.2.2 Display menu

   	(I1) Status Air Probes	
	Cold Top	Cold Air Temp. (top)
	Cold Bottom	Cold Air Temp. (bottom)
	Warm Top	Warm Air Temp. (top)
	Warm Botto	Warm Air Temp. (bottom)
	(I2) Status Air Probes	
	Diff Press	Press. Diff. AIR Inlet/Outlet
	(I3) Status Water Probes (Only with Water Kit)	
	T Return	Temp. Return Water
	Flow	Water Flow
	(I5) Status Fans	
	Setpoint	Fan Setpoint
	Fan1	Current Speed Fan1
	Fan2	Current Speed Fan2
	(I6) Status Outputs	
	Valve Open	Water Valve Open Switch State
Valve Close	Water Valve Close Switch State	
Alarm 1	Alarm 1 Switch State	
Alarm 2	Alarm 2 Switch State	
Alarm 3	Alarm 3 Switch State	
Pump	Pump Switch State	
(IM) Info		
Press ENTER for more information		

        	(S1) Control Fans	
	Control Mode	Pressure diff / Manual
	Setpoint/Speed	Pa / %
	(S2) Control Valve	
	Control Mode	Air temp / Manual
	Setpoint/Position	°C / %
	(S3) Control Alarm	
	Allowed Temp Setpoint Exceedance	°C
	(S4) Configuration Fans	
	Variant	1 Fan/2 Fan
	(S5) TCP/IP Settings	
	DHCP	ON/OFF
	IP	. . .
	Mask	. . .
	Gateway	. . .
	
	(S6) Modbus RTU Slave Settings	
	Adress:	1-255
Baudrate:	9600-57600	
Stopbits:	1/2	
Parity:	Odd/Even/None	

4.2.3 Settings

The cold air temperature is detected by 2 temperature sensors. The temperature sensors are mounted in front of the 19" plane at different heights to compensate the temperature stratification.

As a control variable for the opening behavior of the control valve, the temperature of the lower ("cold bottom"), the upper ("cold top") or the average value of these temperature sensors can be used.

In addition to the control via temperature sensors, it is also possible to set the opening ratio of the water valve manually (in % opening ratio).

Fan control variables

SET → (S1) Control fans

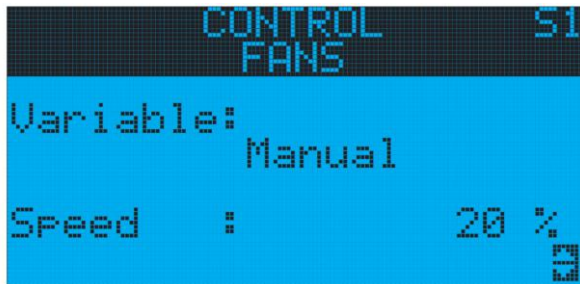

The following parameters are available:

- Differential Pressure
- Manual

In manual mode, the fan speed (20 % - 100 %) can be set. If the control is via the differential pressure sensor, the pressure can be set from -150 Pa to +150 Pa.

Water valve control variables

SET → (S2) Control Valve

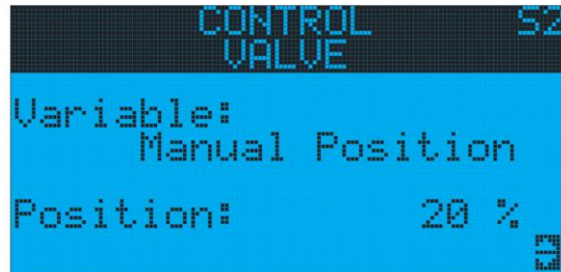

The following parameters are available:

- Average Air Temp
- Temp Air Bottom
- Temp Air Top
- Manual

If a temperature sensor makes the control, the temperature can be set in °C (°F), with manual control, the opening ratio of the water valve can be set in %.

Define allowed temperature setpoint exceedance

SET → (S3) Control Alarm



5 Maintenance

If the operating conditions have been observed, the LHX+ is maintenance-free. The fan trays can be replaced.

5.1 Fan tray replacement

ATTENTION

The cooling module must be switched off before removing the fan.

If this is not done automatically, e.g. by the door contact switch, please unplug the power plug.

Steps

- Press down the lever (1)
- Pull the Fan Tray to the front by the handle (2)
- Remove the fan tray upwards (3)
- Installation in reverse order

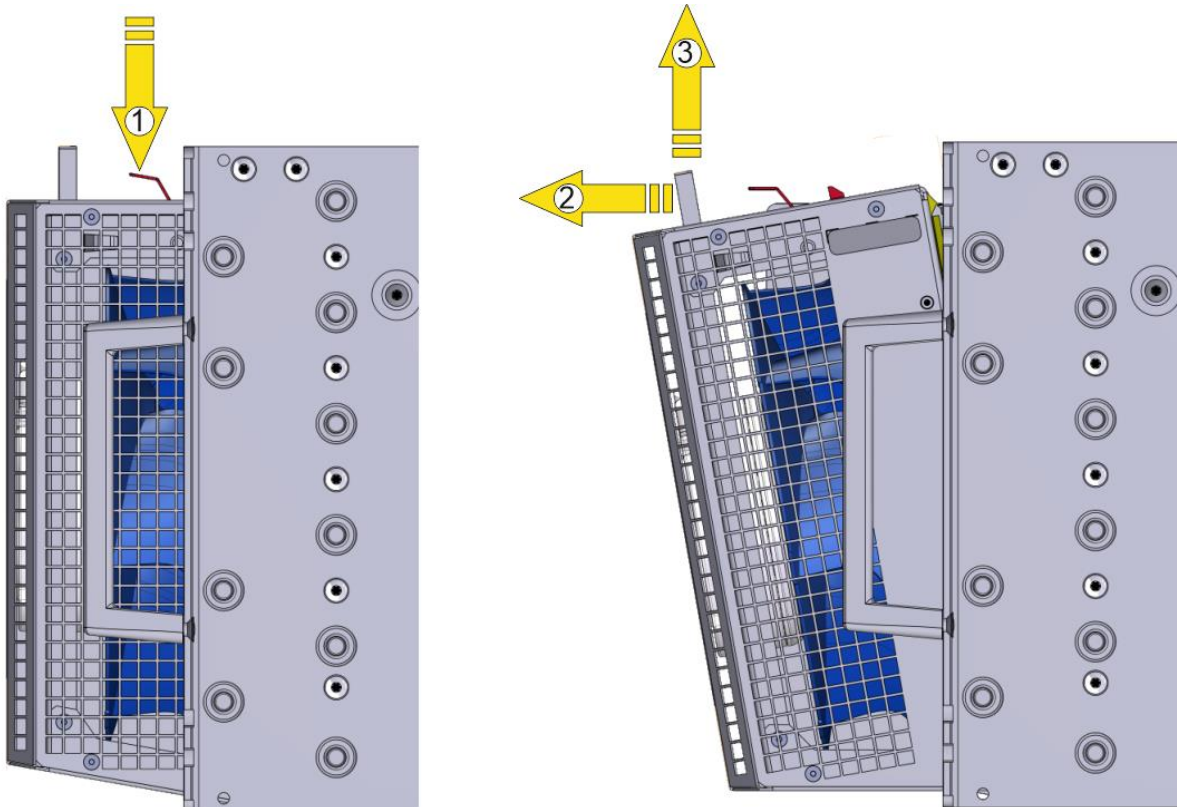

6 Optional water kit

In order to monitor additional operating parameters, a water kit (available as an accessory) can be mounted.

The water kit is mounted in the water return and monitors water flow and return temperature.



If the water kit is retrofitted, the controller must be configured accordingly. For further information please contact SCHROFF Service.

Water kit:

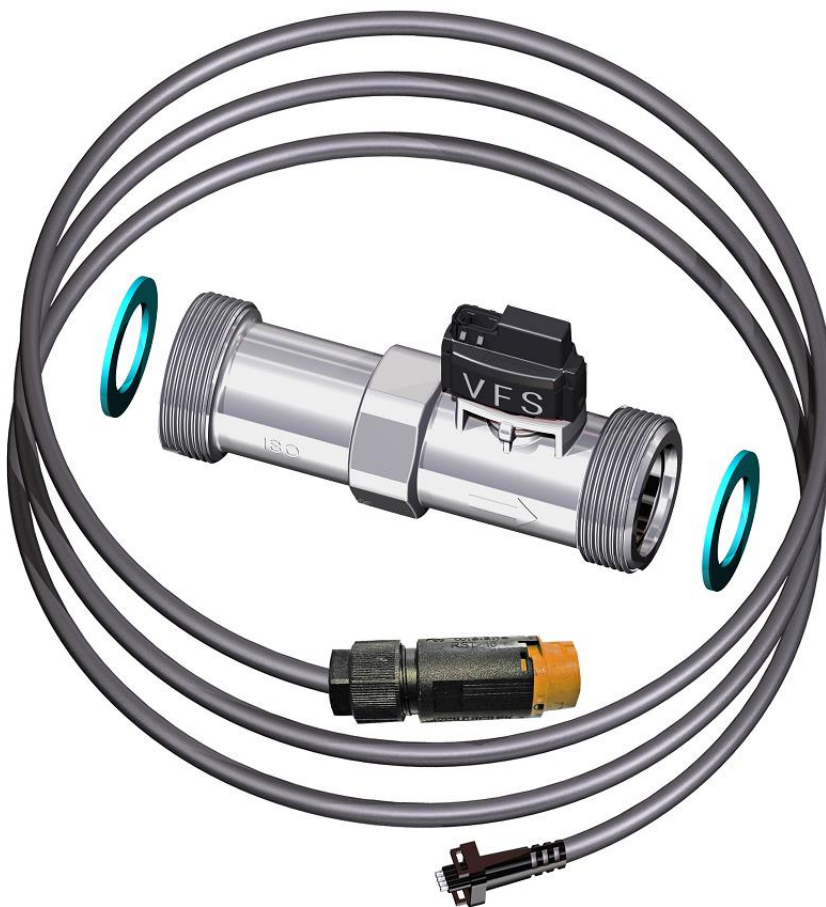

6.1 Installing the water kit

ATTENTION

Outflow of cooling water can cause damage!

- Works on the cooling water supply should be carried out by a refrigeration engineer or suitably trained plumber.

- Close the tap in the water supply
- Open the vent valve (1)
- Open the two union nuts (2)
- Remove the pipe (3)
- Mount the water kit with the gaskets (4)
- Mount the connection cable between the water kit and the controller.
- Connect the cable to the connector (W15) at the controller box
- Vent the system

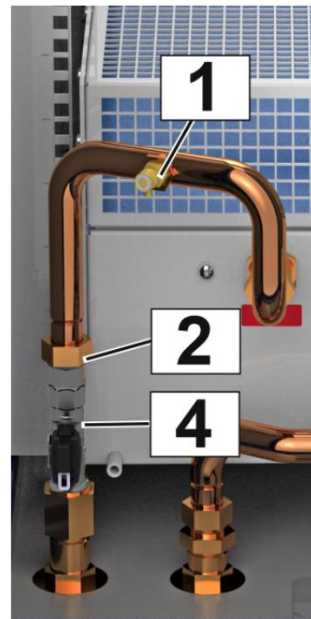
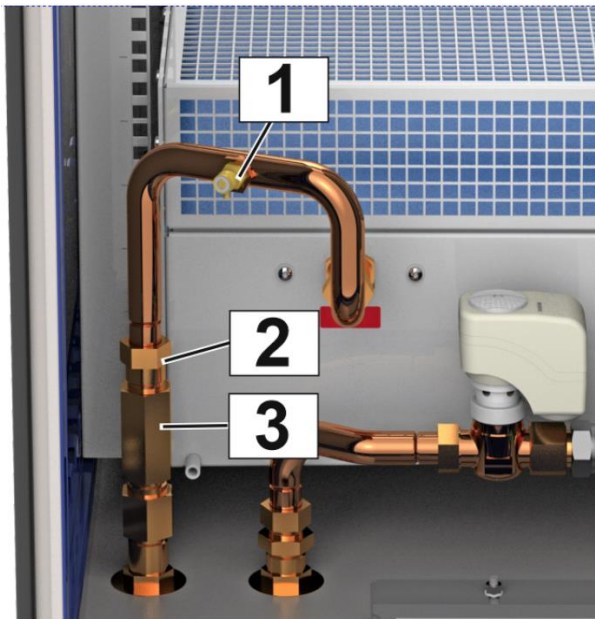

7 Dismantling, storage and disposal

7.1 Safety rules for dismantling, storage and disposal

⚠ WARNING	
	<p>Risk of injury and/or material damage from falling or tipping loads!</p> <ul style="list-style-type: none"> • When transporting the cabinet with a pallet truck, forklift or crane, do not step under the suspended load. • Only use approved equipment and slings to lift the cabinet. • During transport and dismantling, the corresponding personal protective equipment must be worn. • The cabinet is top-heavy and can tip over. At least 2 people are required when moving and unpacking the cabinet

⚠ WARNING	
	<p>Risk of accidents due to insufficiently qualified personnel!</p> <ul style="list-style-type: none"> • The dismantling may only be carried out by qualified personnel who are authorized to do so according to the valid safety regulations, e.g. by authorized specialized companies or authorized departments of the company. • When dismantling the system, the corresponding personal protective equipment must be worn.



Use eye protection!



Use hand protection!



Use foot protection!



Use head protection!

The specified personal protective equipment must be used during all assembly, dismantling and transport work.

ATTENTION
<p>Freezing hazard!</p> <p>The cooling unit may be damaged if the cooling medium freezes inside the unit. Drain the cooling unit completely prior to transporting or storage at temperatures below 0 °C.</p>

7.2 Dismantling

ATTENTION

Outflow of cooling water can cause damage!

- Works on the cooling water supply should be carried out by a refrigeration engineer or suitably trained plumber.

Before any dismantling work can be started, the controller and cooling module must be disconnected from the mains.

The cooling water supply and return must be closed and the cooling module must be drained.

Procedure:

- Disconnect the power supply of the cabinet from the mains
- Close the shut-off valves for the water supply and return.
- Disconnect the screw connections for the water supply and return under the cabinet floor, collect the leaking water.
- Close the water supply and return lines on the cabinet to prevent the water remaining in the heat exchanger from leaking out.

7.3 Storage

- The cooling unit must be completely drained before storage.
- If complete draining is not possible, flush the cooling unit with a suitable antifreeze agent.
- Ensure that the ambient conditions for storage comply with the specifications in the "Technical data" chapter.
- Protect the cabinet from dirt and moisture by using suitable packaging material.

7.4 Disposal

The system must be recycled in an environmentally friendly manner and disposed of properly.

A specialized company can take over this task.

All regulations of the national legislation applicable in your country must be adhered to.

8 Technical data

Type	LHX+ 5 kW	LHX+ 5 kW	LHX+ 10 kW
Part No.	10130-325	10130-326	10130-327
Part No. Heat Exchanger	29714-017	29714-017	29714-016
Cooling capacity			
Usable cooling capacity (cooling water inlet temperature 10 °C, air exit temperature 20 °C)	5 kW	5 kW	10 kW
Water circuit			
Cooling medium ¹⁾	Water	Water	Water
Water inlet temperature ²⁾	6...25 °C	6...25 °C	6...25 °C
Water flow	Up to 2.0 m ³ /h	Up to 2.0 m ³ /h	Up to 2.0 m ³ /h
Max. water pressure	typical: 6 bar peak: 10 bar	typical: 6 bar peak: 10 bar	typical: 6 bar peak: 10 bar
Static pressure loss in device at 0.5 m ³ /h	0,2 bar	0,2 bar	0,2 bar
Water conduit	Copper	Copper	Copper
Water connection inlet/outlet	G3/4" (inside conic)	G3/4" (inside conic)	G3/4" (inside conic)
Connection condensate drain	Ø10 mm (outside)	Ø10 mm (outside)	Ø10 mm (outside)
Air circuit			
Air flow	990 m ³ /h	990 m ³ /h	1790 m ³ /h
Electrical data			
Supply voltage, single phase	230 V AC, 50/60 Hz	230 V AC, 50/60 Hz	230 V AC, 50/60 Hz
Power consumption	Controller: 24 W Heat Exchanger: 170 W	Controller: 24 W Heat Exchanger: 170 W	Controller: 24 W Heat Exchanger: 340 W
Protection fuse	Controller: 2 AT Heat Exchanger: 2 AT	Controller: 2 AT Heat Exchanger: 2 AT	Controller: 2 AT Heat Exchanger: 4 AT
General Data			
Cabinet type of protection	IP55	IP55	IP55
Ambient temperature during transport	-25...70 °C	-25...70 °C	-25...70 °C
Ambient temperature outside of cabinet (during operation)	5...50 °C	5...50 °C	5...50 °C
Relative humidity level	5...95 %	5...95 %	5...95 %
Sound Power LWA (100 % Fan Speed)	72,6 dB (A)	72,6 dB (A)	76,3 dB(A)
Sound Pressure LPA (100 % Fan Speed)	65,8 dB (A)	65,8 dB (A)	69,6 dB (A)
Weight: cabinet with heat exchanger	153 kg	173 kg	169 kg
Weight with package	163 kg	184 kg	180 kg
Heat exchanger dry/filled with water	17/18 kg	17/18 kg	20/21 kg
Dimensions of air/water heat exchanger			
Height	266 mm = 6 U	266 mm = 6 U	266 mm = 6 U
Width	483/448 mm (19")	483/448 mm (19")	483/448 mm (19")
Depth	653 mm	653 mm	653 mm
Dimensions of cabinet			
Height	2113 mm	2114,5 mm	2113 mm
Width	600 mm	600 mm	600 mm
Depth	822,5 mm	1048 mm	1022,5 mm

8.1 Scope of delivery

Part No.: 10130-325

Pos.	Designation	Qty
1)	VARISTAR FRAME SL 2000x600x800 mm (H/W/D), RAL7021	1x
2)	VARISTAR IP GASKET KIT	1x
3)	BASE PLINTH H=100 mm, 3 COVERS + LEVELING FEETS + BRUSH AT THE REAR, RAL7021	1x
4)	BOTTOM PLATE 600x800 mm WITH IP CABLE ENTRY, ALUZINC COATED	1x
5)	TOP COVER 600x800 mm RAL7021	1x
6)	PANEL / SLIDE MOUNT 19" 42 U ALUZINC COATED	4x
7)	19" AIR BL.PANEL & GASKETS RAL7021	1x
8)	SLIDE RAIL STD 600 mm (2PCS)	1x
9)	6 U HEAT-EXCHANGER 5 kW 1 FAN	1x
10)	2 WAY VALVE AND ACTUATOR	1x
11)	WATER PIPEWORK INLET & OUTLET WITH VENT VALVE (G 3/4" CONE 60°)	1x
12)	CONTROLLER BOX UNIT & DIFF.PRESSURE SENSOR RAL7021	1x
13)	TEMPERATURE SENSOR KIT (X4)	1x
14)	FRONT DOOR 2000x600 mm RAL7021	1x
15)	DOOR SWITCH (FRONT DOOR)	1x
16)	REAR PANEL 2000x600 mm RAL7021	1x
17)	DOOR SWITCH (REAR PANEL)	1x
18)	SIDE PANEL 2000x800 mm (2X)	1x
19)	LABEL WITH SERIAL N° & CE FOR CABINET AND CONTROLLER	2x

Part No.: 10130-326

Pos.	Designation	Qty
1)	VARISTAR EMC FRAME SL 2000x600x1000 mm (H/W/D), RAL7021	1x
2)	VARISTAR EMC GASKET KIT	1x
3)	BASE PLINTH H=100 mm, 3 COVERS + LEVELING FEETS + BRUSH AT THE REAR, RAL7021	1x
4)	EMC BOTTOM PLATE 600x1000 mm WITH EMC CABLE ENTRY, ALUZINC COATED	1x
5)	EMC TOP COVER 600x1000 mm RAL7021	1x
6)	PANEL / SLIDE MOUNT 19" 42 U ALUZINC COATED	4x
7)	19" AIR BL.PANEL & GASKETS RAL7021	1x
8)	SLIDE RAIL STD 600 mm (2PCS)	1x
9)	6 U HEAT-EXCHANGER 5 kW 1 FAN	1x
10)	2 WAY VALVE AND ACTUATOR	1x
11)	WATER PIPEWORK INLET & OUTLET WITH VENT VALVE (G 3/4" CONE 60°)	1x
12)	CONTROLLER BOX UNIT & DIFF.PRESSURE SENSOR RAL7021	1x
13)	TEMPERATURE SENSOR KIT (X4)	1x
14)	EMC FRONT DOOR 2000x600 mm WITH CUTOUT FOR DISPLAY RAL7021	1x
15)	DOOR SWITCH (FRONT DOOR)	1x
16)	EMC REAR DOOR 2000x600 mm RAL7021	1x
17)	DOOR SWITCH (REAR DOOR)	1x
18)	DISPLAY ON FRONT DOOR	1x
19)	EMC SIDE PANEL 2000x1000 mm (2X)	1x
20)	LED-700L LIGHT 24 V DC / 265 V AC PIR & INTER	1x
21)	LABEL WITH SERIAL N° & CE FOR CABINET AND CONTROLLER	2x





Part No.: 10130-327

Pos.	Designation	Qty
------	-------------	-----



SCHROFF

1)	VARISTAR EMC FRAME SL 2000x600x1000 mm (H/W/D), RAL7021	1x
2)	VARISTAR EMC GASKET KIT	1x
3)	BASE PLINTH H=100 mm, 3 COVERS + LEVELING FEETS + BRUSH AT THE REAR, RAL7021	1x
4)	EMC BOTTOM PLATE 600x1000 mm WITH EMC CABLE ENTRY, ALUZINC COATED	1x
5)	EMC TOP COVER 600x1000 mm RAL7021	1x
6)	PANEL / SLIDE MOUNT 19" 42 U ALUZINC COATED	4x
7)	19" AIR BL.PANEL & GASKETS RAL7021	1x
8)	SLIDE RAIL STD 600 mm (2PCS)	1x
9)	6 U HEAT-EXCHANGER 10 kW 2 FANS	1x
10)	2 WAY VALVE AND ACTUATOR	1x
11)	WATER PIPEWORK INLET & OUTLET WITH VENT VALVE (G 3/4" CONE 60°)	1x
12)	CONTROLLER BOX UNIT & DIFF.PRESSURE SENSOR RAL7021	1x
13)	TEMPERATURE SENSOR KIT (X4)	1x
14)	EMC FRONT DOOR 2000x600 mm WITH CUTOUT FOR DISPLAY RAL7021	1x
15)	DOOR SWITCH (FRONT DOOR)	1x
16)	EMC REAR PANEL 2000x600 mm RAL7021	1x
17)	DOOR SWITCH (REAR PANEL)	1x
18)	DISPLAY ON FRONT DOOR	1x
19)	EMC SIDE PANEL 2000x1000 mm (2X)	1x
20)	LED-700L LIGHT 24 V DC / 265 V AC PIR & INTER	1x
21)	LABEL WITH SERIAL N° & CE FOR CABINET AND CONTROLLER	2x

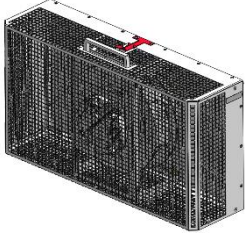
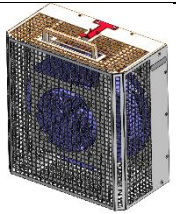
8.2 Spare parts

Spare parts		
Part No.	Item	
23130-666	Display	
23130-667	Door Switch Kit	
23130-668	Controller Box	
23130-669	Actuator and ball valve	
29714-026	Fan Tray LHX 5	
29714-025	Fan Tray LHX 10	

8.3 Accessoires

Accessoires		
Part No.	Item	
23130-660	LHX+ water hoses connection kit 1.5 m	
23130-661	LHX+ water hoses connection kit 4 m	
23130-663	Water flow and temperature sensor kit	

23130-662

Water hoses duct for rear panel

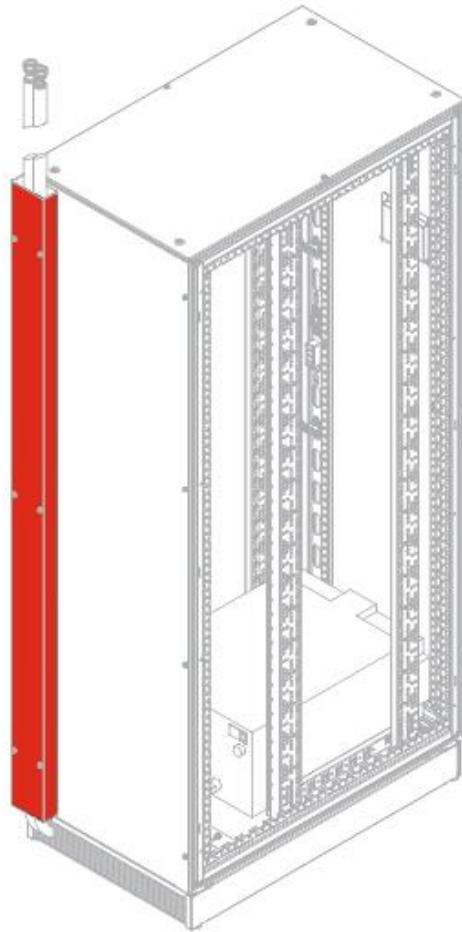

8.4 Cooling performance

Cooling performance LHX+ 5 kW

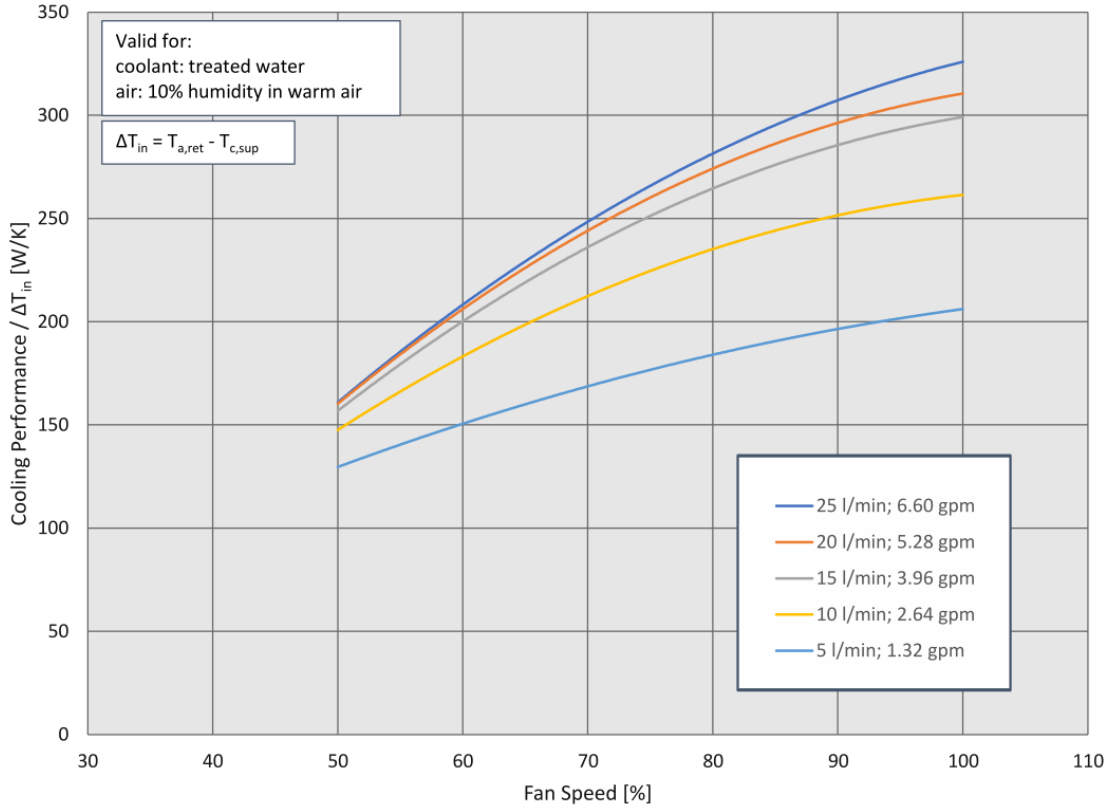

Cooling performance LHX+ 10 kW

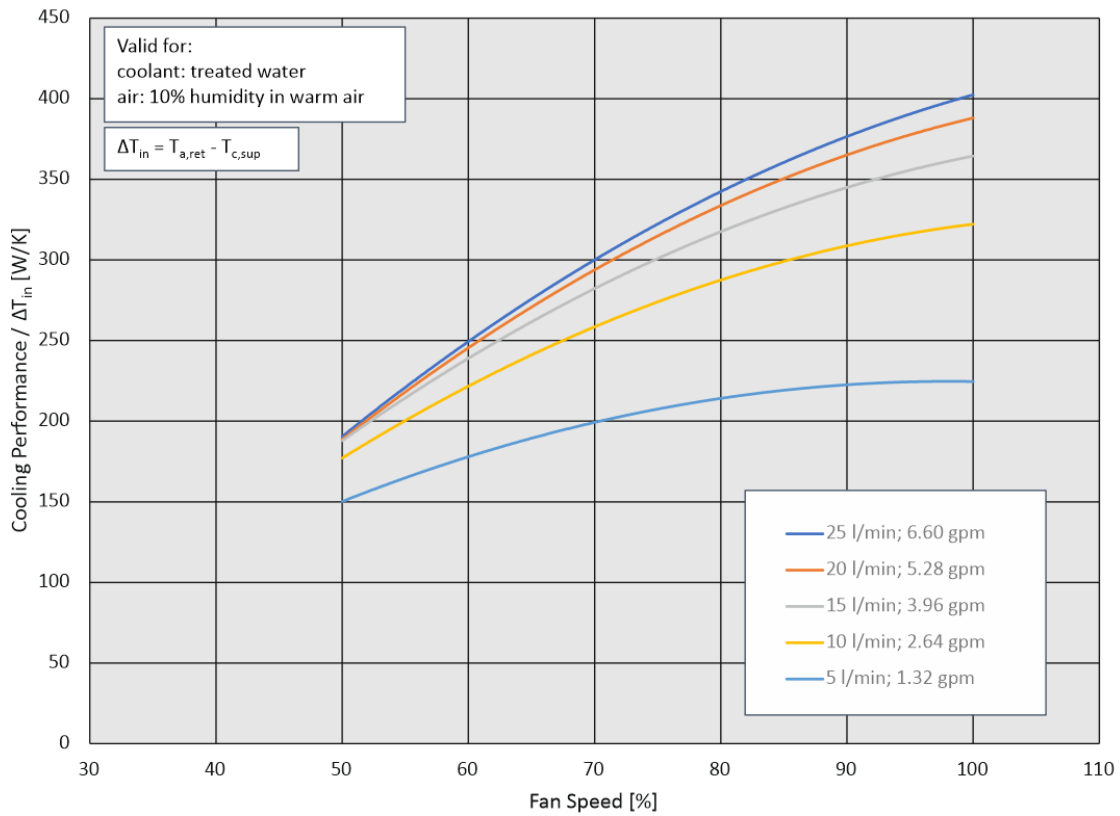

8.5 Air flow

Air flow LHX+ 5 kW

Control voltage [VDC]	Fan Speed [1/min]	Total air flow	
		[m ³ /h]	[CFM]
10	4354	987	581,2
9	4290	975	574,2
8	3788	864	508,8
7	3267	741	436,4
6	2765	624	367,5
5	2228	496	292,1
4	1726	380	223,8
3	1208	253	149,1

Air flow LHX+ 10 kW

Control voltage [VDC]	Fan Speed [1/min]	Total air flow	
		[m ³ /h]	[CFM]
10	4214	1790	1053,5
9	4204	1785	1050,6
8	3753	1598	940,5
7	3254	1377	810,4
6	2737	1155	679,8
5	2222	926	545,0
4	1712	707	416,1
3	1193	478	281

8.7 Noise Level

Noise level LHX+ 5 kW

Fan Speed (%)	Closed doors	
	Sound Power L _{WA} [dB(A)]	Sound Pressure L _{PA} [dB(A)] 0,2m distance
100	72,6	65,8
90	71,2	64,6
80	68,3	61,5
70	64,8	58,1
60	60,7	54,4
50	55,7	50,4
40	-	-

Noise level LHX+ 10 kW

Fan Speed (%)	Closed doors	
	Sound Power L _{WA} [dB(A)]	Sound Pressure L _{PA} [dB(A)] 0,2m distance
100	76,3	69,6
90	72,2	66,2
80	68,3	62,3
70	67,4	60,6
60	62,7	56,2
50	57,4	52,0
40	-	-

The reproduction, distribution and utilization of this document as well as the communication of its content, in any form and by any means, is prohibited without the prior written permission of the manufacturer. All rights reserved in the event of the grant of a patent, utility model or design.

Toute communication ou reproduction de ce document, toute exploitation ou communication de son contenu, sous quelque forme que ce soit, est formellement interdite sans la permission écrite de l'éditeur. Tous droits réservés pour le cas de la délivrance d'un brevet, d'un modèle d'utilité ou d'un modèle de présentation.

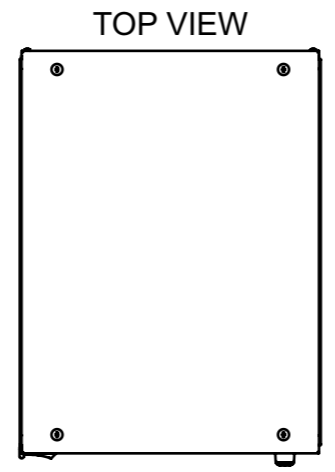
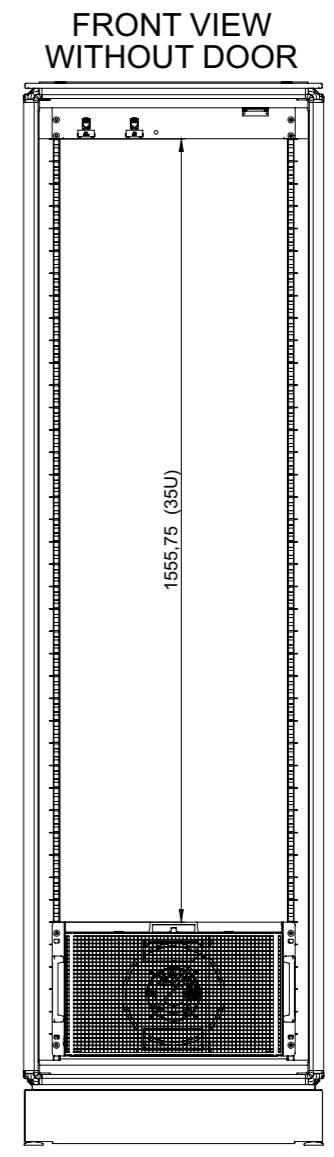
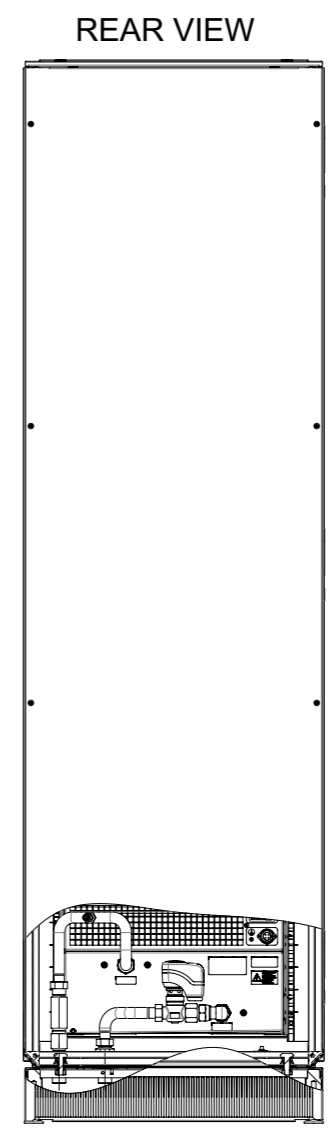
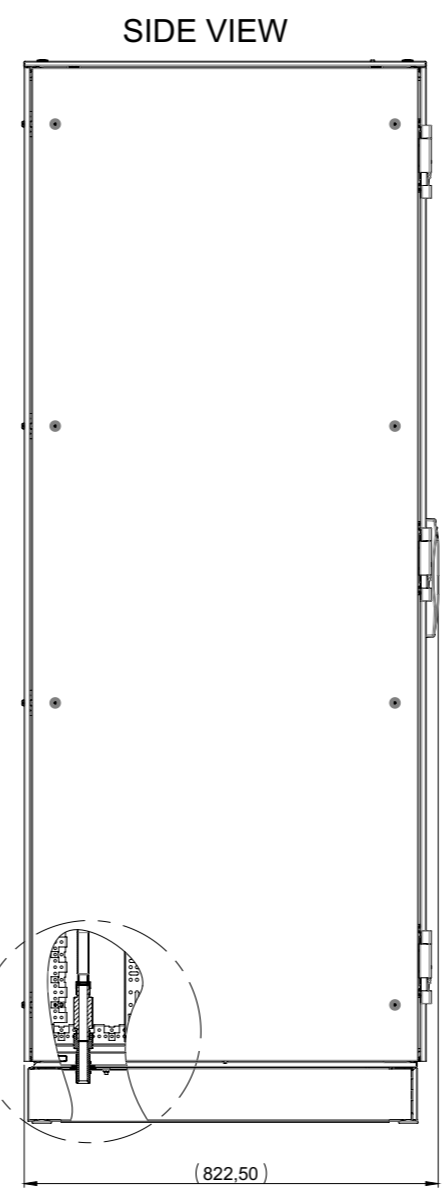
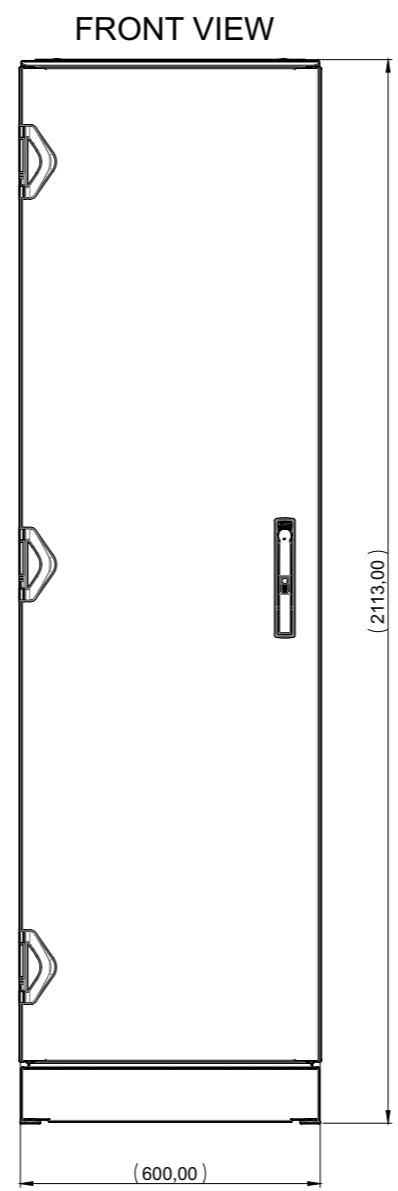
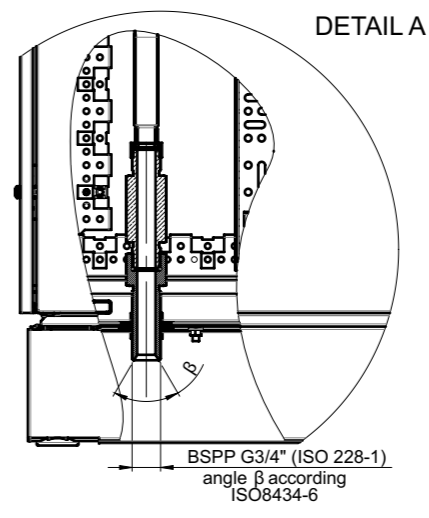
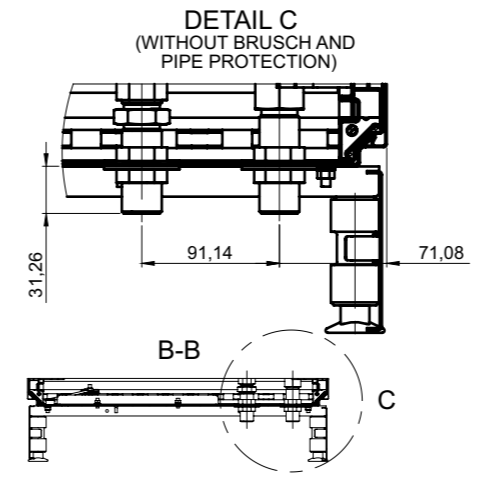
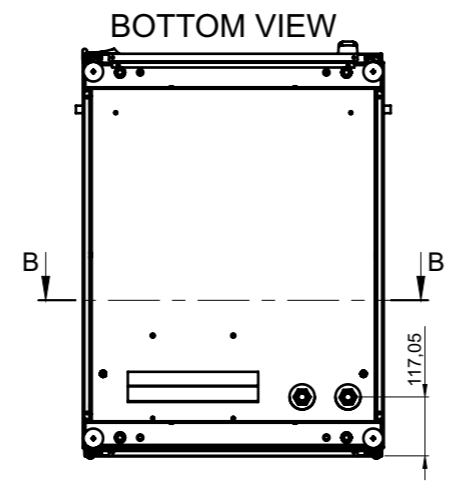
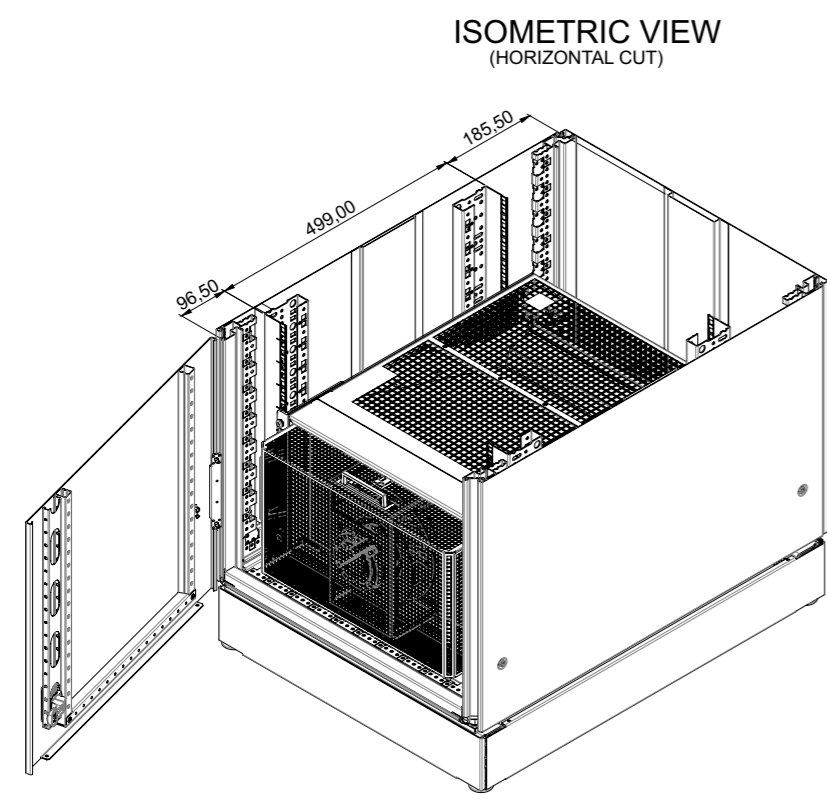

Utilisation initiale / Initial use	Echelle / Scale	Surface / Surface	mm²	Volume / Volume	mm³	Masse / Mass																																																								
<table border="1"> <tr> <td colspan="2">Matériau / Material</td> <td colspan="5">Épaisseur / Thickness</td> </tr> <tr> <td colspan="2">Pièce de base / Base part</td> <td colspan="5"></td> </tr> <tr> <td colspan="2">Libérateur / Approve</td> <td colspan="5">Désignation / Tab. variante</td> </tr> <tr> <td colspan="2">Nomme / Conform</td> <td colspan="5">Titre / Tab. variante</td> </tr> <tr> <td colspan="2">Vérifier / Check</td> <td colspan="5">Nom / Tab. variante</td> </tr> <tr> <td colspan="2">Dessiner / Draw</td> <td colspan="5">No. de plan / Drawing no. 10130-325</td> </tr> <tr> <td>Indice / Ref.</td> <td>ECC-No.</td> <td>Date / Date</td> <td>Nom / Name</td> <td colspan="3">Taille du tab. / Tab. Range</td> </tr> <tr> <td></td> <td></td> <td></td> <td></td> <td colspan="3">Modèle / Model 10130-325</td> </tr> </table>							Matériau / Material		Épaisseur / Thickness					Pièce de base / Base part							Libérateur / Approve		Désignation / Tab. variante					Nomme / Conform		Titre / Tab. variante					Vérifier / Check		Nom / Tab. variante					Dessiner / Draw		No. de plan / Drawing no. 10130-325					Indice / Ref.	ECC-No.	Date / Date	Nom / Name	Taille du tab. / Tab. Range							Modèle / Model 10130-325		
Matériau / Material		Épaisseur / Thickness																																																												
Pièce de base / Base part																																																														
Libérateur / Approve		Désignation / Tab. variante																																																												
Nomme / Conform		Titre / Tab. variante																																																												
Vérifier / Check		Nom / Tab. variante																																																												
Dessiner / Draw		No. de plan / Drawing no. 10130-325																																																												
Indice / Ref.	ECC-No.	Date / Date	Nom / Name	Taille du tab. / Tab. Range																																																										
				Modèle / Model 10130-325																																																										

| | | | | | | |

02/03/2021
 The reproduction, distribution and utilization of this document as well as the communication of its content in any form or by any means, without the prior written permission of the manufacturer, is prohibited. All rights reserved in the event of the grant of a patent, utility model or design.

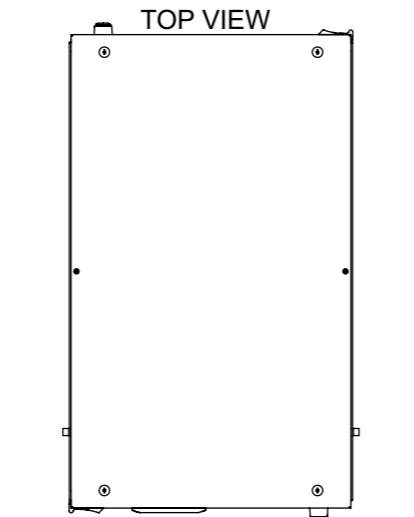
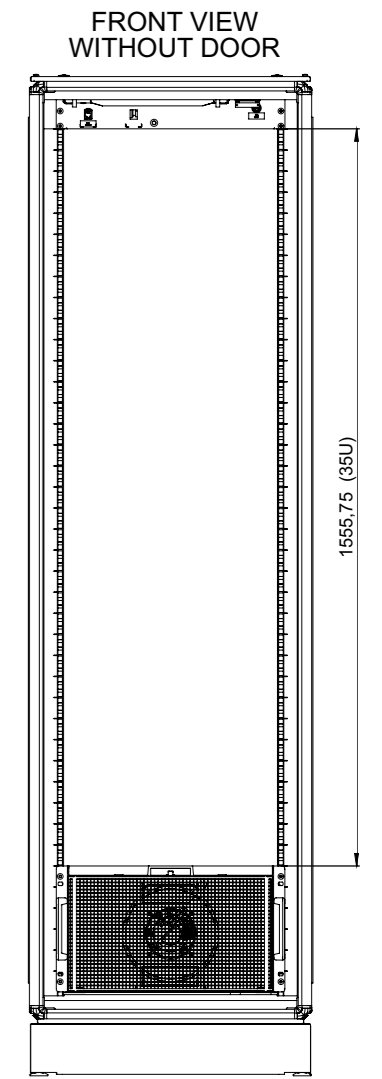
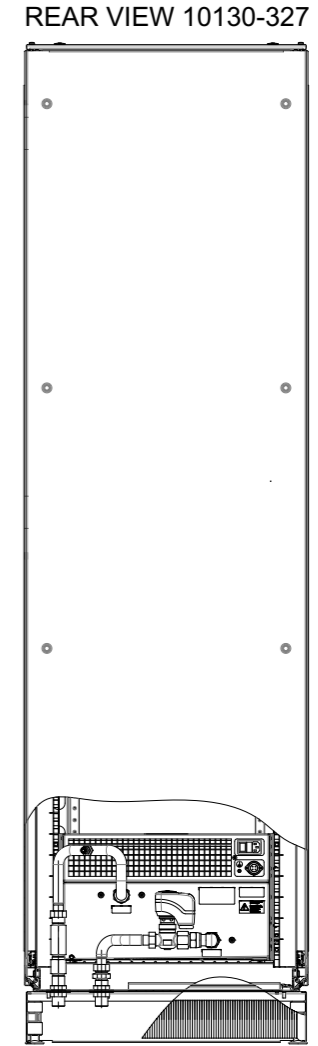
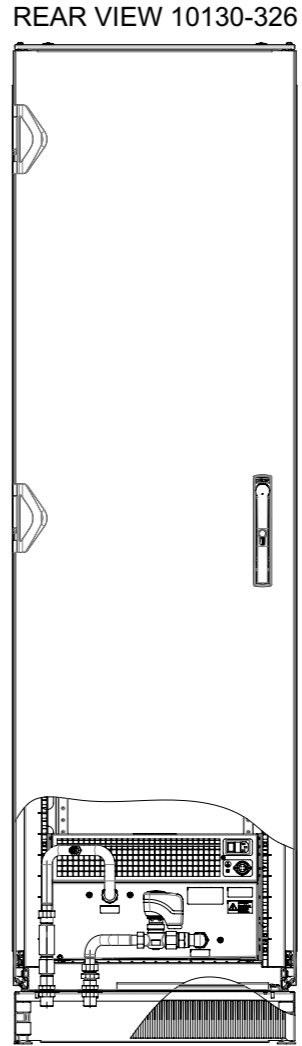
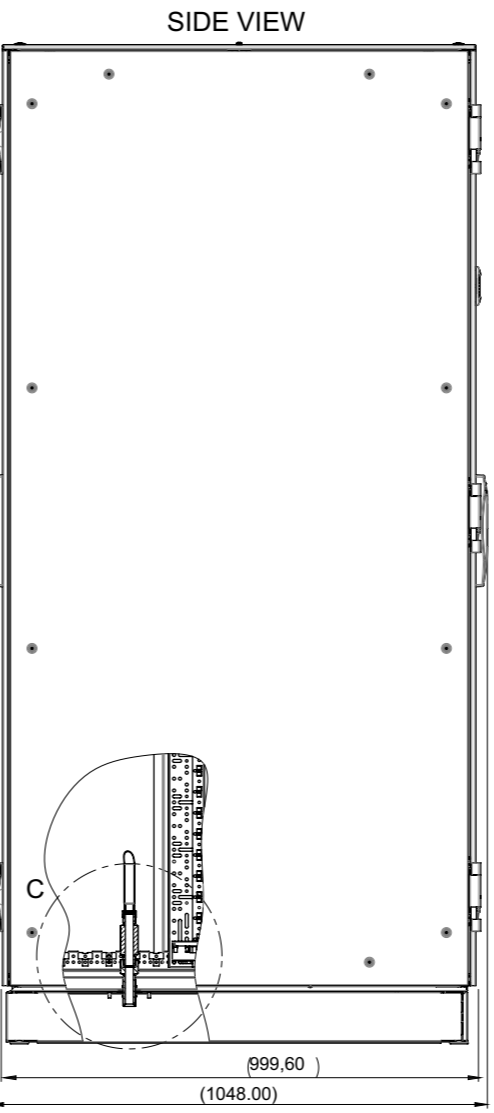
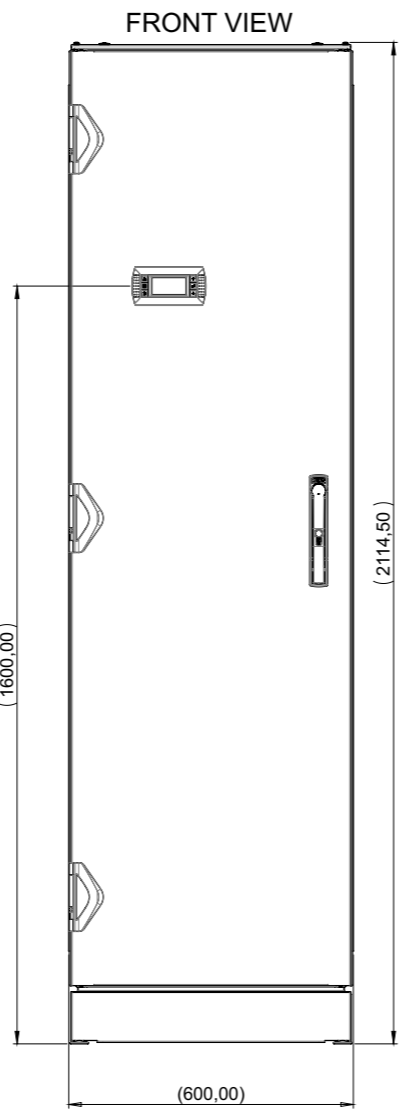
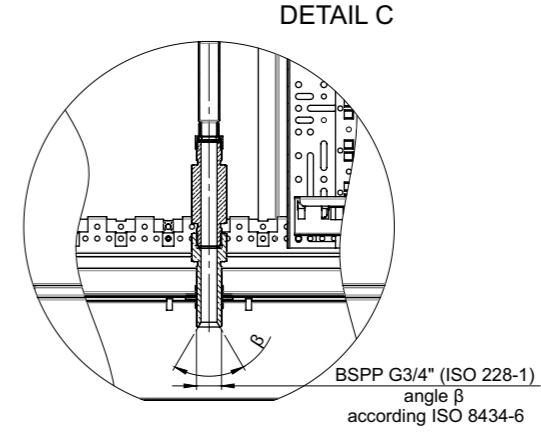
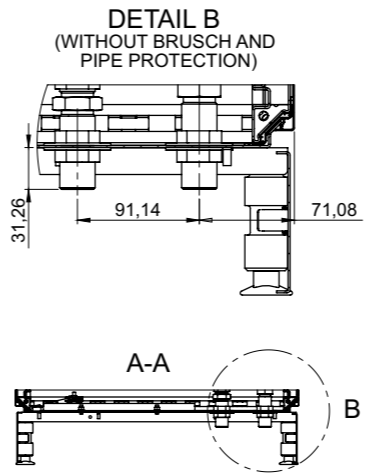
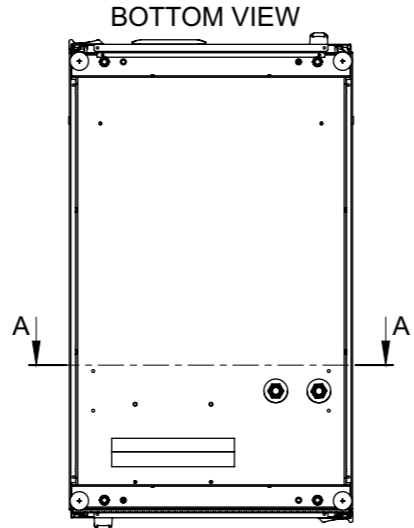
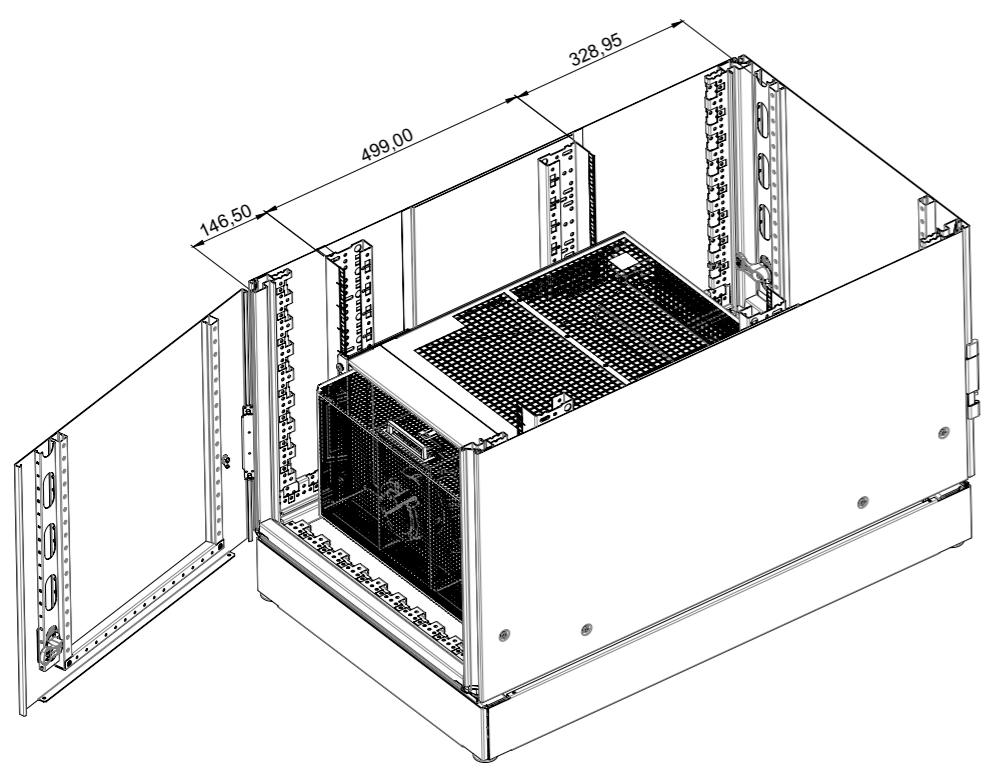

Toute communication ou reproduction de ce document, toute exploitation ou communication de son contenu, sans autorisation écrite de la Schrock, est formellement interdite. Toute réimpression, sans autorisation écrite de la Schrock, est formellement interdite. Tous droits réservés pour le cas de la délivrance d'un brevet, d'un modèle d'utilité ou d'un modèle de présentation.

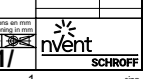

Utilisation initiale	Echelle	Surface	mm ²	Volume	mm ³	Masse	g
Initial use	Scale	Surface	mm ²	Volume	mm ³	Mass	g
Matériau		Epaisseur / Thickness					
Material		Thickness					
Pièce de base							
Basic part							
Libérer / Approved		Désignation					
Norme / Conformity		Titre variétés					
Vérifier / Check		Titre					
Dresser / Draw		Titre variétés					
Index	ECO-No	Date	Nom	No du plan / Drawing no.			
				10130-326/327			
				Titre au tab. / Title sheet			
				Modèle 327 / 326 Model			
				Std Origin Item			
				1/			

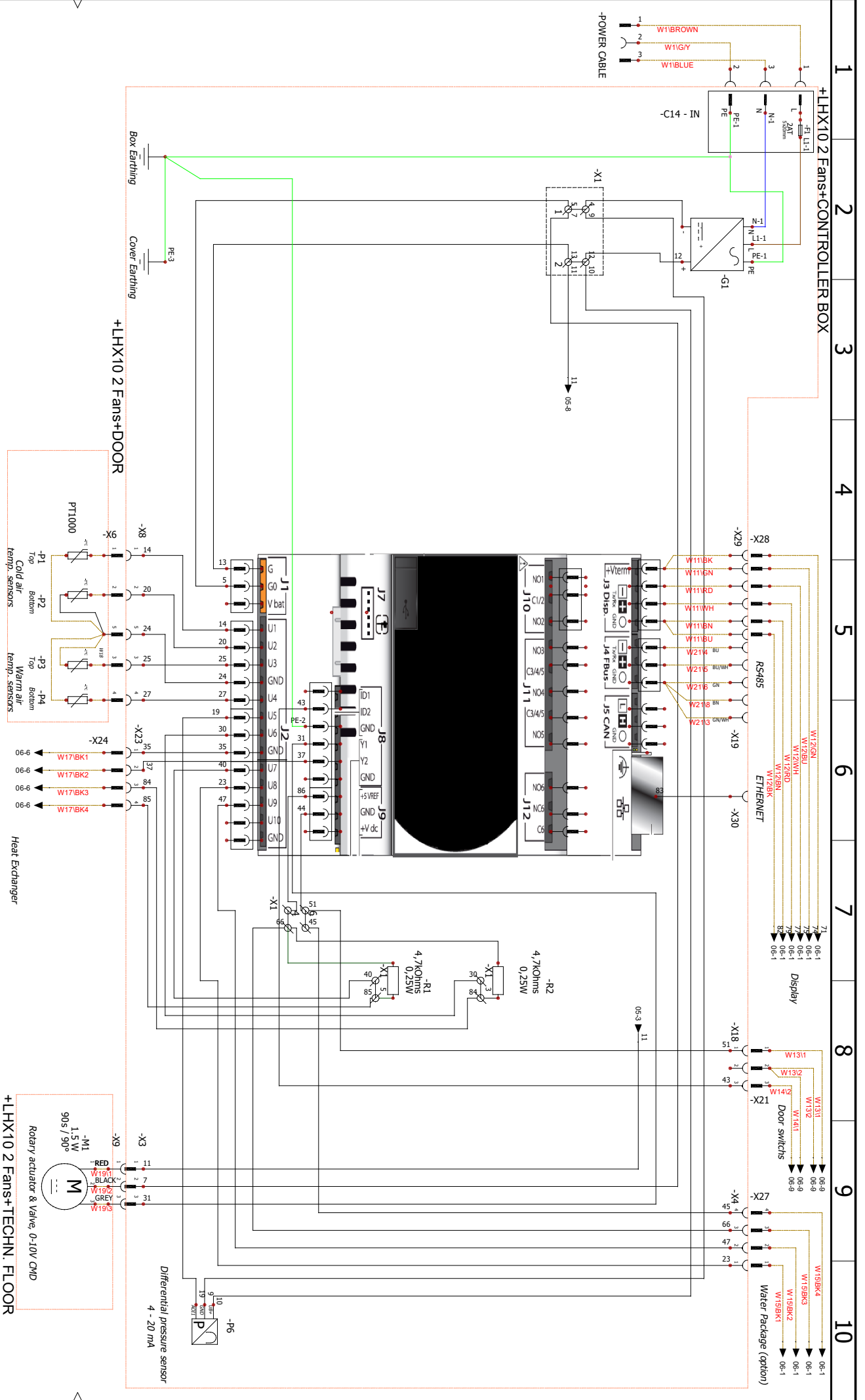



NO DU PLAN / DRAWING NO.: 72150-038

LOCALISATION / LOCATION: +LHX10 2 Fans

 		<h3 style="text-align: center;">Schéma électrique</h3>		FOLIO	
				05	
IND / REV	DATE / DATE	NOM / NAME	MODIFICATIONS / MODIFICATIONS	DATE / DATE	8
A	18/03/2020	EI124748		19/03/20	
DESIGNER / DRAWN F. HARTMANN					

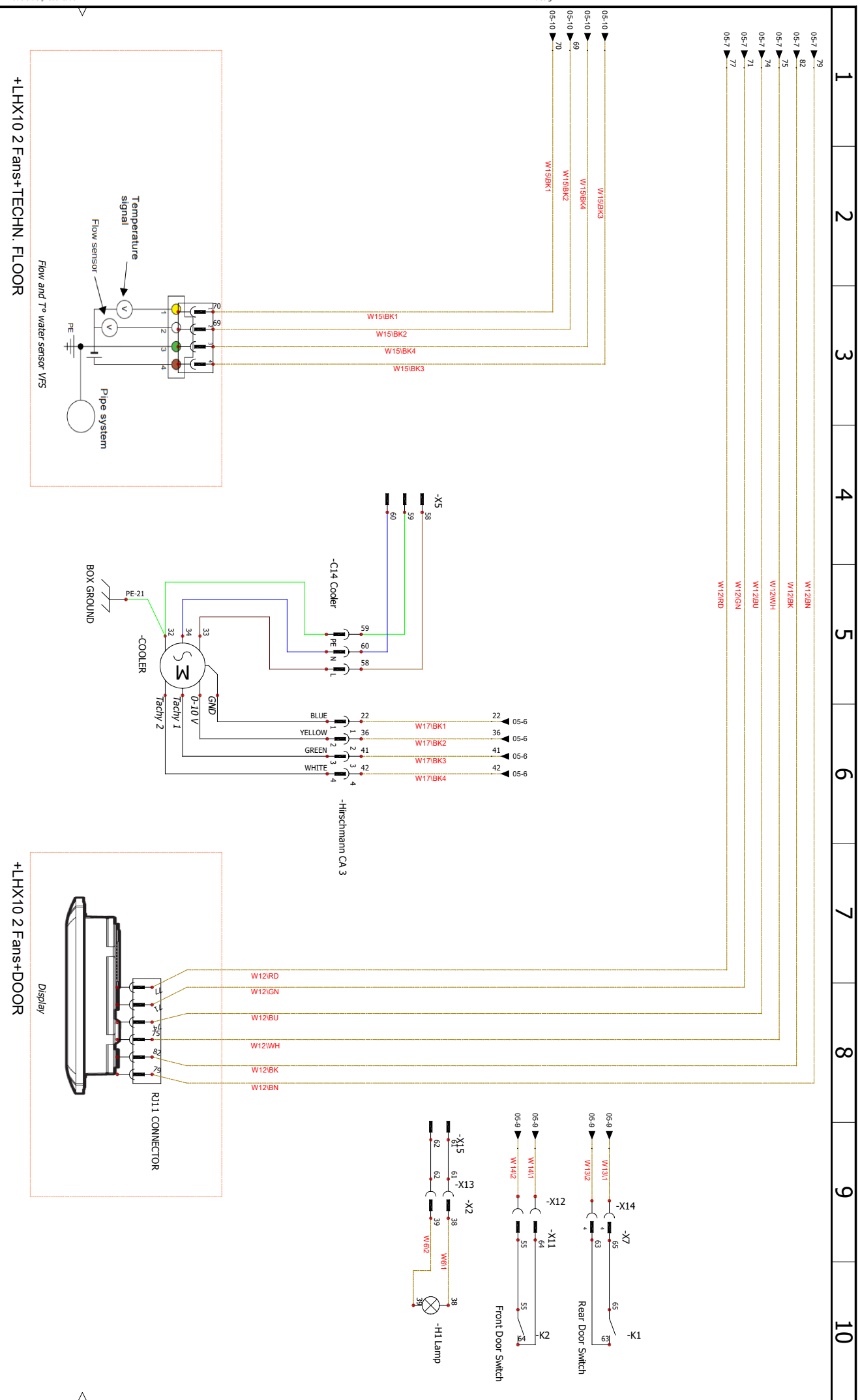

+LHX10 2 Fans+TECHN. FLOOR

+LHX10 2 Fans+DOOR

Schéma électrique



NO DU PLAN / DRAWING NO.: 72150-038

LOCALISATION / LOCATION: +LHX10 2 Fans

IND / REV	DATE / DATE	NOM / NAME	MODIFICATIONS / MODIFICATIONS
A	18/03/2020	E1124748	
DESIGNER / DRAWMAN		DATE / DATE	
F. HARTMANN		19/03/20	

FOLIO 06

8