



# IMG-4312-4G series

**Industrial IoT LTE Gateway with IEEE 802.11 b/g/n  
and 2x10/100Base-T(X), 1xRS-232/422/485 ports**

## Features

- Compact size industrial M2M gateway for remote access, data collection and end-devices control applications suitable for multiple IoT Cloud Platform interfaces
- Support **LTE Cat. 4** with up to 150Mbps downlink and 50Mbps uplink data rates
- Support single mini SIM card slot
- Support 2x 10/100Base-T(x) Ethernet ports
- Support 1x RS-232/422/485 Serial port in DB9 connector
- Support High Speed Wireless Connectivity: 802.11 b/g/n WLAN Wi-Fi interface with up to 150Mbps bandwidth
- Support **ORing Open Gateway** (protocol converter) software feature for user-friendly IIoT deployment
- Support **ORing Cloud Wizard** feature for easy and quick step-by-step device provisioning
- Support **Modbus TCP/RTU** industrial protocols
- Support **MQTT/MQTT Sparkplug B/CoAP/LWM2M** Cloud protocols
- Support **DHCP** server and forwarding through PPTP function
- Support **VPN** for secured network connection (OpenVPN, PPTP, IPSec)
- Support **NAT** (Network Address Translation)
- Support **Firewall** features
- Event warning by System logs, SNMP Trap, E-mail and SMS
- Redundant multiple host devices:  
5 host devices: Virtual COM, TCP Server, TCP Client mode, UDP mode (4 IP Ranges)
- Redundant 12~48VDC power input in terminal block
- **PoE power input** available (IMG-4312+-4G model) with 1kV isolation
- Rugged IP-30 casing design and wide operating temperature range for harsh environment operation
- DIN Rail and Wall mounting types
- Support **OpenWRT SDK** for project customization



## Introduction

**IMG-4312-4G** LTE cellular M2M Gateway is an innovative product for Cloud, Internet of Things and Industry 4.0 applications. It is a perfect choice for remote secured data collection from the factory floor (PLCs, machines, networking devices) and environmental sensors (temperature, humidity, noise, pollution, vibration etc.) as well as for serving control commands coming from Cloud Platforms for changing end-devices status.

**Connectivity:** **IMG-4312-4G** Gateway uses LTE module which supports **2G/3.5G/4G** technologies. The user has a possibility to choose between three different communication interfaces to connect his end-device: **Fast Ethernet ports, Serial port and Wireless Wi-Fi connectivity** with 150Mbps link speed. With **Modbus RTU and TCP** protocols the Gateway can easily communicate with any compatible device to poll and write all kind of data types. IMG-4312-4G can also transfer data to 5 host PCs simultaneously for backup purposes. In addition the gateway supports all common **VPN** protocols (OpenVPN, PPTP, IPSec) and can establish secured tunneling connection between clients.

**Cloud Platforms connection:** **IMG-4312-4G** supports all common lightweight Cloud communication protocols: **MQTT** (Message Queuing Telemetry Transport) including **Sparkplug B** version for payload and topic definition, **CoAP** (Constrained Application Protocol) and **LWM2M** (Lightweight M2M). It is fully compatible with ORing PaaS Cloud but it also makes the Gateway a universal and flexible solution for any existing Cloud Platform integration.

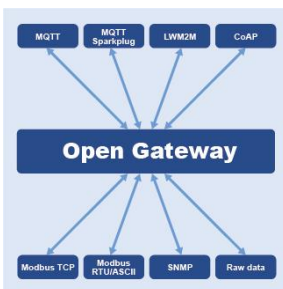

Thanks to ORing branded **Open Gateway** software feature it simplifies to maximum IoT solution deployment. Connecting big variety of end-devices, very often with different communication interfaces, to different Cloud Platforms has never been so easy. Open Gateway protocol converter from a very simple and user-friendly web-based configuration interface turns the gateway into a transparent man in the middle between Modbus field devices and MQTT/CoAP/LWM2M servers. The user has a possibility to define and shape the data format before it is sent to the Cloud for secured storing, analysis and Dashboard or HMI SCADA visualization.

## IoT Architecture

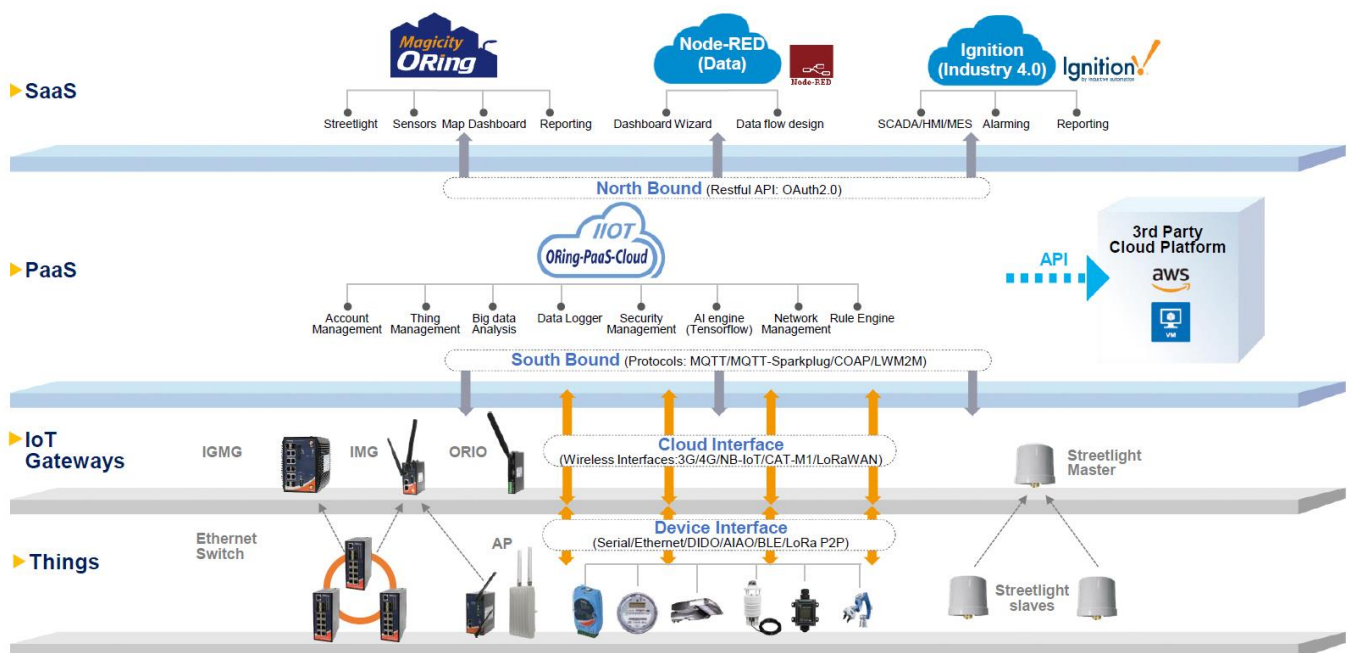

Above architecture picture shows typical application and use case scenario for ORing IoT system. IoT Gateways are responsible for providing transparent connectivity between end-devices and South Bound interface of the Cloud platform. Once the data reaches the Platform it can be stored securely and analyzed. Applications on the top of the system provide HMI and Dashboards for data visualization, reporting, alarming, historian and device location.

## Edge to Cloud Application

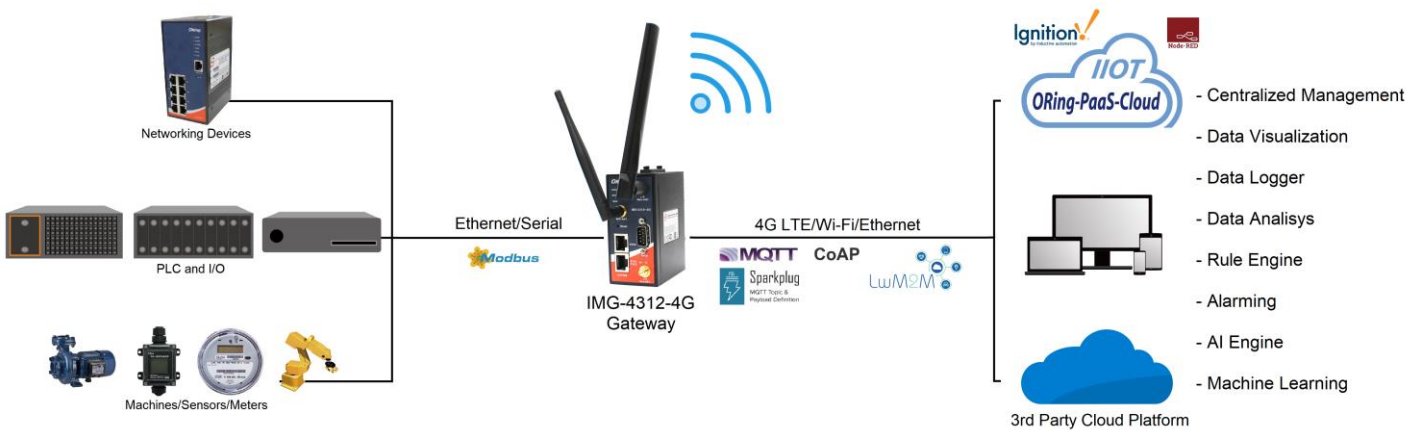

## VPN Remote Access Application

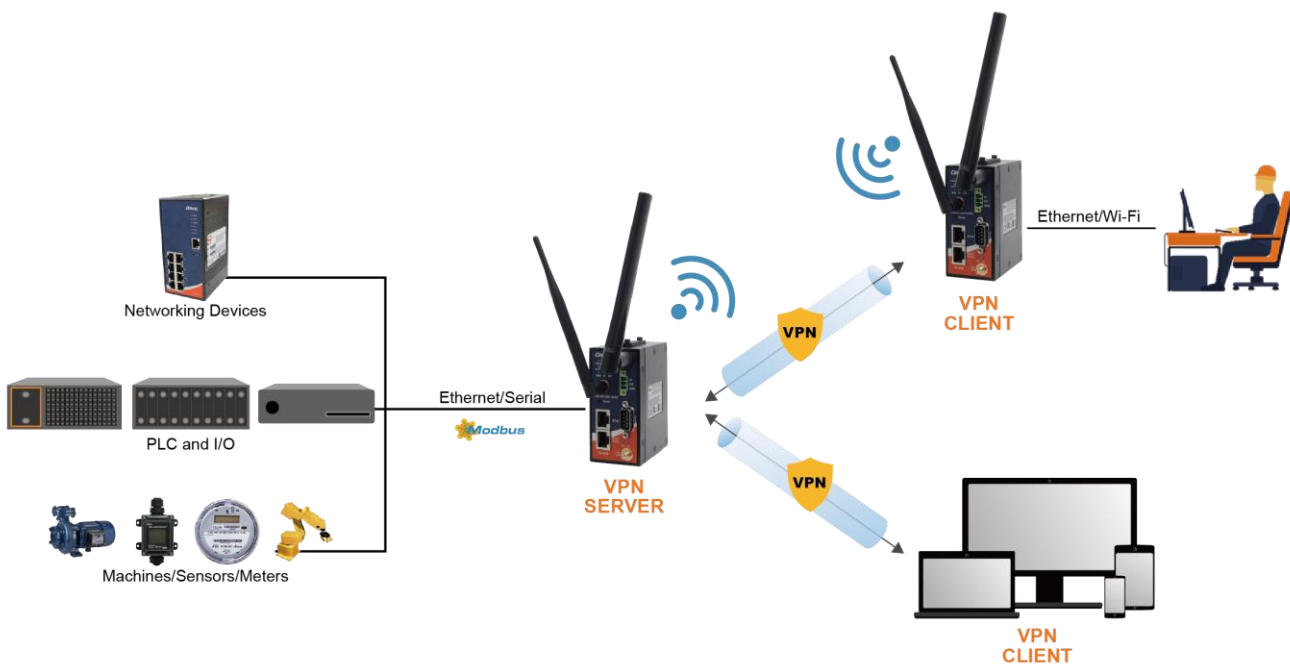

## Pin Definition

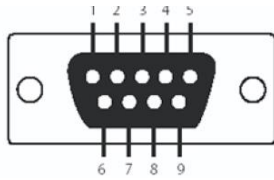

DB9 connector

Pin #	RS-232	RS-422	RS-485 ( 4 wire )	RS-485 ( 2 wire )
1	DCD	TX-	TX-	DATA -
2	RXD	TX+	TX+	DATA +
3	TXD	RX+	RX+	
4	DTR	RX-	RX-	
5	GND	GND	GND	
6	DSR			
7	RTS			
8	CTS			
9	RI			

## Dimension

Unit =mm (Tolerance ±0.5mm)

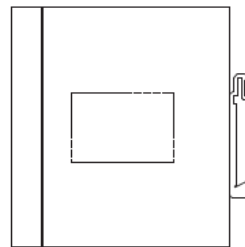
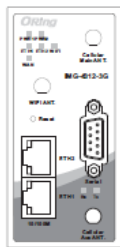
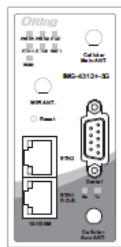
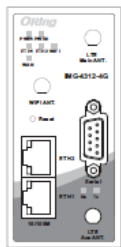
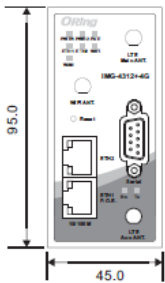
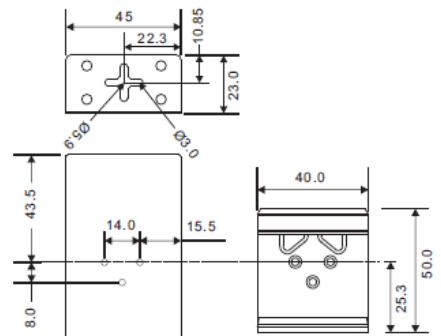
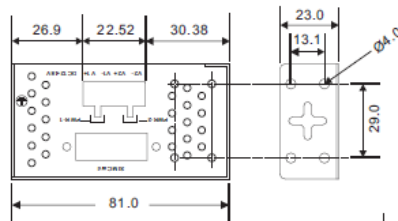

## Specifications

ORing M2M Gateway	IMG-4312-4G	IMG-4312+4G
<b>Physical Ports</b>		
10/100 Base-T(X) Ports in RJ45 Auto MDI/MDIX	2	
PoE P.D Port		P.O.E.Present at ETH1 Power Device (IEEE 802.3af): IEEE 802.3af compliant input interface Over load & short circuit protection Isolation Voltage: 1000 VDC min. Isolation Resistance : 10 <sup>8</sup> ohms min
Sim card slot	1	
<b>Cellular Interface</b>		
Antenna Connector	2 x SMA Female	
Cellular Standard	GSM / GPRS/ EGPRS/ EDGE / WCDMA / HSDPA / HSUPA / LTE	
Band Option	<p>America (US grade) LTE: FDD:1900(B2)/1700(B4)/850(B5)/700(B12)/700(B13)/700(B14)/1700(B66)/600(B71) MHz UMTS/HSDPA/HSUPA/HSPA+: 1900/1700/850 MHz</p> <p>Europe (EU grade) LTE: FDD:2100(B1)/1800(B3)/2600(B7)/900(B8)/800(B20) MHz TDD:TDD:2600(B38)/2300(B40)/2500(B41) MHz UMTS/HSDPA/HSUPA/HSPA+: 2100(B1)/900(B8) MHz GSM/GPRS/EDGE: 900/850 MHz</p> <p>Taiwan (TW grade) LTE: FDD:2100(B1)/1900(B2)/1800(B3)/1700(B4)/850(B5)/2600(B7)/900(B8)/700(B28) MHz TDD:2300(B40) UMTS/HSDPA/HSUPA/HSPA+/DC-HSPA+: 2100(B1)/1900(B2)/850(B5)/900(B8) MHz GSM/GPRS/EDGE: B2/B3/B5/B8</p> <p>China (CN grade) LTE: FDD:2100(B1)/1800(B3)/900(B8) MHz TDD:2600(B38)/1900(B39)/2300(B40)/2500(B41) MHz TDSCDMA: B34/B39 WCDMA: 900/2100 MHz CDMA 1x/EVDO: 800(BC0) MHz GSM: 900/1800 MHz</p>	
<b>WiFi Interface</b>		
Antenna Connector	1 x RP-SMA Female	
Modulation	IEEE802.11b: CCK/DQPSK/DBPSK IEEE802.11g: OFDM IEEE802.11n: BPSK, QPSK, 16-QAM, 64-QAM	
Frequency Band	America / FCC: 2.412~2.462 GHz (11 channels ) Europe CE / ETSI: 2.412~2.472 GHz ( 13 channels )	
Transmission Rate	802.11b: 1/2/5.5/11 Mbps 802.11g: 6/9/12/18/24/36/48/54 Mbps 802.11n(40MHz): UP to 150 Mbps	
Transmit Power	802.11b: 19dBm ±1.5dBm 802.11g: 17dBm ±1.5dBm	

	802.11n(2.4G@20MHz): 16dBm ±1.5dBm 802.11n(2.4G@40MHz): 14dBm ±1.5dBm	
Receiver Sensitivity	802.11b: -90dBm ±2dBm@1Mbps 802.11g: -72dBm ±2dBm@54Mbps 802.11n(2.4G@40MHz,MCS7): -68dBm ±2dBm	
Encryption Security	WEP: (64-bit ,128-bit key supported) WPA/WPA2 :802.11i(WEP and AES encryption) WPA-PSK (256-bit key pre-shared key supported) 802.1X Authentication supported TKIP encryption	
<b>Serial Ports</b>		
Connector	DB9 x 1	
Operation Mode	RS-232/422/485	
Serial Baud Rate	110 bps to 115.2 Kbps	
Data Bits	7, 8	
Parity	odd, even, none, mark, space	
Stop Bits	1, 1.5, 2	
RS-232	TxD, RxD, RTS, CTS, DTR, DSR, DCD, RI, GND	
Flow Control	XON/XOFF, RTS/CTS, DTR/DSR	
<b>Network Protocol</b>		
Protocol	ICMP, IP, TCP, UDP, DHCP, BOOTP, SSH, DNS, SNMP V1/V2c, HTTPS, SMTP, DDNS, PPPoE	
<b>LED Indicators</b>		
Power indicator	3 x LEDs, PWR 1(2)(PoE) / Ready: Green On: Power is on	
10/100TX RJ45 port indicator	2 x LEDs, Green for port Link/Act at 100Mbps.	
Serial TX / RX LEDs:	Red: Serial port is receiving data Green: Serial port is transmitting data	
WIFI LED	1 x LED, Green: WIFI Link /ACT	
WAN LED	1 x LED, Green On : Power is on and functioning Normal	
<b>Power</b>		
Redundant Input power	Dual DC inputs. 12-48VDC on 4-pin terminal block	
Power consumption (Typ.)	3W	3.5W
Overload current protection	Present	
Reverse polarity protection	Present on terminal block	
<b>Physical Characteristic</b>		
Enclosure	IP-30	
Dimension (W x D x H)	45(W)x80.6(D)x95(H) mm	
Weight (g)	368	372
<b>Environmental</b>		
Storage Temperature	-40 to 85°C (-40 to 185°F)	
Operating Temperature	-10 to 60°C (14 to 140°F)	
Operating Humidity	5% to 95% Non-condensing	
<b>Regulatory approvals</b>		
EMC	CE EMC (EN 55024, EN 55032), FCC Part 15 B	
EMI	EN 55032, CISPR32, EN 61000-3-2, EN 61000-3-3,FCC Part 15 B class A	
EMS	EN 55024 (IEC/EN 61000-4-2 (ESD), IEC/EN 61000-4-3 (RS), IEC/EN 61000-4-4 (EFT), IEC/EN 61000-4-5 (Surge), IEC/EN 61000-4-6 (CS), IEC/EN 61000-4-8 (PFMF), IEC/EN61000-4-11(DIP))	
Shock	IEC60068-2-27	
Free Fall	IEC60068-2-31	
Vibration	IEC60068-2-6	
Safety	UL60950-1 ; IEC60950-1 ;EN60950-1	
Hazardous Areas	ATEX, C1D2	

MTBF	483699.1813 hrs	203904.4494 hrs
<b>Warranty</b>	5 years	

## Packing List

---

- **IMG-4312-4G x 1**
- **Wall-Mount Kit x 1**
- **2.4G Wi-Fi antenna x 1**
- **CD x 1**
- **Din-Rail Kit x 1**
- **LTE antenna x 2**
- **Quick Installation Guide x 1**

## Optional Accessories

---

- **DR/SDR/DRP Series DIN-Rail power supply**