

# MLC

## Micro SATA III Flash Module

### HERMES-J Series

(SATA III Disk On Module)

**Document No. :** 100-xxMSF-JJCTMB

**Version No. :** 02V1

**Date :** May, 2023



ISO 9001 : 2015 CERTIFIED



### Product Features

#### ■ Flash IC

- KIOXIA 15nm NAND Flash IC.
- Multi-Level Cell (MLC) management

#### ■ Compatibility

- Compliant with SATA Revision 3.1
- SATA 1.5Gbps/3.0Gbps/6.0Gbps data transfer rate.

#### ■ Additional Capabilities

- S.M.A.R.T.\*<sup>1</sup> (Self-Monitoring, Analysis and Reporting Technology) feature set support.
- Native Command Queuing (NCQ) support.
- TRIM maintenance command support.
- Static wear-leveling algorithm
- Support bad Block Management

#### ■ Mechanical

- Standard 7 pins SATA female connector
- Optional built-in power pin as the 7th pin of 7pin header (w/fuse) or power input power cable (w/o fuse)
- Dimension:

Vertical Standard (VS)=18.0mm x 38.5mm /20.0g

Vertical Low Profile (VL)=30.1 mm x 28.7mm /20.0g

Horizontal Standard (HS)=18.0mm x 30.3mm /20.0g

Horizontal Low Profile (HL)=40.0mm x 30.0mm /20.0g

#### ■ Power Operating Voltage +5V(+/-) 5%

- Read Mode: 110.0 mA (max.)
- Write Mode: 125.0 mA (max.)
- Idle Mode: 90.0 mA (max.)

**(Option w/Fuse version that the host SATA Pin7**

**VCC @ 5V/1A power supply is requested)**

#### ■ Performance (Maximum value) \*<sup>2</sup>

- Sequential Read: 230.3 MB/sec. (max.)
- Sequential Write: 80.5 MB/sec. (max.)

#### ■ Capacity

- 4GB, 8GB, 16GB, 32GB, 64GB and 128GB.

#### ■ Reliability

- **TBW:** Up to 37.12 TBW at 128GB Capacity.  
(Client workload by JESD-219A)
- **ECC:** Automatic 40 bits per 1024 bytes error correction (ECC) and retry capabilities
- **Temperature:** (Operating)  
Standard Grade: 0°C ~ +70°C  
Wide Temp. Grade: -40°C ~ +85°C
- **Vibration:** 70 Hz to 2K Hz, 20G, 3 axes.
- **Shock:** 0.5ms, 1500 G, 3 axes

#### ■ Certifications and Declarations

- **Certifications:** CE & FCC
- **Declarations:** RoHS & REACH

#### Remarks:

1. Support official S.M.A.R.T. Utility.
2. Sequential performance is based on CrystalDiskMark 5.1.2 with file size 1000MB

### Order Information

#### I. Part Number List

##### ◆ APRO MLC Micro SATA III Flash Module – Vertical Standard Form Factor

Product Picture	Grade	Standard grade (0°C ~ 70°C)	Wide Temp Grade ( -40°C ~ +85°C )
	4GB	SBMSF004G-JJCTMB-VS(T/F)	WBMSF004G-JJCTMB-VS(T/F)C
	8GB	SBMSF008G-JJCTMB-VS(T/F)	WBMSF008G-JJCTMB-VS(T/F)C
	16GB	SBMSF016G-JJCTMB-VS(T/F)	WBMSF016G-JJCTMB-VS(T/F)C
	32GB	SBMSF032G-JJCTMB-VS(T/F)	WBMSF032G-JJCTMB-VS(T/F)C
	64GB	SBMSF064G-JJCTMB-VS(T/F)	WBMSF064G-JJCTMB-VS(T/F)C
	128GB	SBMSF128G-JJCTMB-VS(T/F)	WBMSF128G-JJCTMB-VS(T/F)C

##### ◆ APRO MLC Micro SATA III Flash Module – Vertical Low Profile Form Factor

Product Picture	Grade	Standard grade (0°C ~ 70°C)	Wide Temp Grade ( -40°C ~ +85°C )
	4GB	SBMSF004G-JJCTMB-VL(T/F)	WBMSF004G-JJCTMB-VL(T/F)C
	8GB	SBMSF008G-JJCTMB-VL(T/F)	WBMSF008G-JJCTMB-VL(T/F)C
	16GB	SBMSF016G-JJCTMB-VL(T/F)	WBMSF016G-JJCTMB-VL(T/F)C
	32GB	SBMSF032G-JJCTMB-VL(T/F)	WBMSF032G-JJCTMB-VL(T/F)C
	64GB	SBMSF064G-JJCTMB-VL(T/F)	WBMSF064G-JJCTMB-VL(T/F)C
	128GB	SBMSF128G-JJCTMB-VL(T/F)	WBMSF128G-JJCTMB-VL(T/F)C

##### ◆ APRO MLC Micro SATA III Flash Module – Horizontal Standard Form Factor

Product Picture	Grade	Standard grade (0°C ~ 70°C)	Wide Temp Grade ( -40°C ~ +85°C )
	4GB	SBMSF004G-JJCTMB-HS(T/F)	WBMSF004G-JJCTMB-HS(T/F)C
	8GB	SBMSF008G-JJCTMB-HS(T/F)	WBMSF008G-JJCTMB-HS(T/F)C
	16GB	SBMSF016G-JJCTMB-HS(T/F)	WBMSF016G-JJCTMB-HS(T/F)C
	32GB	SBMSF032G-JJCTMB-HS(T/F)	WBMSF032G-JJCTMB-HS(T/F)C
	64GB	SBMSF064G-JJCTMB-HS(T/F)	WBMSF064G-JJCTMB-HS(T/F)C
	128GB	SBMSF128G-JJCTMB-HS(T/F)	WBMSF128G-JJCTMB-HS(T/F)C

##### ◆ APRO MLC Micro SATA III Flash Module – Horizontal Low Profile Form Factor

Product Picture	Grade	Standard grade (0°C ~ 70°C)	Wide Temp Grade ( -40°C ~ +85°C )
	4GB	SBMSF004G-JJCTMB-HL(T/F)	WBMSF004G-JJCTMB-HL(T/F)C
	8GB	SBMSF008G-JJCTMB-HL(T/F)	WBMSF008G-JJCTMB-HL(T/F)C
	16GB	SBMSF016G-JJCTMB-HL(T/F)	WBMSF016G-JJCTMB-HL(T/F)C
	32GB	SBMSF032G-JJCTMB-HL(T/F)	WBMSF032G-JJCTMB-HL(T/F)C
	64GB	SBMSF064G-JJCTMB-HL(T/F)	WBMSF064G-JJCTMB-HL(T/F)C
	128GB	SBMSF128G-JJCTMB-HL(T/F)	WBMSF128G-JJCTMB-HL(T/F)C

#### Notes:

C: Special conformal coating treated on whole PCBA which may support industrial grade operating temperature -40°C ~ +85°C

### II. Part Number Decoder:

**X1 X2 X3 X4 X5 X6 X7 X8 X9** — **X11 X12 X13 X14 X15 X16** — **X18 X19 X20**

#### **X1** : Grade

**S** : Standard Grade – operating temp. 0° C ~ 70 ° C

**W** : Wide Temp Grade- operating temp. -40° C ~ +85 ° C

#### **X2** : The material of case

**B** : Bare

#### **X3 X4 X5** : Product category

**MSF** : Micro SATA Flash Module

#### **X6 X7 X8 X9** : Capacity

**004G:** 4GB      **032G:** 32GB

**008G:** 8GB      **064G** 64GB

**016G:** 16GB      **128G** 128GB

#### **X11** : Controller

**J** : HERMES Series

#### **X12** : Controller version

**A, B, C.....**

#### **X13** : Controller Grade

**C** : Commercial grade

#### **X14** : Flash IC

**T** : Kioxia MLC-NAND Flash IC

#### **X15** : Flash IC grade / Type

**M** : MLC-NAND Flash IC

#### **X16** : MLC Technology

**B** : Kioxia 15nm MLC

#### **X18 X19** MSF Orient Only

**VS** : Vertical Standard Form Factor

**VL** : Vertical Low Profile Form Factor

**HS** : Horizontal Standard Form Factor

**HL** : Horizontal Low Profile Form Factor

#### **X20** : Reserved for specific requirement

**Blank** : Standard product w/o thermal sensor and conformal-coating

**T** : Thermal Sensor (optional)

**F** : Power Pin-7 with fuse (optional)

**C** : Conformal coating (optional)

### **Revision History**

Revision	Description	Date
1.0	Initial release	2016/3/16
1.1	Add the option for thermal sensor	2018/11/02
1.2	Updated Version	2018/11/28
2.0	Updated document form	2019/06/12
2.1	Updated HL Type dimension	2023/05/23

### Contents

Product Features .....	- 2 -
Order Information .....	- 3 -
<b>I. Part Number List</b> .....	- 3 -
<b>II. Part Number Decoder:</b> .....	- 4 -
Revision History .....	- 5 -
Contents .....	- 6 -
<b>1. Introduction</b> .....	- 7 -
<b>1.1. Scope</b> .....	- 8 -
<b>1.2. Flash Management Technology – Static Wear Leveling</b> .....	- 8 -
<b>1.3. Bad Block Management</b> .....	- 8 -
<b>2. Product Specifications</b> .....	- 9 -
<b>2.1. System Environmental Specifications</b> .....	- 9 -
<b>2.2. System Power Requirements</b> .....	- 9 -
<b>2.3. System Performance</b> .....	- 9 -
<b>2.4. System Reliability</b> .....	- 10 -
<b>2.5. Physical Specifications</b> .....	- 11 -
<b>2.6. Conformal coating</b> .....	- 13 -
<b>3. Interface Description</b> .....	- 13 -
<b>3.1. Micro SATA III Flash Modules interface</b> .....	- 13 -
<b>3.2. Pin Assignments</b> .....	- 13 -
<b>Appendix A: Limited Warranty</b> .....	- 14 -

### 1. Introduction

APRO MLC Micro SATA III Flash Module HERMES-J Series provides high capacity flash memory Solid State Drive (SSD) that electrically complies with Serial ATA 3.0 (SATA) standard. APRO MLC Micro SATA III Flash Module HERMES-J Series support SATA 1.5Gbps/3.0Gbps/6.0Gbps data transfer rate with high performance. The main used flash memories are MLC-NAND type flash memory chips. The available disk capacities are 4GB, 8GB, 16GB, 32GB, 64GB and 128GB

The operating temperature grade is optional for Standard grade 0°C ~ 70°C and wide temp grade with conformal coating supports -40°C ~ +85°C. The data transfer performance by sequential read is up to 210.0 MB/sec, and sequential write is up to 80.0 MB/sec.

APRO MLC Micro SATA III Flash Module provides a high level interface to the host computer. This interface allows a host computer to issue commands to the MLC Micro SATA III Flash Module to read or write blocks of memory. Each sector is protected by a powerful 40 bits per 1024 bytes error correction (ECC). APRO MLC Micro SATA III Flash Module HERMES-J Series intelligent controller manages interface protocols, data storage and retrieval as well as ECC, defect handling and diagnostics, power management and clock control.

With the great flexibility to meet different SATA interface locations in systems, APRO MLC Micro SATA III Flash Module comes with optional form-factor in vertical type and horizontal type. And the power operating voltage supports 5V. Particularly it is built-in power pin as the 7th pin of 7pin header (w/fuse) or power input power cable (w/o fuse).

Figure 1 shows a block diagram of the used high tech MLC Micro SATA III Flash Module controller.

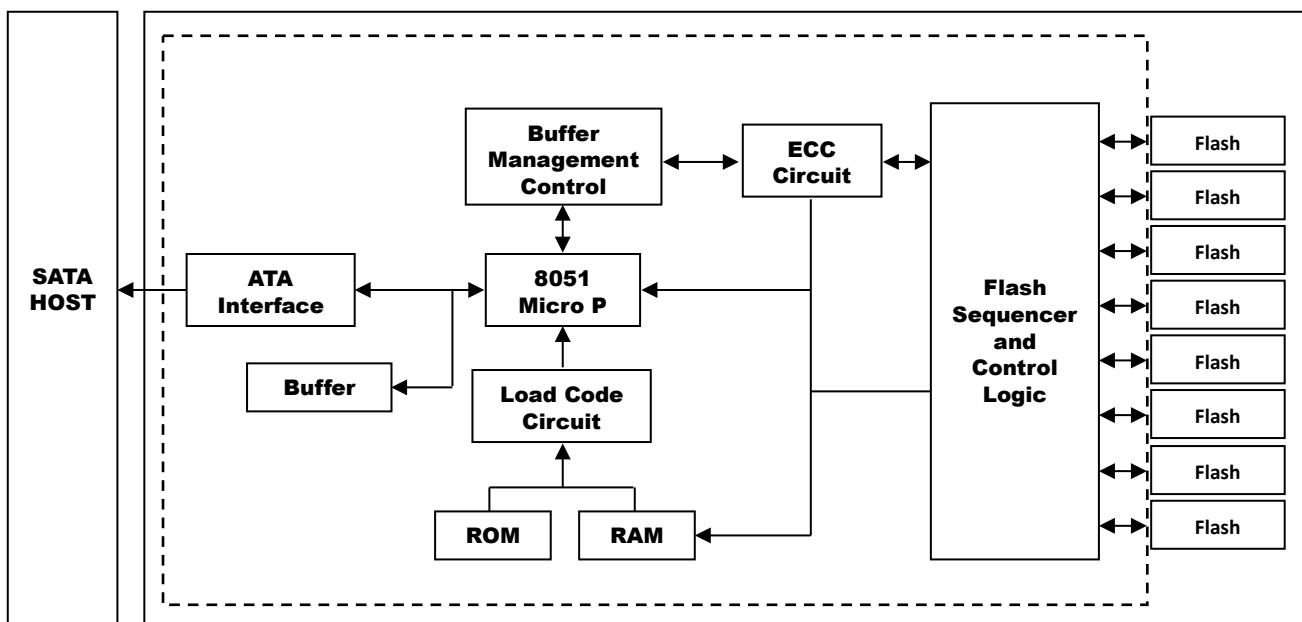

Figure 1: APRO MLC Micro SATA III Flash Module HERMES-J Series block diagram

### 1.1. Scope

This document describes features, specifications and installation guide of APRO MLC Micro SATA III Flash Module HERMES-J Series. In the appendix, there provides order information, warranty policy, RMA/DOA procedure for the most convenient reference.

### 1.2. Flash Management Technology – Static Wear Leveling

Flash memory can be programmed and erased within a limited number of times, and the limited of the P/E cycle is defined by the flash array vendor. The P/E cycle limited applies to each individual erase block in the flash device.

In order to gain the best management for flash memory, APRO MLC Micro SATA III Flash Module HERMES-J Series supports Static Wear-leveling technology to manage the Flash system. The life of flash memory is limited; the management is to increase the life of the flash product.

A static wear-leveling algorithm evenly distributes data over an entire Flash cell array and searches for the least used physical blocks. The identified low cycled sectors are used to write the data to those locations. If blocks are empty, the write occurs normally. If blocks contain static data, it moves that data to a more heavily used location before it moves the newly written data. The static wear leveling maximizes effective endurance Flash array compared to no wear leveling or dynamic wear leveling.

### 1.3. Bad Block Management

#### ➤ Early Bad Block

The fault block generated during the manufacturing process of NAND Flash is called Early Bad Block.

#### ➤ Later Bad Block

In the process of use, as the number of operations of writing and erasing increases, a fault block is gradually generated, which is called a Latter Bad Block.

**Bad block management** is a management mechanism for a bad block to be detected by the control IC and mark bad blocks in the NAND Flash and improve the reliability of data access. The bad block management mechanism of the control IC will establish a **Bad Block Table** when the NAND Flash is started for the first time, and will also record the errors found in the process of use in the bad block table, and data is ported to new valid blocks to avoid data loss.

In order to detect the initial bad blocks to handle run time bad blocks, APRO MLC Micro SATA III Flash Module HERMES-J Series provides the **Bad Block Management** scheme. It remaps a bad block to one of the reserved blocks so that the data contained in one bad block is not lost and new data writes on a bad block is avoided.



### 2. Product Specifications

For all the following specifications, values are defined at ambient temperature and nominal supply voltage unless otherwise stated.

#### 2.1. System Environmental Specifications

**Table 1: Environmental Specification**

APRO MLC Micro SATA III Flash Module		Standard Grade	Wide Temp Grade
HERMES-J Series		SBMSFxxxG-JJCTMB	WBMSFxxxG-JJCTMB/C
Temperature	Operating:	0°C ~ +70°C	-40°C ~ +85°C
	Non-operating:	-20°C ~ +80°C	-50°C ~ +95°C
Humidity	Operating & Non-operating:	10% ~ 95% non-condensing	
Vibration	Frequency/Acceleration:	70 Hz to 2K Hz, 20G, 3 axes	
Shock	Operating & Non-operating:	0.5ms, 1500 G, 3 axes	
Electrostatic Discharge (ESD)	Temperature:	24°C	
	Relative Humidity:	49% (RH)	
	+/-4KV:	Device functions are affected, but EUT will be back to its normal or operational state automatically.	

#### 2.2. System Power Requirements

**Table 2: Power Requirement**

APRO MLC Micro SATA III Flash Module HERMES-J Series		
DC Input Voltage (VCC)		5V±5%
Maximum average value	Reading Mode :	110.0 (max.)
	Writing Mode :	125.0 (max.)
	Idle Mode :	90.0 (max.)

**Table 3: Power Connector**

Pin No.	Connector	
Pin 1	Vcc 5V	
Pin 2	GND	

#### 2.3. System Performance

**Table 4: System Performances**

Data Transfer Mode supporting		Serial ATA Gen-III (6.0Gb/s = 768MB/s)					
Average Access Time		0.4 ms (estimated)					
Maximum Performance	Capacity	4GB	8GB	16GB	32GB	64GB	128GB
	Sequential Read (MB/s)	105.0	105.0	103.8	103.8	230.3	230.6
	Sequential Write(MB/s)	24.4	24.4	21.8	42.0	80.5	79.6

Note: The performance was measured using CrystalDiskMark by file size 1000MB (QD32).

### 2.4. System Reliability

**Table 5: System Reliability**

<b>Wear-leveling Algorithms</b>	Static wear-leveling algorithms
<b>Bad Blocks Management</b>	Supportive
<b>ECC Technology</b>	40 bits per 1024 bytes
<b>Thermal Sensor</b>	Supportive
<b>Erase counts</b>	NAND MLC Flash Cell Level : 3K P/E Cycles
<b>Capacity</b>	<b>TBW(TB)</b>
<b>4GB</b>	1.16
<b>8GB</b>	2.32
<b>16GB</b>	4.64
<b>32GB</b>	9.28
<b>64GB</b>	18.56
<b>128GB</b>	37.12





Note:

- Client workload by JESD-219A.
- The endurance of SSD could be varying based on user behavior, NAND endurance cycles, and write amplification factor. It is not guaranteed by flash vendor.

### 2.5. Physical Specifications

Refer to Table 6 and see Figure 2 for APRO MLC Micro SATA III Flash Module HERMES-J Series physical specifications and dimensions.

**Table 6: Form Factors**

Vertical Type Standard Form Factor (VS)	Vertical Type Low Profile Form Factor (VL)
	
Horizontal Type Standard Form Factor (HS)	Horizontal Type Low Profile Form Factor (HL)
	

**Table 7: Physical Specifications of APRO MLC Micro SATA III Flash Module-HERMES-J Series**

Form-factor	Width	Length	Weight
Vertical Type – Standard (VS)	18.00 mm	38.50 mm	20.00g
Vertical Type – Low Profile (VL)	30.10 mm	28.75 mm	20.00g
Horizontal Type – Standard (HS)	18.00 mm	30.30 mm	20.00g
Horizontal Type –Low Profile (HL)	40.00 mm	30.00 mm	20.00g

**Vertical Type - Standard Form-factor (VS)**

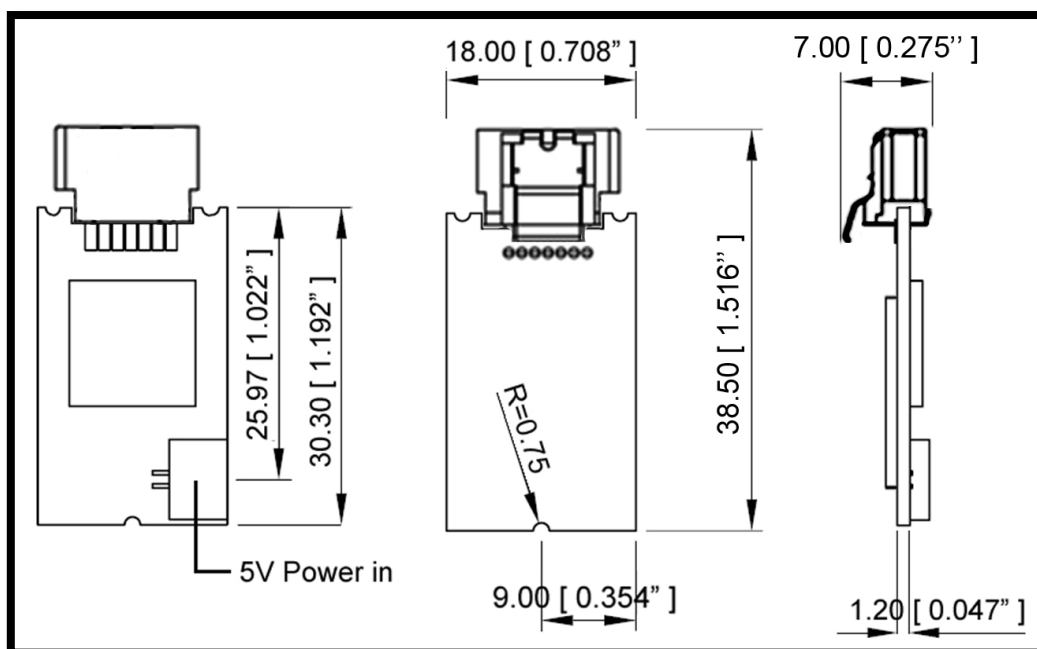

**Vertical Type - Low Profile Form-factor (VL)**

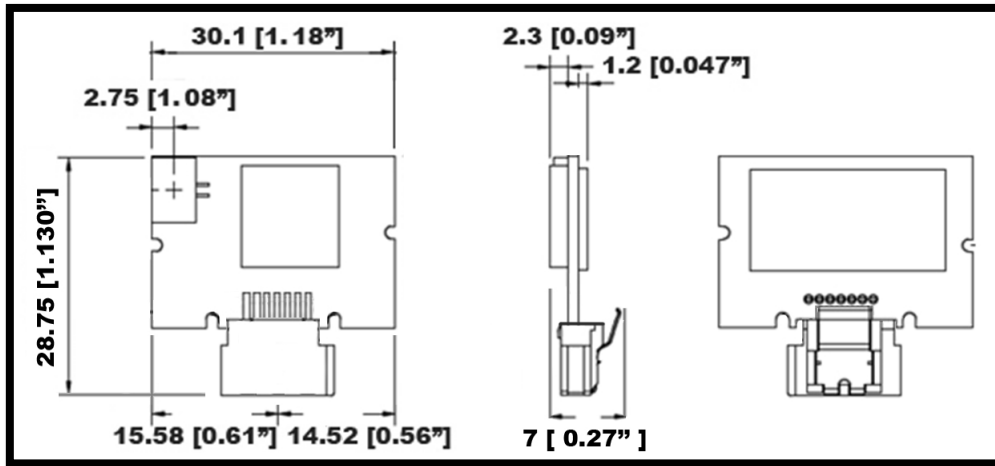

**Horizontal Type - Standard Form-factor (HS)**

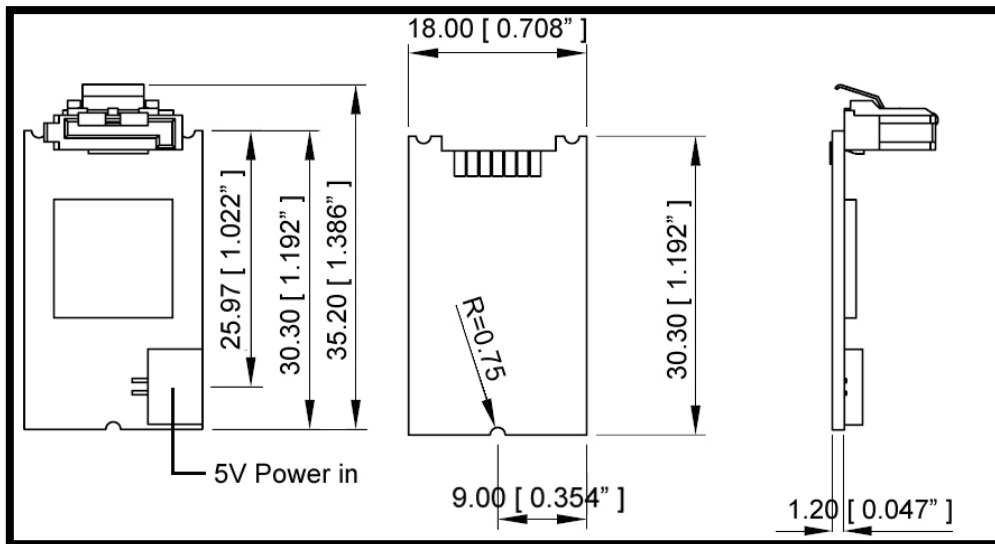

**Horizontal Type - Low Profile Form-factor (HL)**

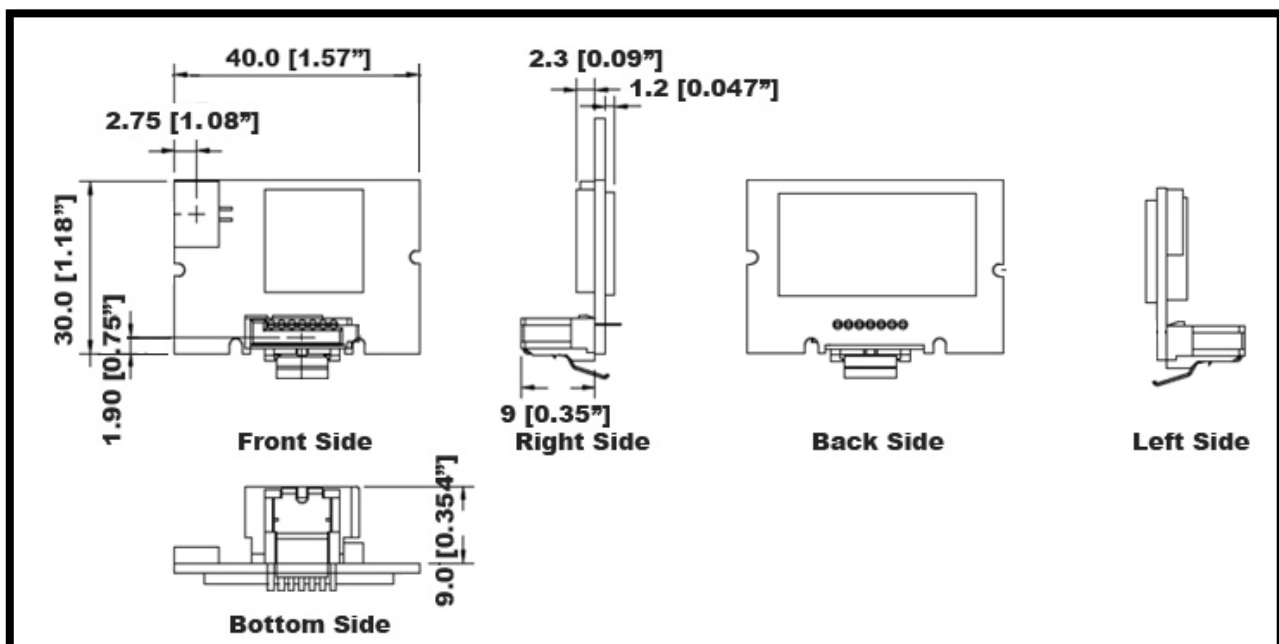

**Figure 2: APRO MLC Micro SATA III Flash Module HERMES-J Series Dimension**

### 2.6. Conformal coating

Conformal coating is a protective, dielectric coating designed to conform to the surface of an assembled printed circuit board. Commonly used conformal coatings include silicone, acrylic, urethane and epoxy. APRO applies only silicone on APRO storage products upon requested especially by customers. The type of silicone coating features good thermal shock resistance due to flexibility. It is also easy to apply and repair.

Conformal coating offers protection of circuitry from moisture, fungus, dust and corrosion caused by extreme environments. It also prevents damage from those Flash storages handling during construction, installation and use, and reduces mechanical stress on components and protects from thermal shock. The greatest advantage of conformal coating is to allow greater component density due to increased dielectric strength between conductors.

APRO use MIL-I-46058C silicon conformal coating

## 3. Interface Description

### 3.1. Micro SATA III Flash Modules interface

APRO MLC Micro SATA III Flash Modules HERMES-J Series follow standard SATA 1.0a with 7-pin signal segment. The interface is 7-pin female connector. There are 2 solutions for customer's requirement. If customer's motherboard design in SATA interface pin-7 with 5V power output, there is a solution which has built-in power pin as the 7th pin of 7 pins header (w/fuse) , or another solution w/o fuse and for connection via cable.

Figure 3 is the aspect of the connector of micro SATA II Flash Module.

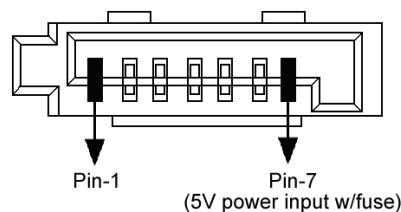

**Figure 3: The connectors of micro SATA III Flash Module HERMES-J Series**

### 3.2. Pin Assignments

Refer to Table 8 for APRO MLC Micro SATA III Flash Module HERMES-J Series pin assignments. There are total of 7 pins in the signal segment.

**Table 8 - Pin Assignments**

Name	Type	Description
S1	GND	Shielding
S2	A+	Differential Signal Pair A
S3	A-	
S4	GND	Shielding
S5	B-	Differential Signal Pair B
S6	B+	
S7	GND	Shielding/Power

### **Appendix A: Limited Warranty**

APRO warrants your Micro SATA III Flash Modules against defects in material and workmanship for the life of the drive. The warranty is void in the case of misuse, accident, alteration, improper installation, misapplication or the result of unauthorized service or repair. The implied warranties of merchantability and fitness for a particular purpose, and all other warranties, expressed or implied, except as set forth in this warranty, shall not apply to the products delivered. In no event shall APRO be liable for any lost profits, lost savings or other incidental or consequential damages arising out of the use of, or inability to use, this product.

**BEFORE RETURNING PRODUCT, A RETURN MATERIAL AUTHORIZATION (RMA) MUST BE OBTAINED FROM APRO.**

Product shall be returned to APRO with shipping prepaid. If the product fails to conform based on customers' purchasing orders, APRO will reimburse customers for the transportation charges incurred.

#### **WARRANTY PERIOD:**

- **MLC ( Standard grade / Wide temp. grade )    2 years / Within 3K Erasing Counts**

This document is for information use only and is **subject to change without prior notice**. APRO Co., Ltd. assumes no responsibility for any errors that may appear in this document, nor for incidental or consequential damages resulting from the furnishing, performance or use of this material. No part of this document may be reproduced, transmitted, transcribed, stored in a retrievable manner or translated into any language or computer language, in any form or by any means, electronic, mechanical, magnetic, optical, chemical, manual or otherwise, without the prior written consent of an officer of APRO Co., Ltd.

All parts of the APRO documentation are protected by copyright law and all rights are reserved.

APRO and the APRO logo are registered trademarks of APRO Co., Ltd.

Product names mentioned herein are for identification purposes only and may be trademarks and/or registered trademarks of their respective companies.

© 2023 APRO Corporation. All rights reserved