

Industrial  
DDR3L SODIMM  
Datasheet

廣穎電通股份有限公司  
Silicon Power Computer & Communications Inc.  
TEL: 886-2 8797-8833 FAX: 886-2 8751-6595  
台北市114內湖區洲子街106號7樓  
7F, No.106, ZHO-Z ST. NEIHU DIST, 114, TAIPEI, TAIWAN,

## RESTRICTIONS OF DATASHEET USE

- This document is proprietary, confidential and intended solely for the recipient. No part of this document may be disclosed in any manner to a third party or reproduced without the prior written consent of Silicon Power. No implied, by estoppel or otherwise, to any intellectual property rights is granted by this document.
- Except as provided in any term and conditions, and/or any agreements in written by Silicon Power, Silicon Power assumes no responsibility whatever, including but not limited to, indirect, consequential, special, punitive, incidental damages, loss, loss of profits, loss of opportunities, business interruption and data. Silicon Power disclaims any express or implies warranty and conditions related to sale, use of product, or information, including warranty or conditions of merchantability, fitness for a particular purpose, accuracy of information or non-infringement.
- Moreover, Silicon Power may reserve the right to make change to the information of this document at any time without notice.

© 2016 Silicon Power Computer & Communications Inc.. All rights reserved.



SP Silicon  
Power  
CONFIDENTIAL

## Index

RESTRICTIONS OF DATASHEET USE .....	2
Index.....	3
Revision History .....	4
Description .....	5
Features .....	6
DDR3L Industrial SLU Module Specification .....	6
Pin Assignments .....	7
Pin Description .....	8
Environmental Requirements.....	9
Absolute Maximum DC Ratings .....	9
Operating temperature Conditions .....	10
DC Electrical Characteristics and Operating Conditions .....	10
Single-Ended AC and DC Input Levels for Command and Address .....	11
Single-Ended AC and DC Input Levels for DQ and DM .....	11
Block Diagram(x8 1Rank).....	12
Block Diagram(x8 2Ranks).....	13
Block Diagram(x16 1Rank).....	14
Block Diagram(x16 2Ranks).....	15
Simplified Mechanical Drawing(x8 1Rank).....	16
Simplified Mechanical Drawing(x8 2Ranks).....	17
Simplified Mechanical Drawing(x16 1Rank).....	18
Simplified Mechanical Drawing(x16 2Ranks).....	19

## Revision History

Revision No.	Date	Remarks
1.0	2016/10/18	First release
1.1	2017/12	Modify description.
1.2	2018/3	Add 256Mx8 Single Rank.



## Description

The Silicon Power Computer & Communications industrial DDR3L SLU series products are 204-Pin Double Data Rate 3 (DDR3) Synchronous DRAM Small Outline Dual In-Line Memory Module (SODIMM), organized as a one rank 512Mx64, high-speed memory array or two ranks 1024Mx64 high-speed memory array, The module uses four 256x16 (2GB) eight 256Mx8(2GB), 512Mx8 (4GB), sixteen 512Mx8 (8GB) DDR3 SDRAMs in BGA packages

This DIMM are manufactured using raw cards developed for broad industry use as reference designs. The use of these common design files minimizes electrical variation between suppliers.

DDR3 SDRAM DIMM provide a high-performance, flexible 8-byte interface in a space-saving footprint.

The DIMM is intended for use in applications operating of 800MHz clock speeds and achieves high-speed data transfer rates of 1600Mbps. Prior to any access operation, the device CAS latency and burst/length/operation type must be programmed into the DIMM by address inputs A0-A13(128Mx8 or 128Mx16), A0-A14(256Mx8 or 256Mx16), A0-A15 (512Mx8) and I/O inputs BA0~BA2 using the mode register set cycle.

The DIMM uses serial presence-detect implemented via a serial EEPROM using a standard IIC protocol.

**CONFIDENTIAL**

## Features

- DDR3(L) functionality and operations supported as defined in the component data sheet
- 204pin, small-outline dual in-line memory module (SODIMM)
- Fast data transfer rates:  
DDR3L-1600(PC3L-12800)
- Single or Dual rank
- 2GB (256 Meg x 64), 4GB (512Meg x 64), 8GB (1Giga x 64)
- DDR3L Low Power  $V_{DD} = V_{DDQ} = 1.35V (+0.1\sim-0.067V)$
- $V_{DDSPD} = 3.0V$  to  $3.6V$
- Reset pin for improved system stability
- Nominal and dynamic on-die termination (ODT) for data, strobe, and mask signals
- Fixed burst chop (BC) of 4 and burst length (BL) of 8 via the mode register set (MRS)
- Adjustable data-output drive strength
- Fly-by topology
- Terminated control, command, and address bus
- Serial presence-detect (SPD) EEPROM
- Gold edge contacts
- Pb-free

## DDR3L Industrial SLU Module Specification

Part Number	Module Density & Configuration	Bandwidth	Data Rate	Timing	Operator Voltage
				(tCL-tRCD-tRP)	
SP002GISLU160VS0	2GB (256Mx64) 256Mx8 1Rank	PC3L-12800	DDR3L-1600	11-11-11	1.35V
SP002GISLU160WH0	2GB (256Mx64) 256Mx16 1Rank	PC3L-12800	DDR3L-1600	11-11-11	1.35V
SP004GISLU160NH0	4GB (512Mx64) 512Mx8 1Rank	PC3L-12800	DDR3L-1600	11-11-11	1.35V
SP008GISLU160NH0	8GB (1Gx64) 512Mx8 2Ranks	PC3L-12800	DDR3L-1600	11-11-11	1.35V

Note:

1. This document supports all industrial SLU Series DDR3L 204Pin SODIMM products.

## Pin Assignments

204-Pin DDR3 SODIMM Front

Pin	Symbol	Pin	Symbol	Pin	Symbol	Pin	Symbol
1	VREFDQ	53	DQ19	105	VDD	157	DQ42
3	VSS	55	VSS	107	A10	159	DQ43
5	DQ0	57	DQ24	109	BA0	161	VSS
7	DQ1	59	DQ25	111	VDD	163	DQ48
9	VSS	61	VSS	113	WE#	165	DQ49
11	DM0	63	DM3	115	CAS#	167	VSS
13	VSS	65	VSS	117	VDD	169	DQS6#
15	DQ2	67	DQ26	119	A13	171	DQS6
17	DQ3	69	DQ27	121	S1#	173	VSS
19	VSS	71	VSS	123	VDD	175	DQ50
21	DQ8	73	CKE0	125	NC	177	DQ51
23	DQ9	75	VDD	127	VSS	179	VSS
25	VSS	77	NC	129	DQ32	181	DQ56
27	DQS1#	79	BA2	131	DQ33	183	DQ57
29	DQS1	81	VDD	133	VSS	185	VSS
31	VSS	83	A12	135	DQS4#	187	DM7
33	DQ10	85	A9	137	DQS4	189	VSS
35	DQ11	87	VDD	139	VSS	191	DQ58
37	VSS	89	A8	141	DQ34	193	DQ59
39	DQ16	91	A5	143	DQ35	195	VSS
41	DQ17	93	VDD	145	VSS	197	SA0
43	VSS	95	A3	147	DQ40	199	VDDSPD
45	DQS2#	97	A1	149	DQ41	201	SA1
47	DQS2	99	VDD	151	VSS	203	VTT
49	VSS	101	CK0	153	DM5	-	-
51	DQ18	103	CK0#	155	VSS	-	-

204-Pin DDR3 SODIMM Back

Pin	Symbol	Pin	Symbol	Pin	Symbol	Pin	Symbol
2	VSS	54	VSS	106	VDD	158	DQ46
4	DQ4	56	DQ28	108	BA1	160	DQ47
6	DQ5	58	DQ29	110	RAS#	162	VSS
8	VSS	60	VSS	112	VDD	164	DQ52
10	DQS0#	62	DQS3#	114	S0#	166	DQ53
12	DQS0	64	DQS3	116	ODT0	168	VSS
14	VSS	66	VSS	118	VDD	170	DM6
16	DQ6	68	DQ30	120	ODT1	172	VSS
18	DQ7	70	DQ31	122	NC	174	DQ54
20	VSS	72	VSS	124	VDD	176	DQ55
22	DQ12	74	CKE1	126	VREFCA	178	VSS
24	DQ13	76	VDD	128	SS	180	DQ60
26	VSS	78	NC	130	DQ36	182	DQ61
28	DM1	80	NC/A14	132	DQ37	184	VSS
30	RESET#	82	VDD	134	VSS	186	DQS7#
32	VSS	84	A11	136	DM4	188	DQS7
34	DQ14	86	A7	138	VSS	190	VSS
36	DQ15	88	VDD	140	DQ38	192	DQ62
38	VSS	90	A6	142	DQ39	194	DQ63
40	DQ20	92	A4	144	VSS	196	VSS
42	DQ21	94	VDD	146	DQ44	198	EVENT#
44	VSS	96	A2	148	DQ45	200	SDA
46	DM2	98	A0	150	VSS	202	SCL
48	VSS	100	VDD	152	DQS5#	204	VTT
50	DQ22	102	CK1	154	DQS5	-	-
52	DQ23	104	CK1#	156	VSS	-	-

CONFIDENTIAL

## Pin Description

Symbol	Type	Description
A0–A15	Input	<b>Address inputs:</b> Provide the row address for ACTIVE commands and the column address and auto precharge bit for READ/WRITE commands to select one location out of the memory array in the respective bank. A10 is sampled during a PRECHARGE command to determine whether the PRECHARGE applies to one bank (A10 LOW) or all banks (A10 HIGH). If only one bank is to be precharged, the bank is selected by BA. A12 is sampled during READ and WRITE commands to determine if burst chop (on-the-fly) will be performed. The address inputs also provide the opcode during mode register command set. A0–A13 (128Mx8, 128Mx16) A0–A14 (256Mx8, 256Mx16) A0–A15 (512Mx8).
BA0–BA2	Input	<b>Bank address inputs:</b> BA0, BA1 define to which device bank an ACTIVE, READ, WRITE, or PRECHARGE command is being applied. BA0, BA1 define which mode register, including MR, EMR, EMR(2), and EMR(3), is loaded during the LOAD MODE command.
CK0, CK0#, CK1, CK1#	Input	<b>Clock:</b> CK and CK# are differential clock inputs. All address and control input signals are sampled on the crossing of the positive edge of CK and negative edge of CK#. Output data (DQs and DQS/DQS#) is referenced to the crossings of CK and CK#.
CKE0, CEK1	Input	<b>Clock enable:</b> CEK (registered HIGH) activates and CEK (registered LOW) deactivates clocking circuitry on the DDR3 SDRAM.
DM0–DM7	Input	<b>Data input mask:</b> DM is an input mask signal for write data. Input data is masked when DM is sampled HIGH, along with that input data, during a write access. DM is sampled on both edges of DQS. Although DM pins are input-only, the DM loading is designed to match that of DQ and DQS7pins.
ODT0 ODT1	Input	<b>On-die termination:</b> ODT (registered HIGH) enables termination resistance internal to the DDR3 SDRAM. When enabled, ODT is only applied to the following pins: DQ, DQS, DQS# and DM. The ODT input will be ignored if disabled via the LOAD MODE command.
RAS#, CAS#, WE#	Input	<b>Command inputs:</b> RAS#, CAS#, and WE# (along with S#) define the command being entered.
RESET#	Input (LVCMOS)	<b>Reset:</b> RESET# is an active LOW CMOS input referenced to V <sub>SS</sub> . The RESET# input receiver is a CMOS input defined as a rail-to-rail signal with DC HIGH $\geq 0.8 \times V_{DD}$ and DC LOW $\leq 0.2 \times V_{DD}$ .
S0#, S1#	Input	<b>Chip select:</b> S# enables (registered LOW) and disables (registered HIGH) the command decoder.
SA[2:0]	Input	<b>Presence-detect address inputs:</b> These pins are used to configure the SPD EEPROM address range.
SCL	Input	<b>Serial clock for presence-detect:</b> SCL is used to synchronize the presence-detect data transfer to and from the module.
DQ0–DQ63	I/O	<b>Data input/output:</b> Bidirectional data bus.
DQS0–DQS7 DQS0#–DQS7#	I/O	<b>Data strobe:</b> Output with read data, input with write data for source synchronous operation. Edge-aligned with read data, center-aligned with write data.
SDA	I/O	<b>Serial presence-detect data:</b> SDA is a bidirectional pin used to transfer addresses and data into and out of the SPD EEPROM on the module.
V <sub>DD</sub>	Supply	<b>Power supply:</b> 1.35V (+0.1~0.067V). The component V <sub>DD</sub> and V <sub>DDQ</sub> are connected to the module V <sub>DD</sub> .
V <sub>DDSPD</sub>	Supply	<b>Temperature sensor/SPD EEPROM power supply:</b> +3.0V to +3.6V.
V <sub>REFCA</sub>	Supply	<b>Reference voltage:</b> Control, command, and address (V <sub>DD</sub> /2).
V <sub>REFDQ</sub>	Supply	<b>Reference voltage:</b> DQ, DM (V <sub>DD</sub> /2).
V <sub>SS</sub>	Supply	Ground.
V <sub>TT</sub>	Supply	<b>Termination voltage:</b> Used for control, command, and address (V <sub>DD</sub> /2).
NC	–	<b>No connect:</b> These pins are not connected on the module.
NU	–	<b>Not used:</b> These pins are not used in specific module configuration/operations.



## Environmental Requirements

Symbol	Parameter	Rating	Units	Note
$T_{OPR}$	Module Operating Temperature Range (ambient)	0 to 55	°C	3
$H_{OPR}$	Operating Humidity (relative)	10 to 90	%	1
$T_{STG}$	Storage Temperature (Plastic)	-55 to 100	°C	1
$H_{STG}$	Storage Humidity (without condensation)	5 to 95	%	1
$P_{BAR}$	Barometric Pressure (operating & storage)	105 to 69	K Pascal	1, 2

Note:

- Stresses greater than those listed may cause permanent damage to the device. This is a stress rating only and device functional operation at or above the conditions indicated is not implied. Exposure to absolute maximum rating conditions for extended periods may affect reliability.
- Up to 9850 ft.
- The component maximum case temperature shall not exceed the value specified in the component spec.

## Absolute Maximum DC Ratings

Symbol	Parameter	Rating	Units	Note
$V_{DD}$	Voltage on $V_{DD}$ pins relative to $V_{SS}$	-0.4 V ~ 1.975 V	V	1, 3
$V_{DDQ}$	Voltage on $V_{DDQ}$ pins relative to $V_{SS}$	-0.4 V ~ 1.975 V	V	1, 3
$V_{IN}, V_{OUT}$	Voltage on I/O pins relative to $V_{SS}$	-0.4 V ~ 1.975 V	V	1
$T_{STG}$	Storage Temperature	-55 to +100	°C	1, 2

Note:

- Stresses greater than those listed under "Absolute Maximum Ratings" may cause permanent damage to the device. This is a stress rating only and functional operation of the device at these or any other conditions above those indicated in the operational sections of this specification is not implied. Exposure to absolute maximum rating conditions for extended periods may affect reliability.
- Storage Temperature is the case surface temperature on the center/top side of the DRAM.
- $V_{DD}$  and  $V_{DDQ}$  must be within 300 mV of each other at all times; and  $V_{REF}$  must be not greater

## Operating temperature Conditions

Symbol	Parameter	Rating	Units	Note
$T_{OPER}$	Normal Operating Temperature Range	0 to 85	°C	1, 2
	Extended Temperature Range (Optional)	85 to 95	°C	1, 3

Note:

- Operating Temperature  $T_{OPER}$  is the case surface temperature on the center / top side of the DRAM.
- The Normal Temperature Range specifies the temperatures where all DRAM specifications will be supported. During operation, the DRAM case temperature must be maintained between 0 to 85 °C under all operating conditions
- Some applications require operation of the DRAM in the Extended Temperature Range between 85 °C and 95 °C case temperature. Full specifications are supported in this range, but the following additional conditions apply:
  - Refresh commands must be doubled in frequency, therefore reducing the Refresh interval tREFI to 3.9  $\mu$ s. It is also possible to specify a component with 1X refresh (tREFI to 7.8 $\mu$ s) in the Extended Temperature Range. Please refer to supplier data sheet and/or the DIMM SPD for option availability.
  - If Self-Refresh operation is required in the Extended Temperature Range, then it is mandatory to either use the Manual Self-Refresh mode with Extended Temperature Range capability (MR2 A6 = 0b and MR2 A7 = 1b) or enable the optional Auto Self-Refresh mode (MR2 A6 = 1b and MR2 A7 = 0b). Please refer to the supplier data sheet and/or the DIMM SPD for Auto Self-Refresh option availability, Extended Temperature Range support and tREFI requirements in the Extended Temperature Range.

## DC Electrical Characteristics and Operating Conditions

Symbol	Parameter	Min	Typ	Max	Units	Notes
$V_{DD}$	Supply Voltage	1.283	1.35	1.45	V	1,2
$V_{DDQ}$	Output Supply Voltage	1.283	1.35	1.45	V	1,2

Note:

- Under all conditions  $V_{DDQ}$  must be less than or equal to  $V_{DD}$ .
- $V_{DDQ}$  tracks with  $V_{DD}$ . AC parameters are measured with  $V_{DD}$  and  $V_{DDQ}$  tied together.

## Single-Ended AC and DC Input Levels for Command and Address

Symbol	Parameter	DDR3-1066		DDR3-1333/DDR3-1600		Units	Note
		Min.	Max.	Min.	Max.		
VIH.CA(DC)	DC Input Logic High	Vref + 0.100	VDD	Vref + 0.100	VDD	V	1
VIL.CA(DC)	DC Input Logic Low	VSS	Vref - 0.100	VSS	Vref - 0.100	V	1
VIH.CA(AC)	AC Input Logic High	Vref + 0.175	Note 2	Vref + 0.175	Note 2	V	1, 2
VIL.CA(AC)	AC Input Logic Low	Note 2	Vref - 0.175	Note 2	Vref - 0.175	V	1, 2
VIH.CA(AC150)	AC Input Logic High	-	-	Vref + 0.15	Note 2	V	1, 2
VIL.CA(AC150)	AC Input Logic Low	-	-	Note 2	Vref - 0.15	V	1, 2
VRefCA(DC)	Reference Voltage for ADD, CMD Inputs	0.49 x VDD	0.51 x VDD	0.49 x VDD	0.51 x VDD	V	3, 4

Note:

1. For input only pins except . Vref = VrefCA(DC).
2. See "Overshoot and Undershoot Specifications" in the device datasheet.
3. The ac peak noise on VRef may not allow VRef to deviate from VRefDQ(DC) by more than +/-1% VDD (for reference: approx. +/- 15 mV).
4. For reference: approx. VDD/2 +/- 15 mV.

## Single-Ended AC and DC Input Levels for DQ and DM

Symbol	Parameter	DDR3-1066		DDR3-1333/DDR3-1600		Units	Note
		Min.	Max.	Min.	Max.		
VIH.DQ(DC)	DC Input Logic High	Vref + 0.100	VDD	Vref + 0.100	VDD	V	1
VIL.DQ(DC)	DC Input Logic Low	VSS	Vref - 0.100	VSS	Vref - 0.100	V	1
VIH.DQ(AC)	AC Input Logic High	Vref + 0.175	Note 2	Vref + 0.15	Note 2	V	1, 2, 5
VIL.DQ(AC)	AC Input Logic Low	Note 2	Vref - 0.175	Note 2	Vref - 0.15	V	1, 2, 5
VRefDQ(DC)	Reference Voltage for DQ, DM Inputs	0.49 x VDD	0.51 x VDD	0.49 x VDD	0.51 x VDD	V	3, 4

Note: 1. For input only pins except. Vref = VrefDQ(DC).

2. See "Overshoot and Undershoot Specifications" in the device datasheet.
3. The ac peak noise on VRef may not allow VRef to deviate from VRefDQ(DC) by more than +/-1% VDD (for reference: approx. +/- 15 mV).
4. For reference: approx. VDD/2 +/- 15 mV.
5. Single-ended swing requirement for DQS, DQS# is 350 mV (peak to peak). Differential swing requirement for DQS - DQS# is 700 mV(peak to peak).

### Block Diagram(x8 1Rank)

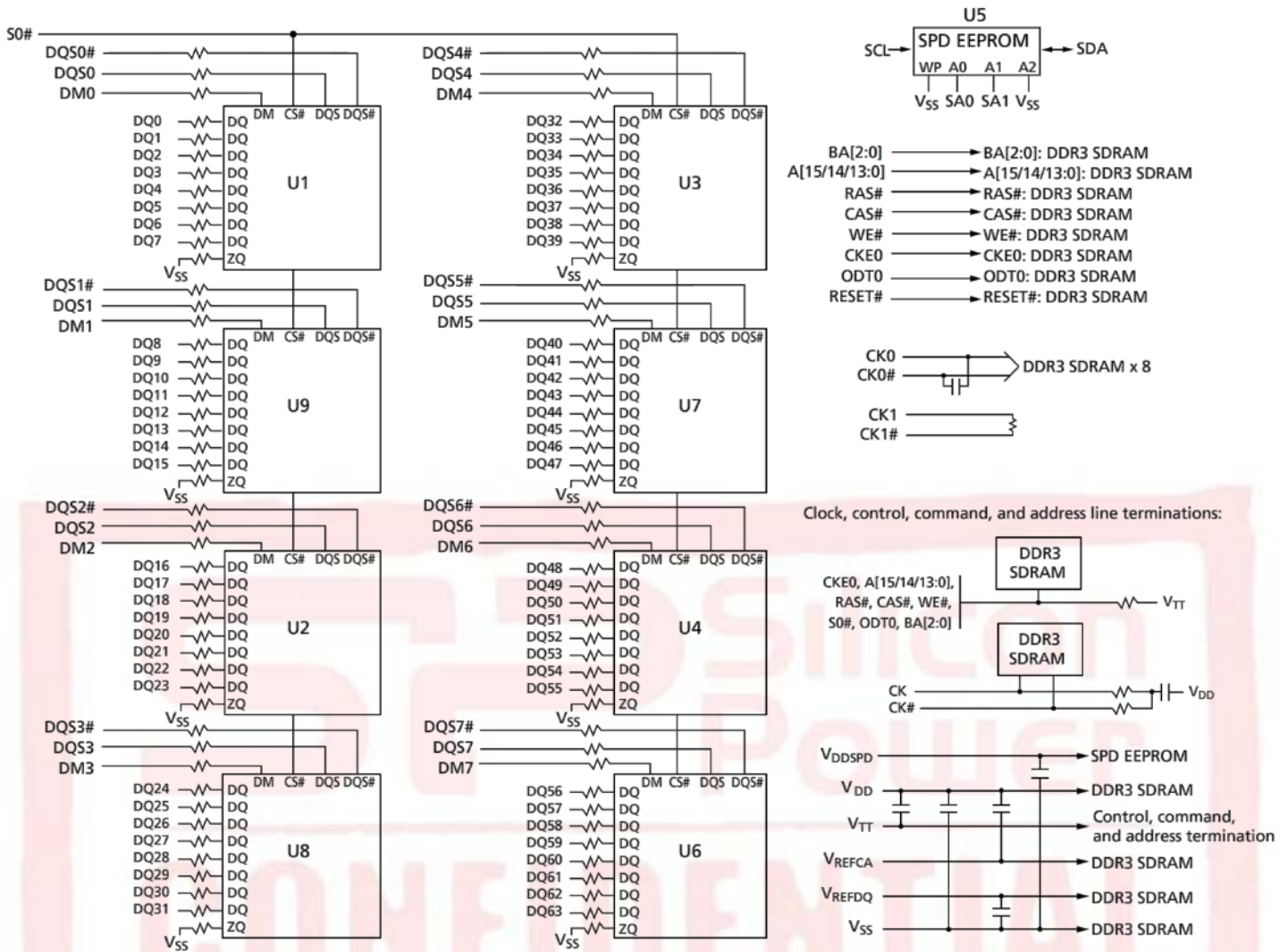

**Note:** The ZQ ball on each DDR3 component is connected to an external 240Ω resistor that is tied to ground. It is used for the calibration of the component's ODT and output driver.

## Block Diagram(x8 2Ranks)

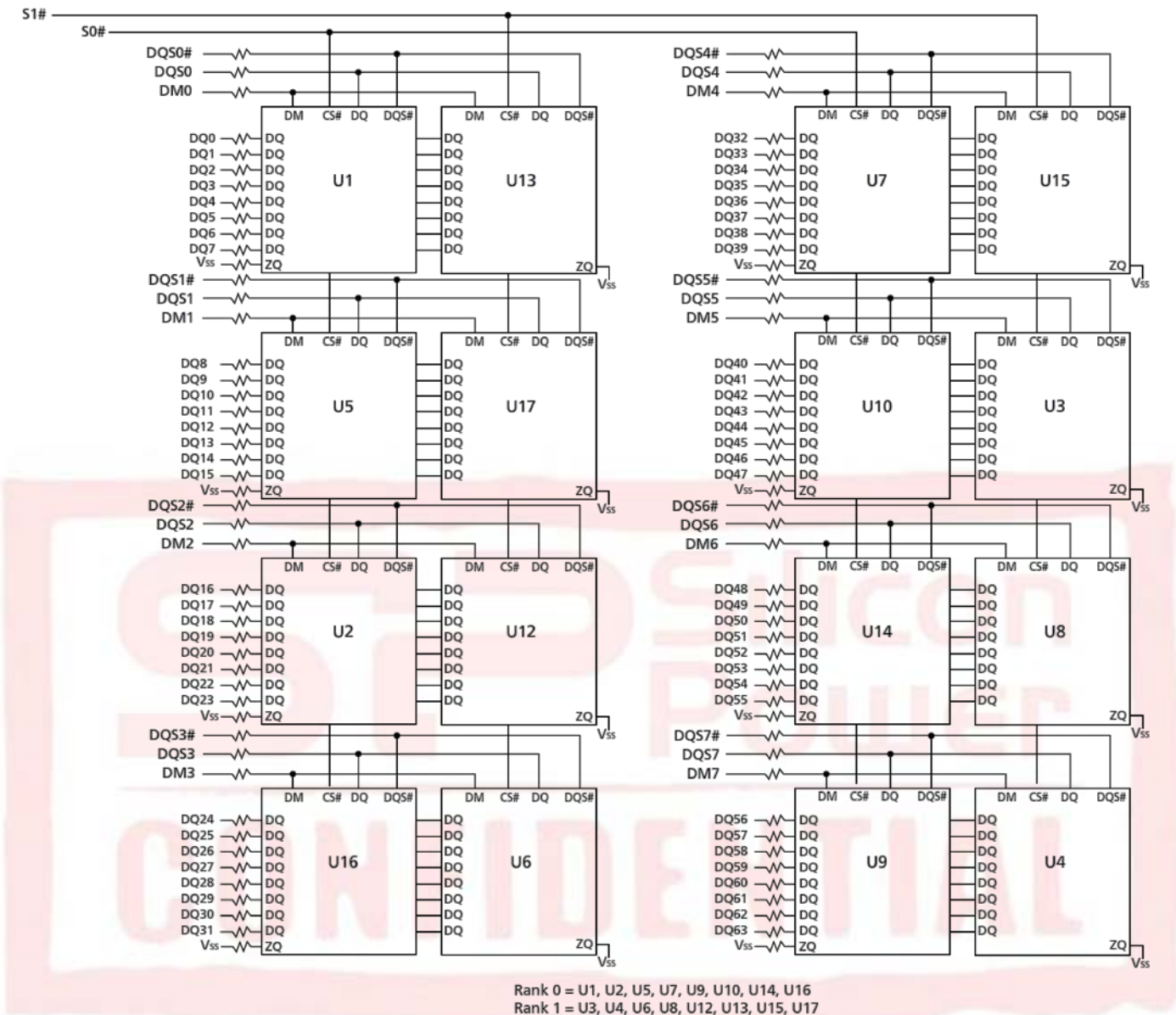

- BA[2:0] → BA[2:0]: DDR3 SDRAM
- A[15:0] → A[15:0]: DDR3 SDRAM
- RAS# → RAS#: DDR3 SDRAM
- CAS# → CAS#: DDR3 SDRAM
- WE# → WE#: DDR3 SDRAM
- CKE0 → CKE0: Rank 0
- CKE1 → CKE1: Rank 1
- ODT0 → ODT0: Rank 0
- ODT1 → ODT1: Rank 1
- RESET# → RESET#: DDR3 SDRAM

Command, address and clock line terminations

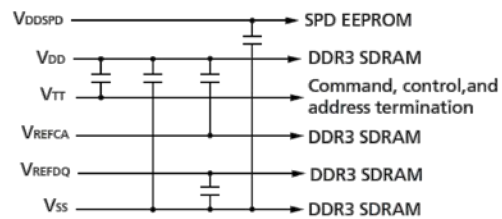
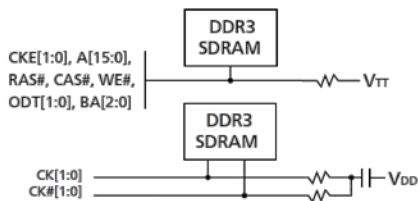

**Note:** The ZQ ball on each DDR3 component is connected to an external 240Ω resistor that is tied to ground. It is used for the calibration of the component's ODT and output driver.

### Block Diagram(x16 1Rank)

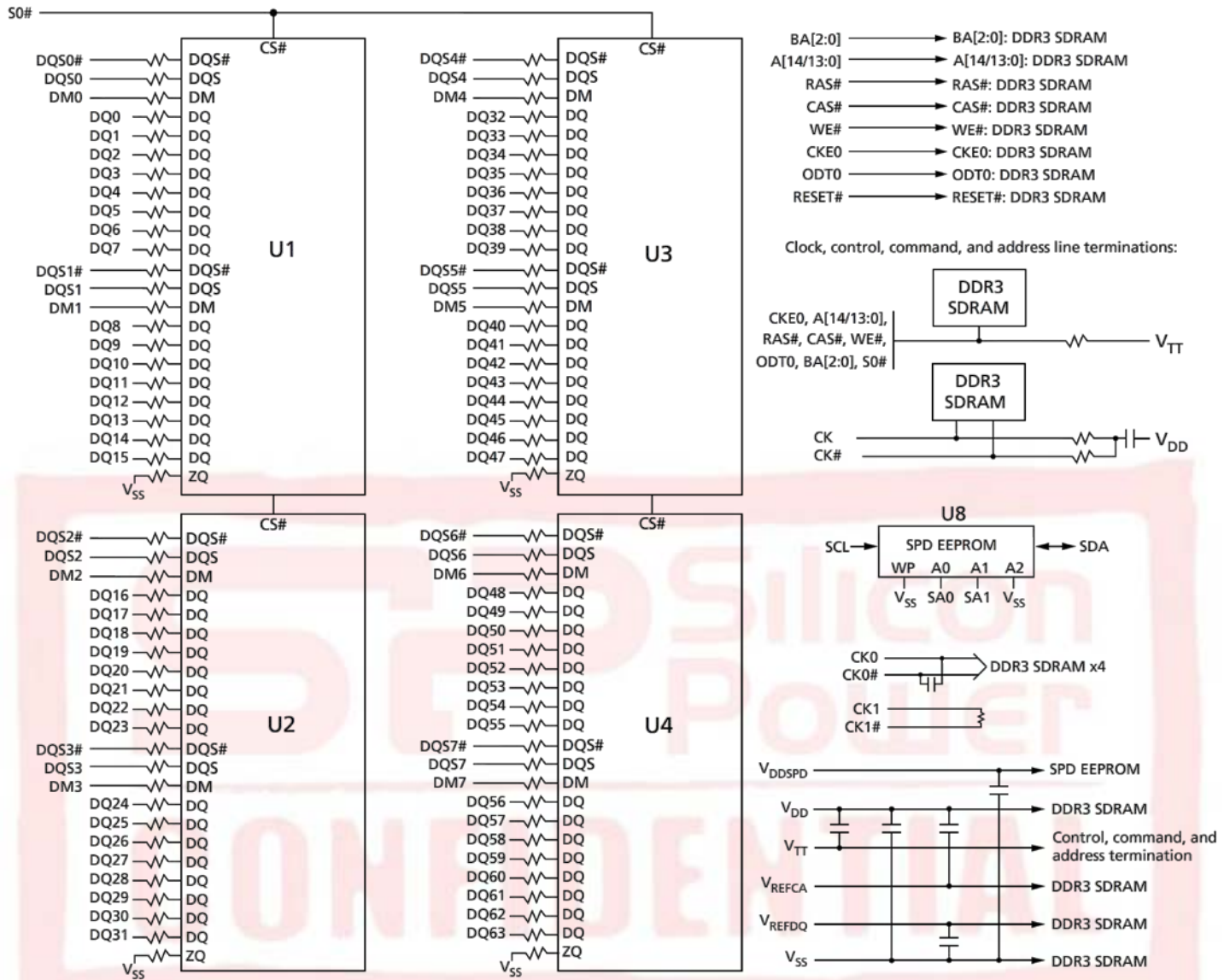

**Note:** The ZQ ball on each DDR3 component is connected to an external 240Ω resistor that is tied to ground. It is used for the calibration of the component's ODT and output driver.

### Block Diagram(x16 2Ranks)

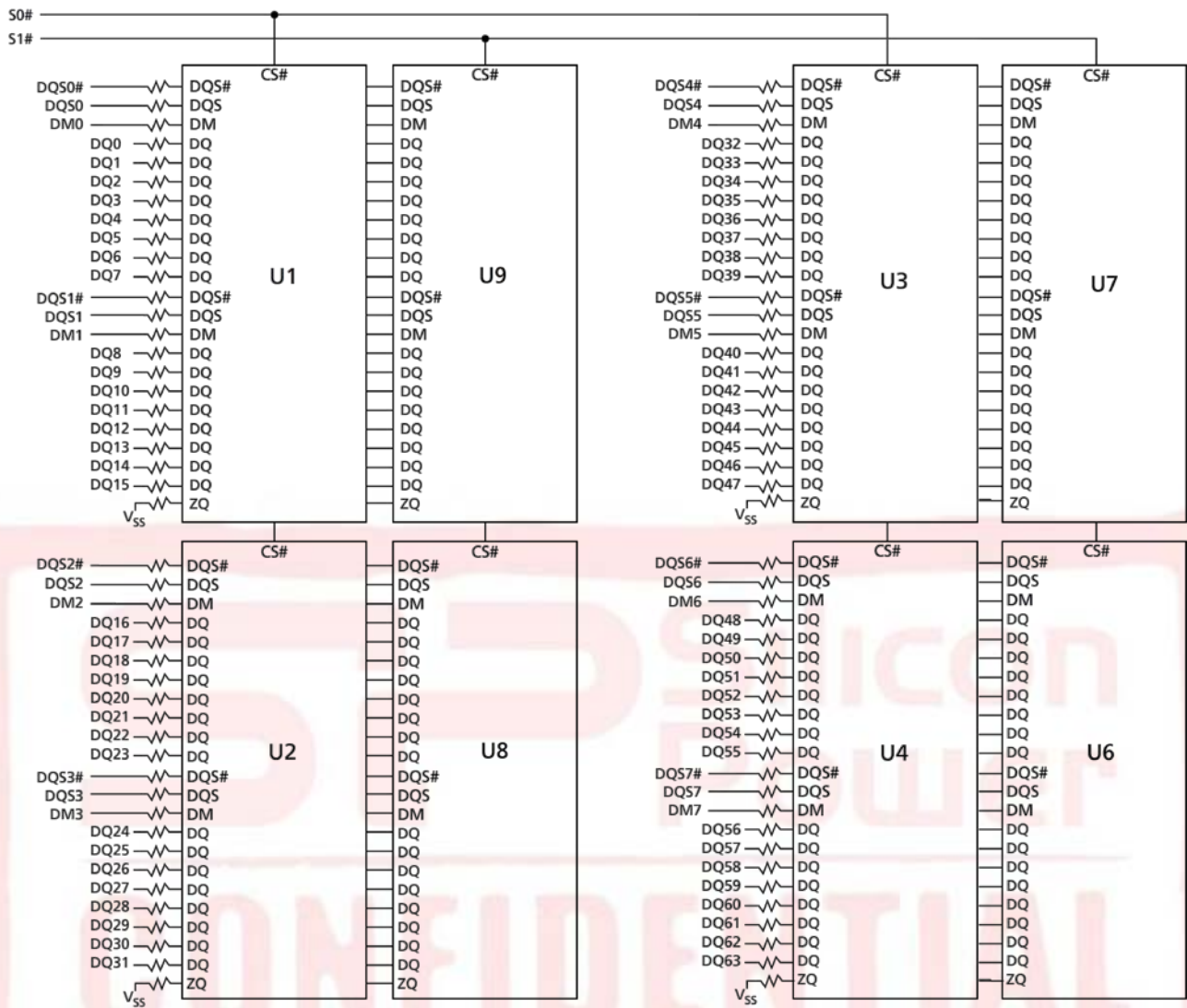

- BA[2:0] → BA[2:0]: DDR3 SDRAM
- A[14/13:0] → A[14/13:0]: DDR3 SDRAM
- RAS# → RAS#: DDR3 SDRAM
- CAS# → CAS#: DDR3 SDRAM
- WE# → WE#: DDR3 SDRAM
- CKE[1:0] → CKE0[1:0]: DDR3 SDRAM
- ODT[1:0] → ODT0[1:0]: DDR3 SDRAM
- RESET# → RESET#: DDR3 SDRAM

Clock, control, command, and address line terminations:

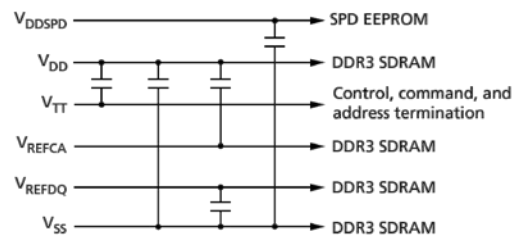
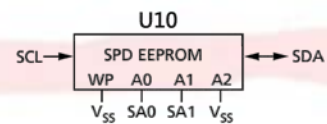
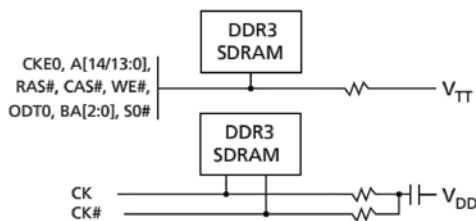

**Note:** The ZQ ball on each DDR3 component is connected to an external 240Ω resistor that is tied to ground. It is used for the calibration of the component's ODT and output driver.

### Simplified Mechanical Drawing(x8 1Rank)

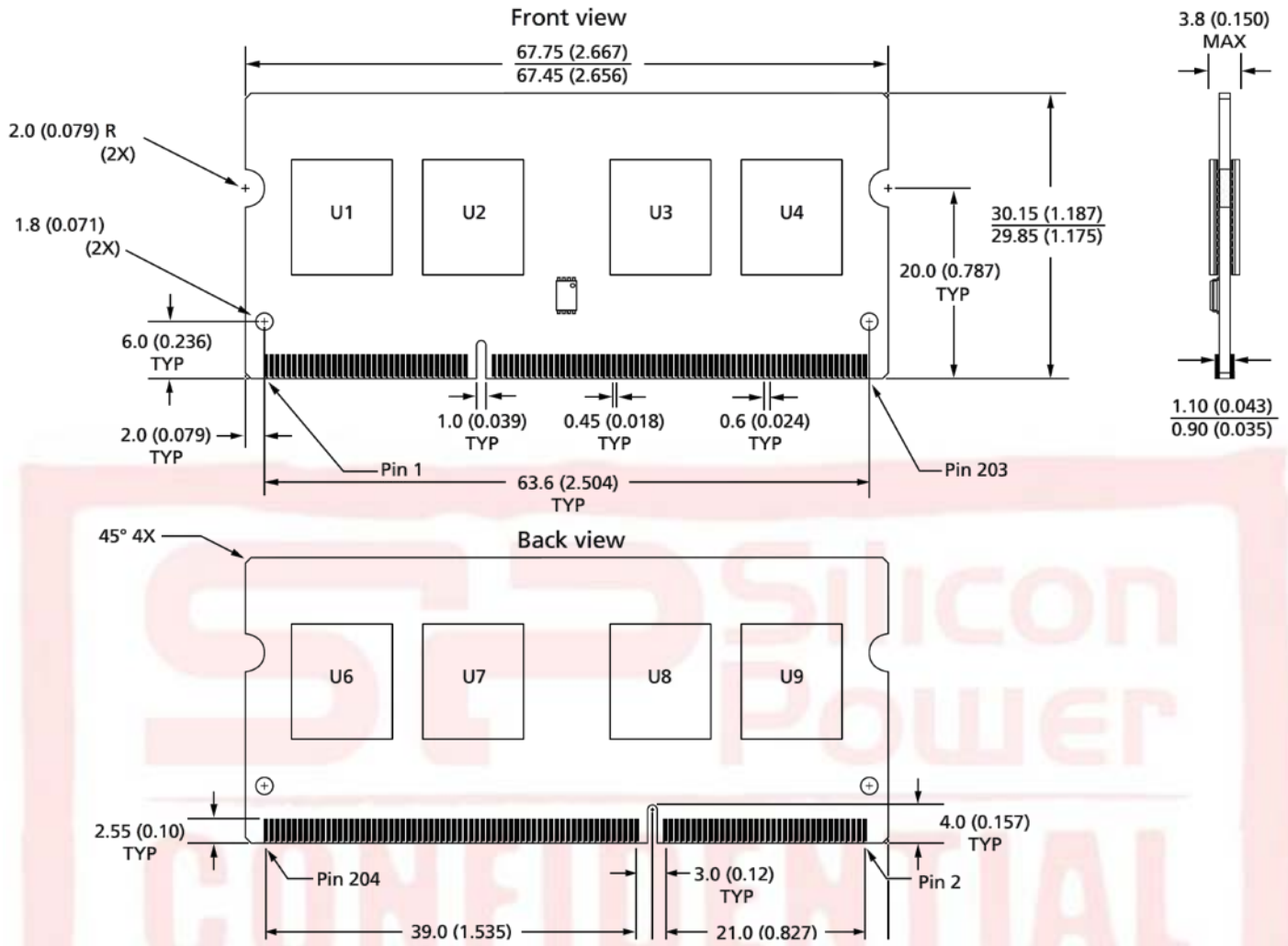

**Note:** 1. All dimensions are in millimeters (inches); MAX/MIN or typical (TYP) where noted.

**Note:** 2. The dimensional diagram is for reference only.



### Simplified Mechanical Drawing(x8 2Ranks)

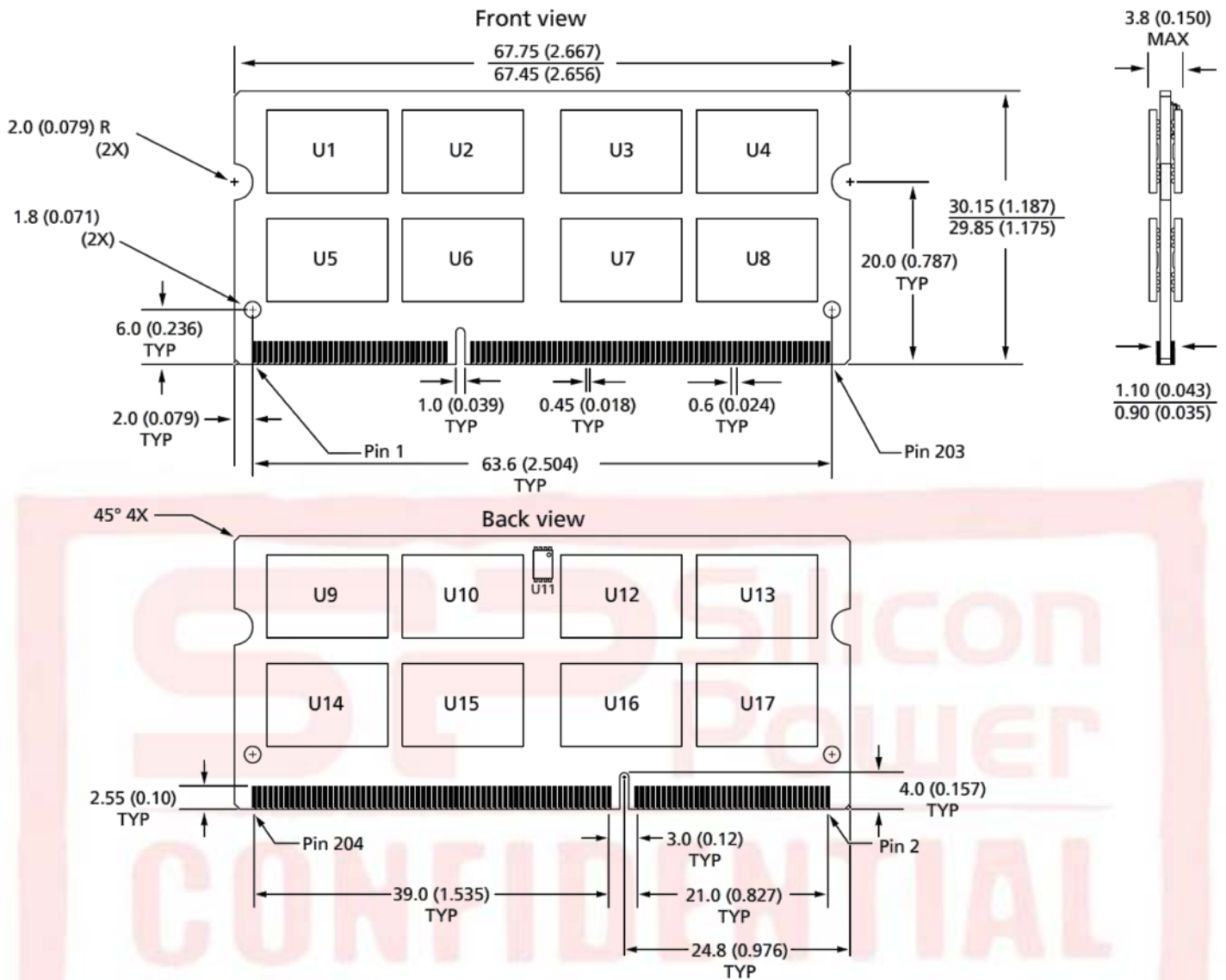

**Note 1:** All dimensions are in millimeters (inches); MAX/MIN or typical (TYP) where noted.

**Note 2:** The dimensional diagram is for reference only.

### Simplified Mechanical Drawing(x16 1Rank)

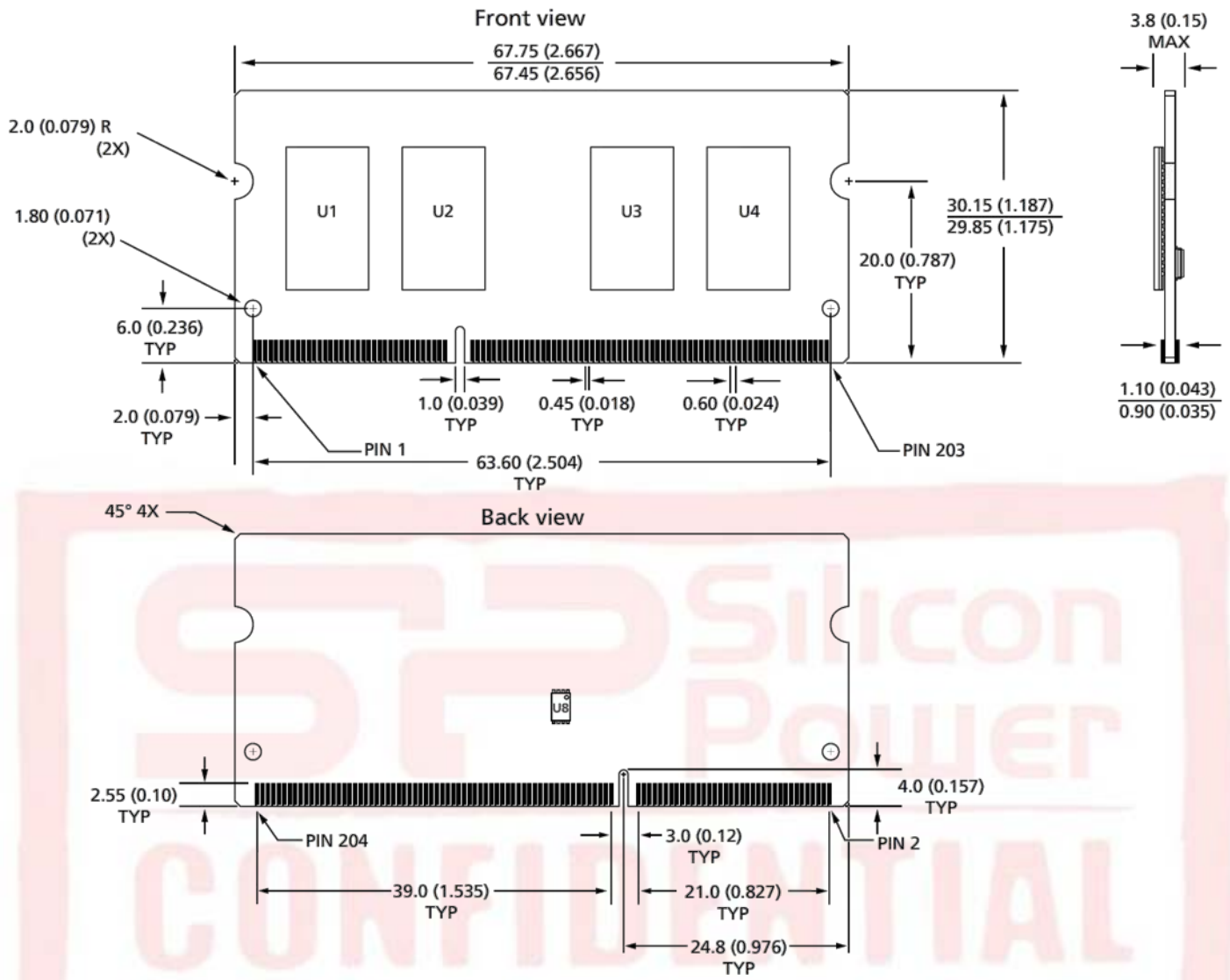

**Note:** 1. All dimensions are in millimeters (inches); MAX/MIN or typical (TYP) where noted.

**Note:** 2. The dimensional diagram is for reference only.

**Simplified Mechanical Drawing(x16 2Ranks)**

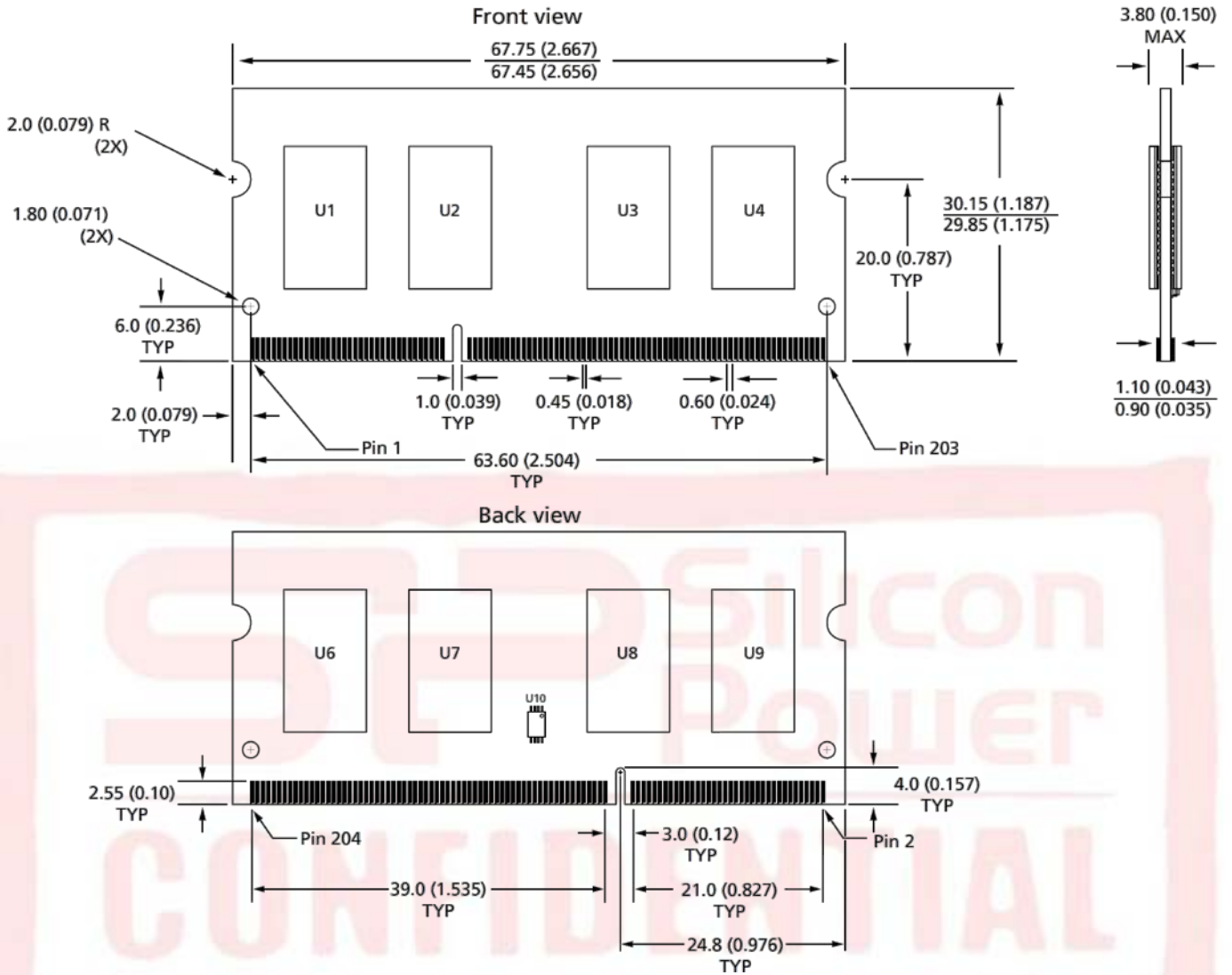

**Note 1:** All dimensions are in millimeters (inches); MAX/MIN or typical (TYP) where noted.

**Note 2:** The dimensional diagram is for reference only.