



NEXCOM International

Mobile Computing Solutions

Vehicle Mount Display

VMD Series

User Manual

Contents

Preface

Copyright Notice.....	iii
Acknowledgements.....	iii
Declaration of Conformity.....	iii
Installation Recommendations.....	iv

Warranty and RMA

NEXCOM Warranty Period.....	vi
NEXCOM Return Merchandise Authorization (RMA).....	vi
Global Service Contact Information.....	vii
Headquarters.....	vii

Chapter 1: Product Introduction

VMD Products Physical Features.....	1
VMD Products Package Contents.....	2
VMD Products Hardware Specifications.....	3
VMD 1000 Dimensions.....	5
VMD 1001 Dimensions.....	6
VMD 2000/ 2002 Dimensions.....	7
Ordering Information.....	8
VMD Series Standard Ordering Information.....	8

Chapter 2: VMD Series Hardware Functionality

Front Panel & Rear Panel Functions.....	9
VMD 1000/2000/2002 Rear Panel.....	10
VMD 1001 Rear Panel.....	11

Chapter 3: Hardware Installation

Assembling the Stand.....	12
Assembling the VESA Mount Plate.....	13
Connecting to VTC series with the LVDS Cable.....	14

Chapter 4: OSD Function

Menu Structure of the Screen Adjustment.....	15
Button Function.....	16
Auto Adjust.....	17
Luminance.....	17
Geometry.....	18
Color.....	18
Color - User Preset.....	19
Volume.....	19
OSD.....	20
Language.....	20
Recall.....	21
Miscellaneous.....	21

Preface

Thank you for purchasing NEXCOM's industrial-grade VMD 1000, the sunlight readable touch screen LVDS display panel designed to be the ultimate interactive display monitor for your VTC series, unleashing the multimedia capabilities of your VTC series.

The VMD 1000 connects to the VTC series with a special LVDS cable that integrates LVDS signals, USB connection, and power supply, all in one rugged, easy-to-connect cable. With this connection made, VMD 1000 acts as a remote power switch of VTC series (thanks to its power on/off button). Additionally, it has built-in USB ports, audio/mic inputs and outputs, 2 audio speakers onboard for built-in stereo sound, available automatic brightness adjustment (controlled by an onboard light sensor), and much more.

The specially designed touch screen, which is readable even under bright sunlight, makes it easy to use many functions of the VTC series. Moreover, the front panel is IP54-compliant, which means that it is dust protected and water-splash resistant. Furthermore, the 4 rubber protectors can be installed on the 4 corners as protection cushions.

Copyright Notice

All rights reserved. No part of this manual may be reproduced, transmitted, transcribed, stored in a retrieval system, or translated into any language or computer language, in any form or by any means (electronic, mechanical, photocopying, recording, or otherwise), without the express written permission of NEXCOM.

Information provided in this manual is intended to be accurate and reli-

able. However, the original manufacturer assumes no responsibility for its use, nor for any infringements upon the rights of third parties that may result from such use.

Copyright © 2011 NEXCOM International Co., Ltd.

Acknowledgements

VMD 1000 is a trademark of NEXCOM International Co., Ltd.

Intel and Pentium are trademarks of Intel Corporation. Microsoft Windows® is a registered trademark of Microsoft Corporation. All other product names or trademarks are properties of their respective owners.

Declaration of Conformity

CE

This product has passed the CE test for environmental specifications when shielded cables are used for external wiring. We recommend the use of shielded cables. Please contact your local supplier for ordering information.

This product has passed the CE test for environmental specifications. Test conditions for passing included the equipment being operated within an industrial enclosure. In order to protect the product from being damaged by ESD (Electrostatic Discharge) and EMI leakage, we strongly recommend the use of CE-compliant industrial enclosure products.

FCC Class A

This equipment has been tested and found to comply with the limits for a Class A digital device, pursuant to part 15 of the FCC Rules.

These limits are designed to provide reasonable protection against harmful interference when the equipment is operated in a commercial environment.

This equipment generates, uses, and can radiate radio frequency energy and, if not installed and used in accordance with the instruction manual, may cause harmful interference to radio communications.

Operation of this equipment in a residential area is likely to cause harmful interference in which case the user will be required to correct the interference at his own expense.

RoHS Compliance

NEXCOM RoHS Environmental Policy and Status Update



NEXCOM is a global citizen for building the digital infrastructure. We are committed to providing green products and services, which are compliant with European Union RoHS (Restriction on Use of Hazardous Substance in Electronic Equipment) directive 2002/95/EU, to be your trusted green partner and to protect our environment.

RoHS restricts the use of Lead (Pb) < 0.1% or 1,000ppm, Mercury (Hg) < 0.1% or 1,000ppm, Cadmium (Cd) < 0.01% or 100ppm, Hexavalent Chromium (Cr6+) < 0.1% or 1,000ppm, Polybrominated biphenyls (PBB) < 0.1% or 1,000ppm, and Polybrominated diphenyl Ethers (PBDE) < 0.1% or 1,000ppm.

In order to meet the RoHS compliant directives, NEXCOM has established an engineering and manufacturing task force in to implement the introduction of green products. The task force will ensure that we follow the standard NEXCOM development procedure and that all the new RoHS components and new manufacturing processes maintain the highest industry quality levels for which NEXCOM are renowned.

The model selection criteria will be based on market demand. Vendors and suppliers will ensure that all designed components will be RoHS compliant.

How to Recognize NEXCOM RoHS Products

For existing products where there are non-RoHS and RoHS versions, the suffix "(LF)" will be added to the compliant product name.

All new product models launched after January 2006 will be RoHS compliant. They will use the usual NEXCOM naming convention.

Installation Recommendations

Ensure you have a stable, clean working environment. Dust and dirt can get into components and cause a malfunction. Use containers to keep small components separated.

Adequate lighting and proper tools can prevent you from accidentally damaging the internal components. Most of the procedures that follow require only a few simple tools, including the following:

- A Philips screwdriver
- A flat-tipped screwdriver
- A grounding strap
- An anti-static pad

Using your fingers can disconnect most of the connections. It is recommended that you do not use needlenose pliers to disconnect connections

as these can damage the soft metal or plastic parts of the connectors.

Handling Precautions

- Always disconnect the unit from the power outlet whenever you are installing or fixing a component inside the chassis.
- If possible, always wear a grounded wrist strap when you are installing or fixing a component inside the chassis. Alternatively, discharge any static electricity by touching the bare metal chassis of the unit case, or the bare metal body of any other grounded appliance.
- Hold electronic circuit boards by the edges only. Do not touch the components on the board unless it is necessary to do so. Do not flex or stress the circuit board.
- Use the correct screws and do not overly tighten them.
- Keep the original packaging and static-protective bag in case the unit has to be returned.

Warranty and RMA

NEXCOM Warranty Period

NEXCOM manufactures products that are new or equivalent to new in accordance with industry standard. NEXCOM warrants that products will be free from defect in material and workmanship for 24 months beginning on the date of invoice by NEXCOM. HCP series products (Blade Server) which are manufactured by NEXCOM are covered by a three year warranty period.

NEXCOM Return Merchandise Authorization (RMA)

- Customers shall enclose the “NEXCOM RMA Service Form” with the returned packages.
- Customers must collect all the information about the problems encountered and note anything abnormal or, print out any on-screen messages, and describe the problems on the “NEXCOM RMA Service Form” for the RMA number apply process.
- Customers can send back the faulty products with or, without accessories (manuals, cables, etc.) and any unnecessary components from the card, such as CPU and DRAM. If the components were suspected as part of the problems, please note clearly that which components are included. Otherwise, NEXCOM is not responsible for the devices/parts.
- Customers are responsible to for the safe packaging of defective products are durable enough to be resistant against further damage and deterioration during transportation. In case of damages occurred during the transportation, the repair is treated as “Out of Warranty.”

- Any products returned by NEXCOM to other locations besides the customers’ site will bear an extra charge and will be billed to the customer.

Repair Service Charges for Out-of-Warranty Products

NEXCOM will charge for out of warranty products in two categories, one is basic diagnostic fee and another is component (product) fee.

System Level

- Component fee: NEXCOM will only charge for main components, such as SMD chip, BGA chip, etc. Passive components will be repaired for free, ex: resistor, capacitor.
- Items will be replaced with NEXCOM products if the original one is not able to be repaired. Ex: motherboard, power supply, etc.
- Replaced with 3rd party products if needed.
- If RMA goods cannot be repaired, NEXCOM will return it to customer without any charge.

Board Level

- Component fee: NEXCOM will only charge for main components, such as SMD chip, BGA chip, etc. Passive components will be repaired for free, ex: resistors, capacitors.
- If RMA goods can not be repaired, NEXCOM will return it to customer without any charge.

Global Service Contact Information

Headquarters

NEXCOM International Co., Ltd.

15F, No. 920, Chung-Cheng Rd.,
ZhongHe District, New Taipei City, 23586,
Taiwan, R.O.C.
Tel: +886-2-8226-7786
Fax: +886-2-8226-7782
www.nexcom.com

America

USA

NEXCOM USA

2883 Bayview Drive,
Fremont CA 94538, USA
Tel: +1-510-656-2248
Fax: +1-510-656-2158
Email: sales@nexcom.com
www.nexcom.com

Asia

Taiwan

Central Taiwan Office

16F, No.250, Sec. 2, Chongde Rd.,
Beitun Dist., Taichung City 406, R.O.C.
Tel: +886-4-2249-1179
Fax: +886-4-2249-1172
Email: sales@nexcom.com.tw
www.nexcom.com.tw

Japan

NEXCOM Japan

9F, Tamachi Hara Bldg., 4-11-5, Shiba Minato-ku,
Tokyo, 108-0014, Japan
Tel: +81-3-5419-7830
Fax: +81-3-5419-7832
Email: sales@nexcom-jp.com
www.nexcom-jp.com

China

NEXCOM China

2F, Block 4, Venus Plaza, Bldg. 21,
ZhongGuanCun Software Park, No. 8,
Dongbeiwang West Rd., Haidian District,
Beijing, 100193, China
Tel: +86-10-8282-6599
Fax: +86-10-8282-5955
Email: sales@nexcom.cn
www.nexcom.cn

Shanghai Office

Room 603/604, Huiyinmingzun Plaza Bldg., 1,
No.609, Yunlin East Rd.,
Shanghai, 200062, China
Tel: +86-21-5278-5868
Fax: +86-21-3251-6358
Email: sales@nexcom.cn
www.nexcom.cn

Shenzhen Office

Room1707, North Block, Pines Bldg.,
No.7 Tairan Rd., Futian Area,
Shenzhen, 518040, China
Tel: +86-755-8332-7203
Fax: +86-755-8332-7213
Email: sales@nexcom.cn
www.nexcom.cn

Wuhan Office

1-C1804/ 1805, Mingze Liwan,
No. 519 South Luoshi Rd.,
Hongshan District,
Wuhan, 430070, China
Tel: +86-27-8722-7400
Fax: +86-27-8722-7400
Email: sales@nexcom.cn
www.nexcom.cn

Chengdu Office

9F, Shuxiangxie, Xuefu Garden,
No.12 Section 1, South Yihuan Rd.,
Chengdu, 610061, China
Tel: +86-28-8523-0186
Fax: +86-28-8523-0186
Email: sales@nexcom.cn
www.nexcom.cn

Europe

Italy

NEXCOM ITALIA S.r.l

Via Gaudenzio Ferrari 29,
21047 Saronno (VA), Italia
Tel: +39 02 9628 0333
Fax: +39 02 9286 9215
Email: nexcomitalia@nexcom.eu
www.nexcomitalia.it

United Kingdom

NEXCOM EUROPE

10 Vincent Avenue,
Crownhill Business Centre,
Milton Keynes, Buckinghamshire MK8 0AB,
United Kingdom
Tel: +44-1908-267121
Fax: +44-1908-262042
Email: sales.uk@nexcom.eu
www.nexcom.eu

Chapter 1: Product Introduction

VMD Products Physical Features

VMD Products are designed to be a commander of the transportation PC in vehicles or vessels. The VMD 1000/ 2000 connect to VTC series with only a single cable that integrates LVDS signal, USB and 12V DC power. Through this connection, VMD 1000/ 2000 have a remote power on/off switch of the VTC series, while many functions of the VTC series can be controlled via the sunlight-readable touch screen.

VMD 1001 supports standard VGA interface, it can be configured to link to most vehicle computers.

All VMD products also provides USB and card reader features, and reserves camera sensor as an option. Those friendly interfaces benefit the technicians during maintenances.

Brightness of the LCD can be adjusted manually or automatically. The user can control the volume for GPS vocal navigation. Designed with ingress protection, VMD 1000 has IP54 protection on the front panel.

VMD Products Package Contents

Before continuing, verify that the VMD Products package that you received is complete. Your VMD products package should have all the items listed in the following table.

Item	VMD 1000	VMD 1001	VMD 2000	VMD 2002
Product	✓	✓	✓	✓
PWR, USB, VGA integrated cable				✓
LVDS Cable (1.5 m)	✓		✓	
VGA Cable		✓		
USB Cable		✓		
Audio Cable (1 for VTC61xx Series, 1 for VTC6200/VTC2100 Series)	2	2	2	2
Mic Cable	✓		✓	✓
VESA75 Plate	✓	✓	✓	✓
Stand	✓	✓		
Long Screws	2	2		
CD (User Manual and Touch Screen Driver)	✓	✓	✓	✓

If any of these items are missing or damaged, contact your local NEXCOM distributor or sales representative immediately. Your NEXCOM products should be free of defects and in perfect working order upon receipt.

While unpacking, check for signs of shipping damage (for example, damaged box, scratches, dents, etc.) If it is damaged or it fails to meet the specifications, notify the NEXCOM service department or your local sales representative immediately. Also notify the carrier. Retain the shipping carton and packing material for inspection by the carrier.

After inspection, NEXCOM will make arrangements for repair or replacement.

VMD Products Hardware Specifications

The following are the hardware specifications of VMD 1000/ 1001/ 2000/ 2002.

LCD Specification

VMD 1000/ 1001

- Type: 7" LVDS (Panel with LED backlight)
- Resolution: VMD1000: WVGA 800 x 480
VMD1001: VGA 640 x 480
- Brightness: 500 cd/m² (typical)
- Contrast ratio: 600:1 (typical)
- Colors: 16.7M
- Viewing angle:
 - <V>65/65
 - <H>80/80

VMD 2000/ 2002

- Type: 8" LVDS (Panel with LED backlight)
- Resolution: SVGA 800 x 600
- Brightness: 400 cd/m² (typical)
- Contrast ratio: 500:1 (typical)
- Colors: 256K
- Viewing angle:
 - <V>50/70
 - <H>70/70

Touch Screen Sensor

- 4-wire resistive touch
- anti-glare coating surface
- transmission rate: 82+- 3%

Front Panel

- Control Buttons x 5 Power On/ Off Volume Control (+/-) Brightness Control (+/-)
- Light Sensor
- LED Indicators x 2
- Built-in speakers (1.2W) x 2

Lateral Side I/O

VMD 1000/ 2000/ 2002

- 1 x USB type A for Storage
- 1 x Line-out (switch to external speaker by auto detection)
- 1 x Mic-in (from external microphone)
- 1 x SD/ MMC/ MS Card Reader

VMD 1001

- 1 x USB type A for Storage
- 1 x Line-out (switch to external speaker by auto detection)

Note* : the operating temperature is based on the standard configuration (No CCD camera, No Low Reflection touch)

- 1 x Line-in (from VTC Line-out)
- 1 x SD/ MMC/ MS Card Reader

Bottom Side I/O

VMD 1000/ 2000

- Remote System Power On/ Off Button
- 1 x Mic-out (to VTC Mic-in)
- 1 x Line-in (from VTC Line-out)
- 1 x LVDS Connector (integrating LVDS, USB x 1 and 12Vdc x 1)

VMD 1001

- 1 x Power connector
- 1 x USB type B for touch screen and USB hub
- 1 x VGA

VMD 2002

- 1 x Mic-out (to VTC Mic-in)
- 1 x Line-in (from VTC Line-out)
- 1 x DVI-D Connector (integrating VGA, USB and 9~36Vdc)

Optional Features:

- 2.0M pixels CCD Camera on front panel
- Sunlight-Readable Display with High Brightness LCD (800 cd/m²)
- VESA mounting hole support kit

Enclosure

- Plastic housing
- Front panel compliance with IP54

Environment

- Operating Temperature: VMD 1000/ 1001: -20°C ~ 70°C (*)
VMD 2000: -20°C ~ 60°C (*)
- Storage Temperature: VMD 1000/ 1001: -30°C ~ 80°C
VMD 2000/ 2002: -30°C ~ 70°C

Certification

- CE
- FCC Class B

Note* : the operating temperature is based on the standard configuration (No CCD camera, No Low Reflection touch)

VMD 1000 Dimensions

- 182 x 138 x 36.3 mm
- 0.45 Kg (0.99 Lb)

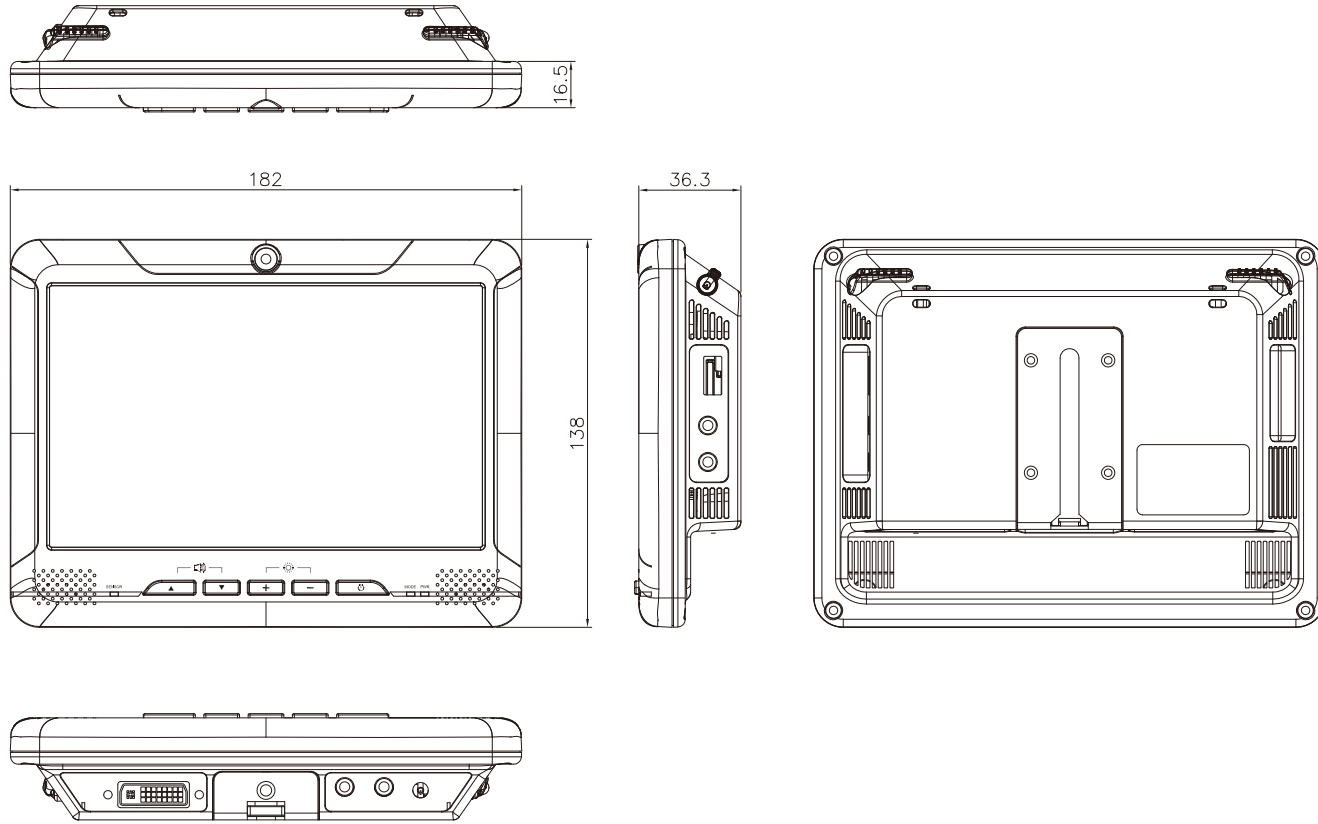

VMD 1001 Dimensions

- 182 x 138 x 36.3 mm
- 0.45 Kg (0.99 Lb)

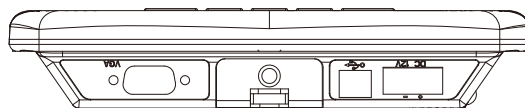
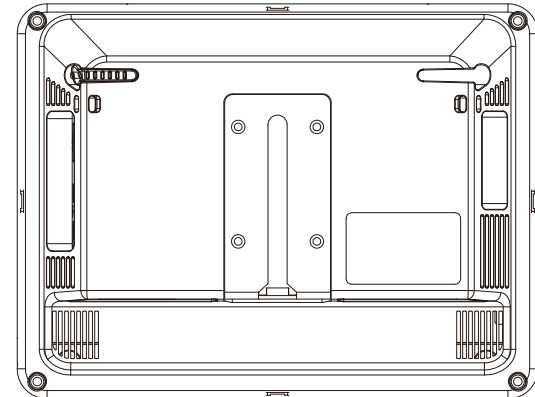
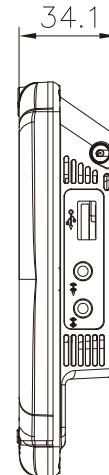
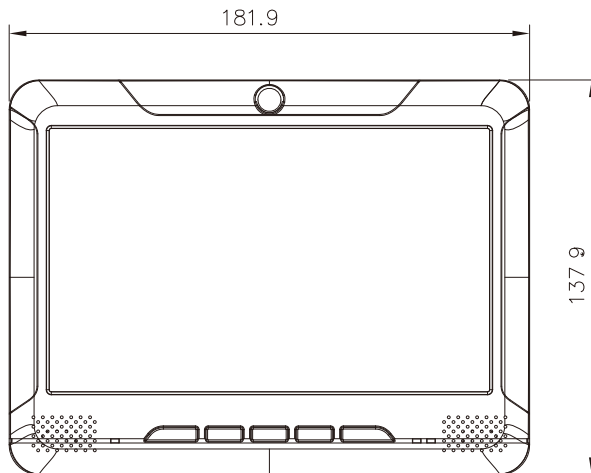
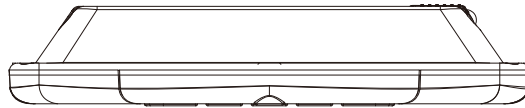

VMD 2000/ 2002 Dimensions

- 207 x 173mm x 36.7mm
- 0.7 Kg (1.54 Lb)

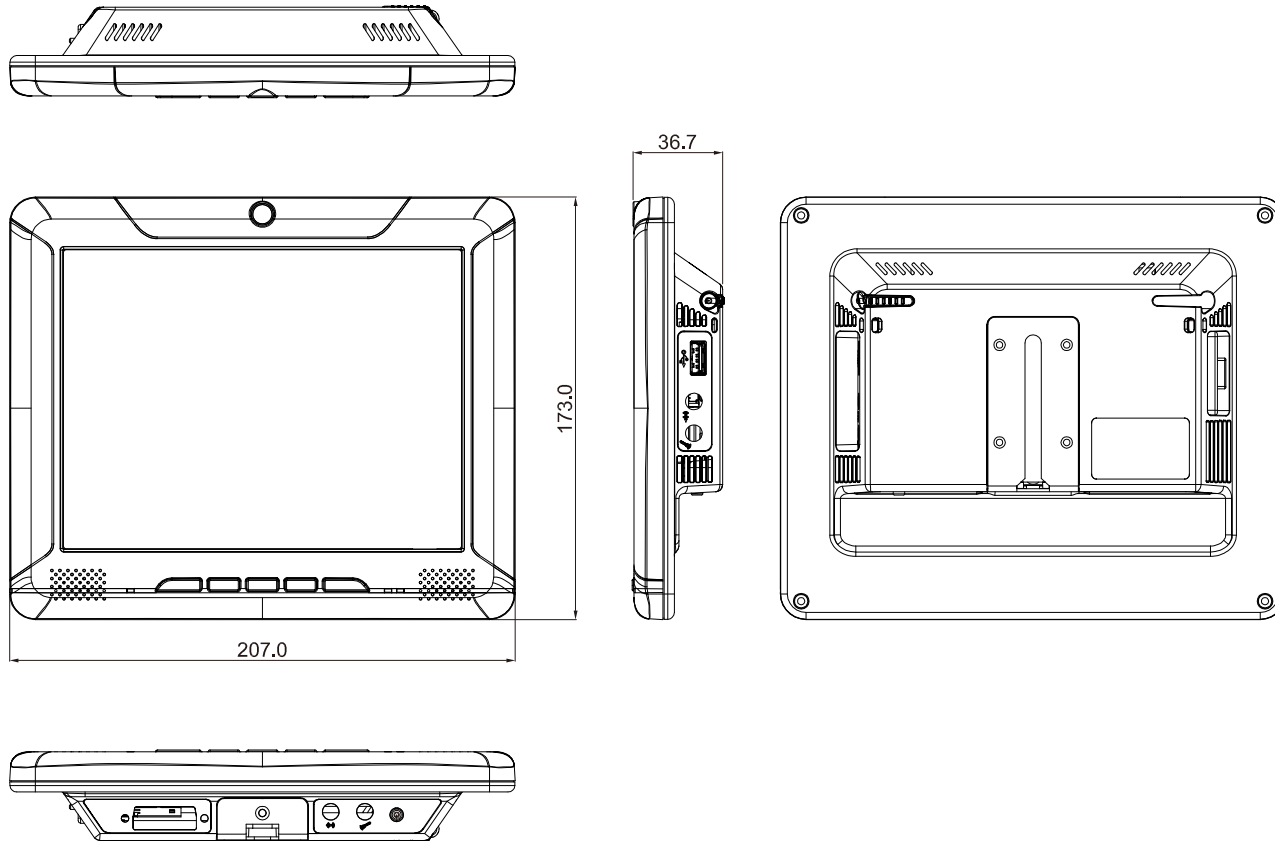

Ordering Information

Refer to the tables below for the appropriate ordering information of VMD Series.

VMD Series Standard Ordering Information

VMD 1000 (P/N: 10VD0100000X0)	<ul style="list-style-type: none"> 7" WVGA LCD with Touch Screen Vehicle Display
VMD 2000 (P/N: 10VD0200000X0)	<ul style="list-style-type: none"> 8" SVGA vehicle mount display with touch screen and LVDS interface
Bundle Accessories	<ul style="list-style-type: none"> LVDS Cable (1.5m) Metal Mounting Kit (VMD1000 only) Audio x 2 / Mic Cable *Note CD (User Manual and Touch Screen Driver)

VMD 1001 (P/N: 10VD0100101X0)	<ul style="list-style-type: none"> 7" WVGA vehicle mount display with touch screen and VGA interface
Bundle Accessories	<ul style="list-style-type: none"> 2pin power connector VGA Cable (1.5m) USB Cable (1.5m) VESA Mount Kit Audio Cable Mic Cable Power Cable CD (User Manual and Touch Screen Driver)

Note:



Audio cable for VTC6200 & 2100



Audio cable for VTC61xx Series

VMD 2002 (P/N: 10VD0200200X0)	<ul style="list-style-type: none"> 8" SVGA vehicle mount display with touch screen and USB, VGA and Power cable integrated
Bundle Accessories	<ul style="list-style-type: none"> Integrate Cable with PWR, USB and VGA (1.5m) VESA Mount Kit Audio Cable Mic Cable CD (User Manual and Touch Screen Driver)

Chapter 2: VMD Series Hardware Functionality

Front Panel & Rear Panel Functions

Front Panel



1. Power On/Off Control
Press this button for 4 seconds -- the monitor will turn on.
2. Brightness Control
There are two modes for Brightness Control:
Manual Mode
LCD brightness can be adjusted in 4 levels using the **+** **-** buttons.
Auto Mode
The built-in light sensor will detect environmental brightness and adjust LCD brightness automatically.
Switching between Manual Mode and Auto Mode
To toggle between *Manual Mode* and *Auto Mode*, press and hold the **+** **-** buttons for 4 seconds.
3. Volume Control
Audio volume can be adjusted in 8 levels using the **+** **-** buttons.
4. LED
PWR LED is turned on when VMD 1000 is powered on.
Mode LED is turned on when brightness control is in Auto Mode
5. Light Sensor

NOTE: 1. The example photo is VMD1000/1001.
2. The all VMD series are all the same functionality with function keys.

VMD 1000/2000/2002 Rear Panel

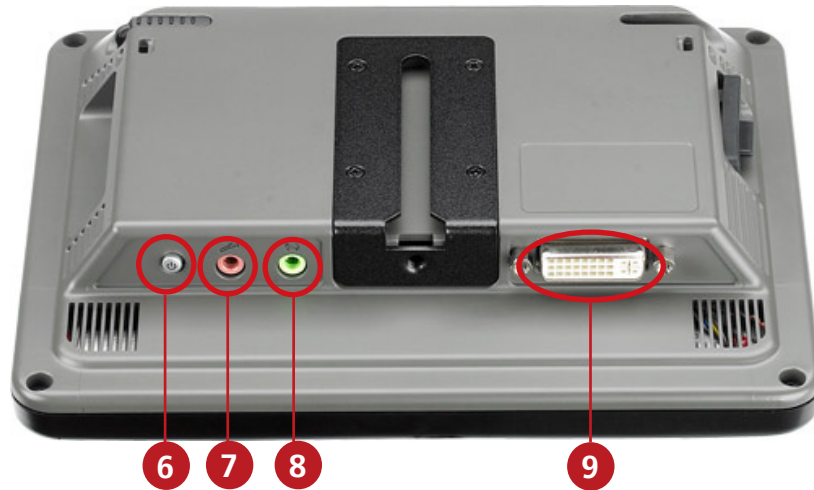

6. Remote power on/off control for VTC series –
Switch VTC series on or off with this button (not for VMD 2002).

7. Mic-Out

8. Line-In

9. DVI Connector – for connection to VTC series
(please see Chapter 3 for more details).

NOTE: 1. The example photos are VMD 1000.

2. The I/O functions are the same with VMD 1000 and 2000.

3. This connector is not for standard DVI interface.

4. For VMD 2002, it is integrate power, USB and VGA interface



10. USB

11. Line-out

12. Mic-in

13. SD/ MMC/ MS Card Reader

VMD 1001 Rear Panel

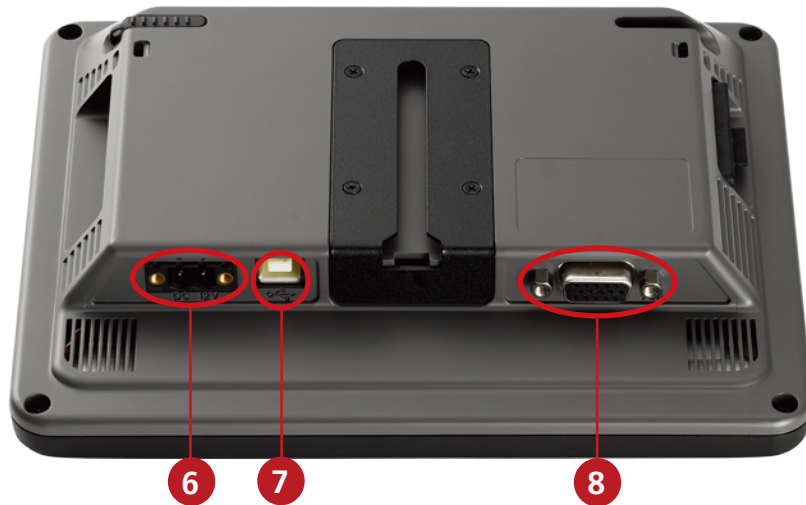

6. Power Connector

7. USB Connector – the connector is for touch screen function, function keys and card reader data transmission.

8. VGA

9. USB

10. Line-in – for connection to line-out of VTC series.

11. Line-out

12. SD/ MMC/ MS Card Reader

Chapter 3: Hardware Installation

Assembling the Stand

NOTE: Optional kits.

1. Fasten the black metal plate onto the rear panel with the 4 screws.

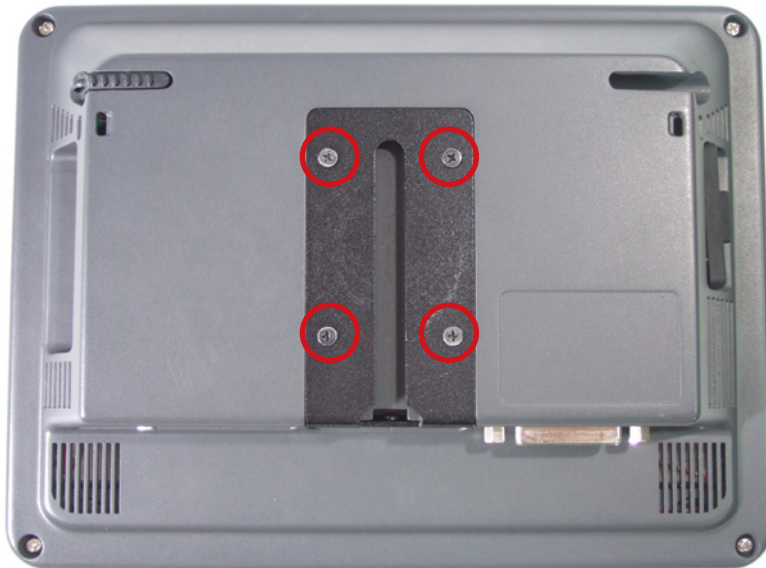

2. Assemble the monitor stand with the 2 long screws.

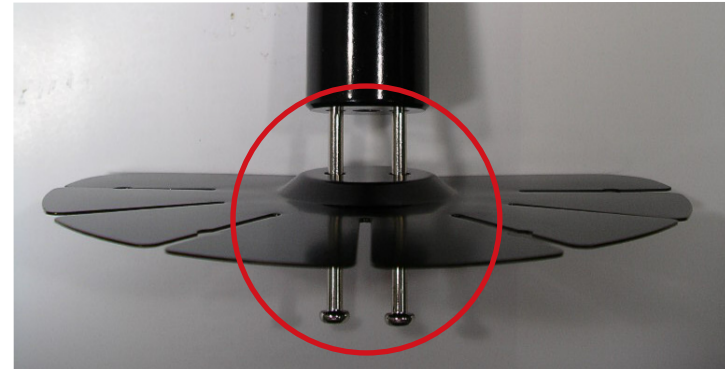

3. Attach and fasten the LCD panel onto the monitor stand.



Assembling the VESA Mount Plate

VMD series use the same VESA 75 plate; please follow the steps below to install the mount plate.

1. Remove the 4 screws on the black metal plate.
2. Place the VESA mount plate on the black metal plate and then fasten the four screws.

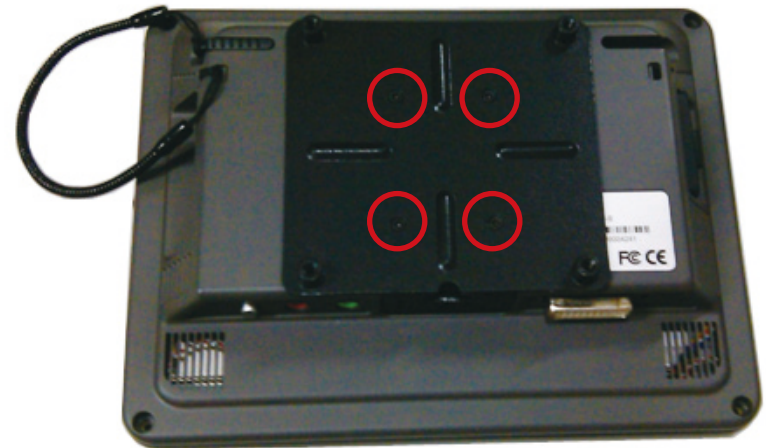
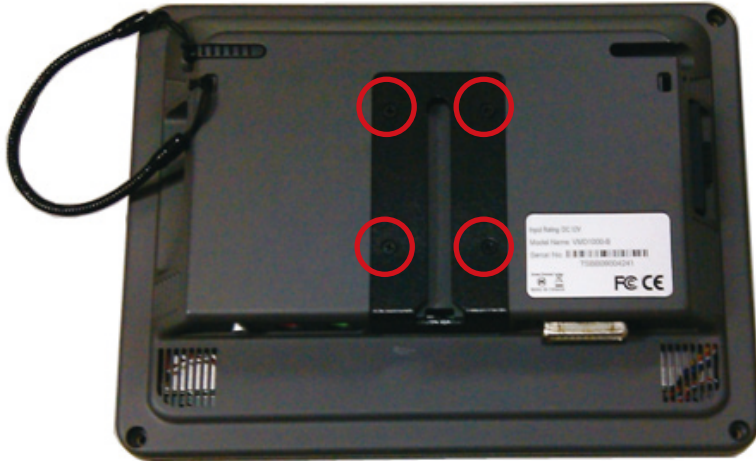

Connecting to VTC series with the LVDS Cable

NOTE: LVDS cable is only for VMD 1000/2000.

1. Connect and fasten the DVI end of the LVDS cable onto the DVI port.

NOTE: Use only NEXCOM's proprietary LVDS cable for this DVI port. Pin assignments of this DVI port differ from those of the standard DVI interface.



2. Connect and fasten the DB26 end of the LVDS cable onto the LVDS port of the VTC series.











CAUTION: Make sure the power is off for VTC series before connecting VMD 1000/ 2000 with VTC series via the LVDS cable.

If connection between VMD 1000/2000 and VTC series is made while VTC series is already powered on, VTC series will shut down automatically.







Chapter 4: OSD Function

Menu Structure of the Screen Adjustment

Top Menu	Sub Menu							
 Auto Adjust	N/A							
 Luminance	Brightness		Contrast			Exit		
 Geometry	H Position	V Position	Pixel Clock	Phase	Exit			
 Color	9300	6500	5800	User Preset	Exit			
 Volume	N/A							
 OSD	H Position		V Position		OSD Time		Exit	
 Language	English	Francais	Deutsch	Italiano	Espanol	Japanese	Traditional Chinese	Simplified Chinese
 Recall	Color Recall		Recall All			Exit		
 Miscellaneous	Sharpness		Display Information			Exit		
 Exit	N/A							

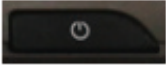
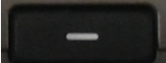
Button Function



Button	Function Description
 Power	Power on / off Launch OSD function (with "Brightness - " button)
 Brightness Minus	Decrease brightness of the display Enter sub menu (in OSD mode)
 Brightness Plus	Increase brightness of the display Adjust parameter with positive value (in the adjusting menu of OSD mode) Switch menu / function (in OSD mode)
 Volume Minus	Decrease volume of the speaker Adjust parameter with negative value (in the adjusting menu of OSD mode)
 Volume Plus	Increase volume of the speaker Escape back to upper menu level / OSD menu (in OSD mode) Launch OSD Function (with "Power" button)

Auto Adjust



Menu	Description
Auto Adjust	Automatically adjusts every parameter

Luminance

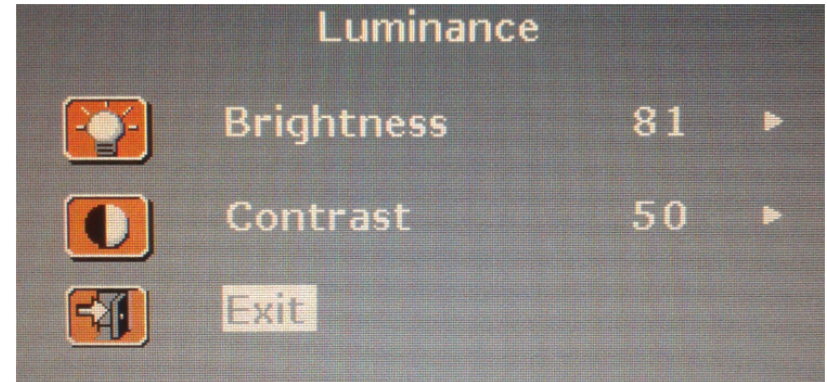

Menu	Description
Brightness	Adjust brightness of the screen
Contrast	Adjust contrast of the screen
Exit	Escape and go back to upper menu level

Geometry

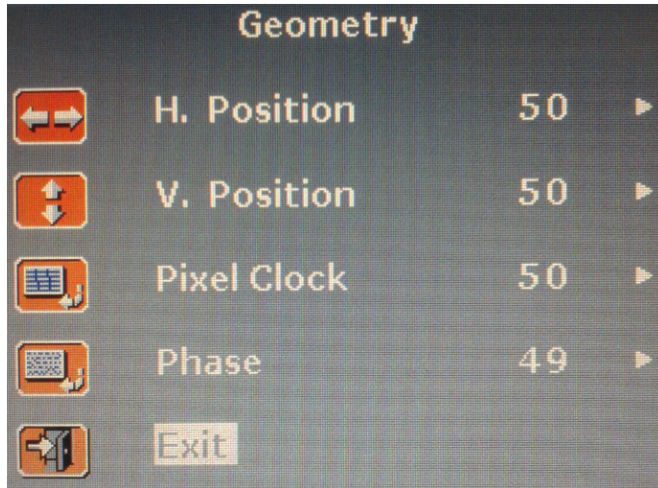

Menu	Description
H Position	Move the position of the display area in horizontal direction This function is only available in analog mode
V Position	Move the position of the display area in vertical direction This function is only available in analog mode
Pixel Clock	Adjust pixel clock
Phase	Adjust pixel phase
Exit	Escape and go back to upper menu level

Color

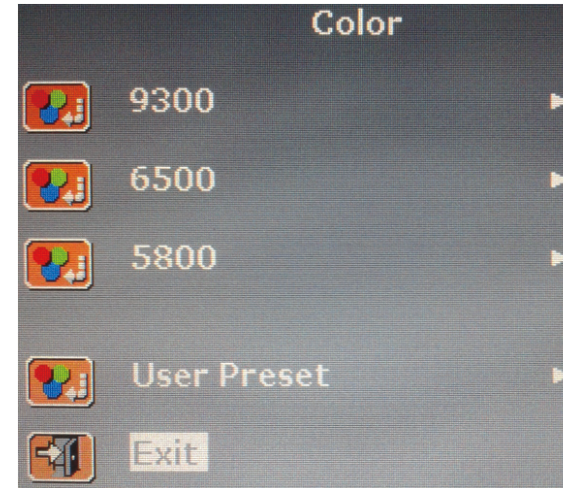

Menu	Description
9300	Set the color temperature of the display to 9300K
6500	Set the color temperature of the display to 6500K
5800	Set the color temperature of the display to 5800K
User Preset	Set the color temperature of the display to User Preset setting
Exit	Escape and go back to upper menu level

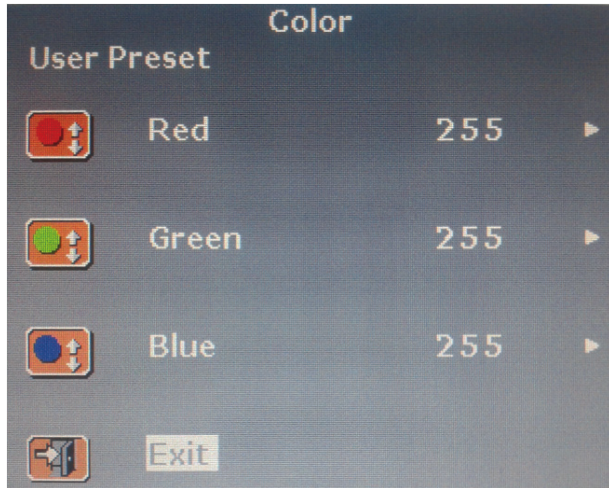

Color - User Preset

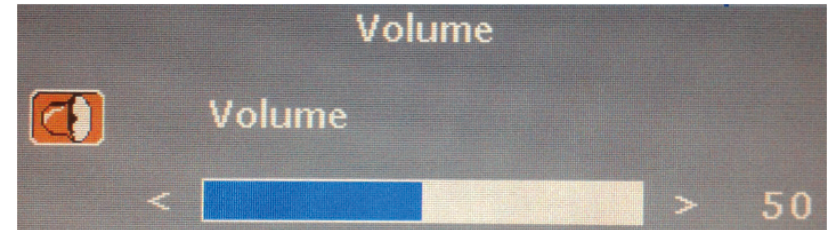

Menu	Description
Red	Adjust the color density of red
Green	Adjust the color density of green
Blue	Adjust the color density of blue
Exit	Escape and go back to upper menu level

Volume



Button	Function Description
 Volume Plus	Increase volume of the speaker
 Volume Minus	Decrease volume of the speaker

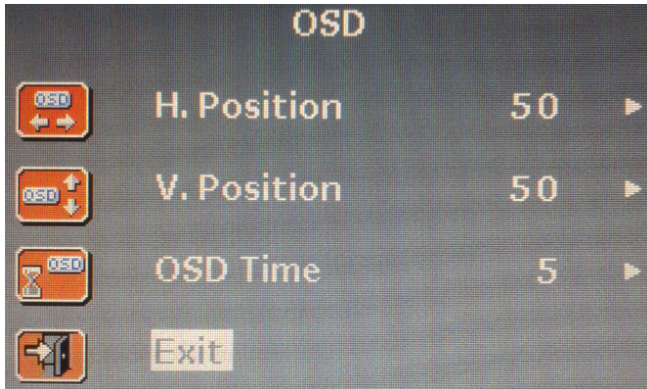

OSD

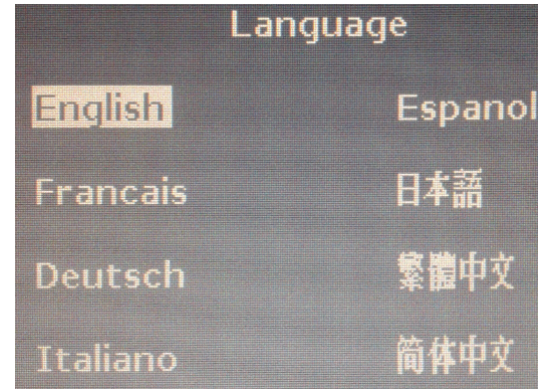

Menu	Description
H Position	Move the position of the OSD Menu in horizontal direction This function is only available in analog mode
V Position	Move the position of the OSD Menu in vertical direction This function is only available in analog mode
OSD Time	Adjust OSD time
Exit	Escape and go back to upper menu level

Language



Menu	Description
 Brightness Plus	Select the language
 Volume Minus	Apply the language

Recall

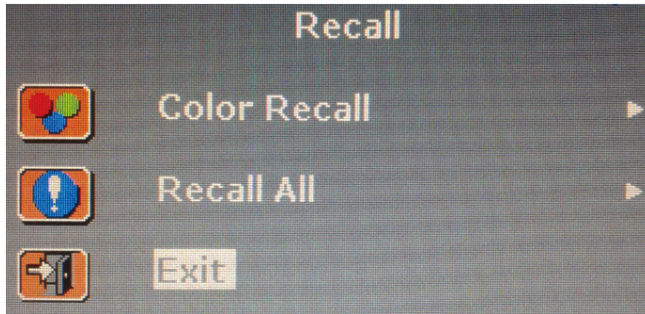

Menu	Description
Color Recall	Recall color parameter to default setting
Recall All	Recall all parameters to default setting
Exit	Escape and go back to upper menu level

Miscellaneous

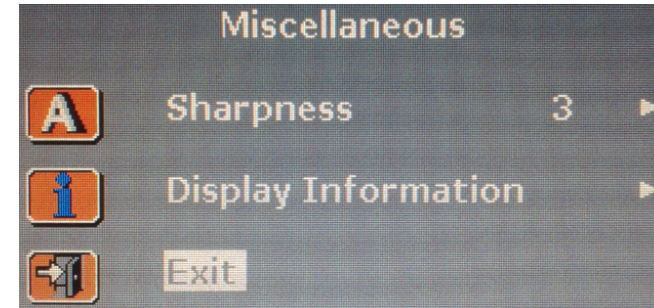

Menu	Description
Sharpness	Adjust sharpness level
Display Information	Show display information (ex. Resolution, V-sync Frequency)
Exit	Escape and go back to upper menu level