

ONYX-2122

21.6" Intel® Core™ 2 Duo
Processor
High Brightness
Slim Medical Panel PC

Copyright Notice

This document is copyrighted, 2010. All rights are reserved. The original manufacturer reserves the right to make improvements to the products described in this manual at any time without notice.

No part of this manual may be reproduced, copied, translated, or transmitted in any form or by any means without the prior written permission of the original manufacturer. Information provided in this manual is intended to be accurate and reliable. However, the original manufacturer assumes no responsibility for its use, nor for any infringements upon the rights of third parties, which may result from its use.

The material in this document is for product information only and is subject to change without notice. While reasonable efforts have been made in the preparation of this document to assure its accuracy, AAEON, assumes no liabilities resulting from errors or omissions in this document, or from the use of the information contained herein.

AAEON reserves the right to make changes in the product design without notice to its users.

Acknowledgments

- Intel[®], Core[™] 2 Duo are registered trademarks of Intel[®] Corporation.
- IBM, PC/AT, PS/2 are trademarks of International Business Machines Corporation.
- Microsoft[®] Windows is a registered trademark of Microsoft[®] Corporation.
- RTL is a trademark of Realtek Semi-Conductor Co., Ltd.
- C&T is a trademark of Chips and Technologies, Inc.
- UMC is a trademark of United Microelectronics Corporation.
- ITE is a trademark of Integrated Technology Express, Inc.

All other product names or trademarks are properties of their respective owners.

Packing List

Before you begin installing your Medical Station, please make sure that the following items have been shipped:

- ONYX-2122 Medical Station
- HDD screws
- Utility CD-ROM

Contains User's Manual (in PDF format), Drivers and Utilities

If any of these items are missing or damaged, you should contact your distributor or sales representative immediately.

AAEON Branches

AAEON Systems, Inc.

2663 Saturn Street, Brea, CA 92821, USA
Toll Free: +1-877-TO-AAEON (1-877-862-2366)
Tel: +1-714-996-1800
Fax: +1-714-996-1811
E-mail: sales@aaeon.com
For System-Level Tech Support (North and South America only)
Tel: +1-714-996-1800 x-111

AAEON Electronics, Inc.

3 Crown Plaza, Hazlet, NJ 07730-2441, USA
Toll Free: +1-888-AAEON-US (1-888-223-6687)
Tel: +1-732-203-9300
Fax: +1-732-203-9311
E-mail: sales@aaeon.com
For Board-Level Tech Support (North and South America only)
Tel: +1-732-203-9300 x-125

AAEON EUROPE

Netherlands

Ekkersrijt 4002, 5692 DA Son, The Netherlands

Tel: +31-(0)499-462020

Fax: +31-(0)499-462010

E-mail: saleseurope@aaeon.com

Germany

AAEON Technology GmbH

An der Trift 65d, D-63303 Dreieich, Germany

Tel: +49(0)61033 74 79 00

Fax: +49(0)61033 74 79 49

E-mail: saleseurope@aaeon.com

Asia

Singapore

AAEON Technology Singapore PTE LTD.

57 Genting Lane, #07-00, Singapore 349564

Tel: +65-6749-8749

Fax: +65-6746-1595

E-mail: sales@aaeon.com.sg

Safety & Warranty

1. Read these safety instructions carefully.
2. Keep this user's manual for later reference.
3. Disconnect this equipment from any AC outlet before cleaning. Do not use liquid or spray detergents for cleaning. Use a damp cloth.
4. For pluggable equipment, the power outlet must be installed near the equipment and must be easily accessible.
5. Keep this equipment away from humidity.
6. Put this equipment on a reliable surface during installation. Dropping it or letting it fall could cause damage.
7. The openings on the enclosure are for air convection. Protect the equipment from overheating. **DO NOT COVER THE OPENINGS.**
- 8. Make sure the voltage of the power source is correct before connecting the equipment to the power outlet.**
9. Position the power cord so that people cannot step on it. Do not place anything over the power cord.
10. All cautions and warnings on the equipment should be noted.
11. If the equipment is not used for a long time, disconnect it from the power source to avoid damage by transient over-voltage.
12. Never pour any liquid into an opening. This could cause fire or electrical shock.
13. Never open the equipment. For safety reasons, only qualified service personnel should open the equipment.

- 14. If any of the following situations arises, get the equipment checked by service personnel:**
- a. The power cord or plug is damaged.
 - b. Liquid has penetrated into the equipment.
 - c. The equipment has been exposed to moisture.
 - d. The equipment does not work well, or you cannot get it to work according to the users manual.
 - e. The equipment has been dropped and damaged.
 - f. The equipment has obvious signs of breakage.
- 15. DO NOT LEAVE THIS EQUIPMENT IN AN UNCONTROLLED ENVIRONMENT WHERE THE STORAGE TEMPERATURE IS BELOW -20° C (-4°F) OR ABOVE 60° C (140° F). IT MAY DAMAGE THE EQUIPMENT.**
- 16. External equipment intended for connection to signal input/output or other connectors, shall comply with relevant UL / IEC standard (e.g. UL 1950 for IT equipment and UL 60601-1 / IEC 60601 series for systems – shall comply with the standard IEC 60601-1-1, Safety requirements for medical electrical systems. Equipment not complying with UL 60601-1 shall be kept outside the patient environment, as defined in the standard.**

Caution:

It may cause the danger of explosion if battery is incorrectly replaced. Replace only with same or equivalent type recommended by the manufacturer.

Classification

1. Degree of protection against electric shock: not classified
2. Degree of protection against the ingress of water: IPX0
3. Equipment not suitable for use in the presence of a flammable anesthetic mixture with air or with oxygen or nitrous oxide.
4. Mode of operation: Continuous
5. Type of protection against electric shock: Class I equipment

FCC

Warning!



This device complies with Part 15 FCC Rules. Operation is subject to the following two conditions: (1) this device may not cause harmful interference, and (2) this device must accept any interference received including interference that may cause undesired operation.





UL Module Description



Onyx-2122 AC modules are developed to suitable for the Classification Mark requirement

Safety Symbol Description

The following safety symbols are the further explanations for your reference.

	<p><i>Medical equipment with respect to electric shock, fire and mechanical hazards only in accordance with UL 60601-1, and CAN/CSA C22.2 NO. 601.1</i></p>
	<p><i>Attention, consult ACCOMPANYING DOCUMENTS.</i></p>
	<p><i>Ground wire Protective Ground wire.</i></p>
	<p><i>Medical equipment with respect to electric shock, fire and mechanical hazards only in accordance with UL 60601-1, and CAN/CSA C22.2 NO. 601.1</i></p>

Below Table for China RoHS Requirements
 产品中有毒有害物质或元素名称及含量
 AAEON Panel PC/ Workstation

部件名称	有毒有害物质或元素					
	铅 (Pb)	汞 (Hg)	镉 (Cd)	六价铬 (Cr(VI))	多溴联苯 (PBB)	多溴二苯醚 (PBDE)
印刷电路板 及其电子组件	×	○	○	○	○	○
外部信号 连接器及线材	×	○	○	○	○	○
外壳	×	○	○	○	○	○
中央处理器 与内存	×	○	○	○	○	○
硬盘	×	○	○	○	○	○
液晶模块	×	○	○	○	○	○
光驱	×	○	○	○	○	○
触控模块	×	○	○	○	○	○
电源	×	○	○	○	○	○
<p>O: 表示该有毒有害物质在该部件所有均质材料中的含量均在 SJ/T 11363-2006 标准规定的限量要求以下。</p> <p>X: 表示该有毒有害物质至少在该部件的某一均质材料中的含量超出 SJ/T 11363-2006 标准规定的限量要求。</p> <p>备注： 一、此产品所标示之环保使用期限，系指在一般正常使用状况下。 二、上述部件物质中央处理器、内存、硬盘、光驱、触控模块为选购品。</p>						

Contents

Chapter 1 General Information

1.1 Introduction.....	1-2
1.2 Features	1-3
1.3 Specification	1-4
1.4 Dimension	1-8

Chapter 2 Hardware Installation

2.1 Safety Precautions	2-2
2.2 A Quick Tour of the ONYX-2122.....	2-3
2.3 Removing the rear maintenance cover	2-4
2.4 2.5" Hard Disk Drive (HDD) Installation	2-4

Chapter 3 Award BIOS Setup

3.1 System Test and Initialization	3-2
3.2 Award BIOS Setup.	3-3

Chapter 4 Driver Installation

4.1 Installation	4-3
------------------------	-----

Appendix A Programming the Watchdog Timer

A.1 Programming	A-2
A.2 ITE8712 Watchdog Timer Initial Program.....	A-5

Appendix B I/O Information

B.1 I/O Address Map.....	B-2
--------------------------	-----

B.2 Memory Address Map.....B-2
B.3 IRQ Mapping ChartB-3
B.4 DMA Channel Assignments.....B-5

Appendix C Miscellanea

C.1 General Cleaning Tips..... C-2
C.2 Cleaning Tools..... C-3
C.3 Scrap Computer Recycling C-5

Chapter

1

**General
Information**

1.1 Introduction

The ONYX-2122 is a Slim Medical Panel PC with Intel® Core™ 2 Duo ULV processor-based computer that is designed to serve as a point of care station. It is a PC-based system with 21.6" true color TFT LCD display, Zero Noise solution, integrated multimedia functions make them the perfect platforms to build comprehensive lifestyle computing applications.

The ONYX-2122 includes all the features of a powerful computer into a slim and attractive chassis. The ONYX-2122 has 300 nits TFT displays with Full HD 1920 x 1080 resolution. Integrating with high brightness LCD is easier to analyze DICOM images. It supports 2.5" Hard Disk Drive storage function and one Mini-PCI for WLAN expansion. Moreover, they feature flexible I/O ports, such as four USB2.0, one RS-232 and two optional isolated COM, one 10/100/1000Base-TX, one PS/2 keyboard/ mouse, and two speakers.

Convenient operation, Silent, compact, mobility and highly integrated multimedia system let you to focus on healthcare utility, interactive information displays, automation control systems, general desktop usage, multimedia recreation, and other medical requirements.

1.2 Features

- 21.6" Full HD Resolution LCD
- Easy To Use, Compact, Simple Design
- Fanless, Zero Noise
- High Contrast Ratio, Wide Viewing Angle For Medical Imaging
- Intel® Core™ 2 Duo ULV Processor\
- Resistive Touchscreen (Optional)
- 802.11a/b/g/n Wireless Antenna (Optional)
- USB & COM Isolation (Optional)
- Weight: 6.9 Kg, Thickness: 65mm

1.3 Specification

Hardware Specifications

Display	ONYX-2122: 21.6" SXGA color TFT LCD
System Memory	200-pin DDRII SODIMM x 1, Max. 2GB
CPU Board	Intel® Core™ 2 Duo U series Processor
Drive Bay	2.5" Hard Disk Drive (optional)
Expansion	Mini-PCI x 1
Button	Brightness: "+" / "-"; Sound: "+" / "-"; Power SW
I/O	RS-232 x 1, COM isolation x 2 (optional) USB 2.0 x 4, USB isolation x 1 (optional) 10/100/1000 Base-TX x 1 PS/2 keyboard/ mouse x 1 Speaker x 2 (2W)

LCD Specifications

Model Name	ONYX-2122
Display Type	21.6" color TFT LCD
Max. Resolution	Full HD 1920 x 1080
Max. Colors	16.7M
Dot Size (mm)	0.297 x 0.297
Luminance (cd/m2)	300 (TYP)
Viewing Angle	170° (H)
	160° (V)

Contrast Ratio	1000 : 1
Brightness Control	Yes
Back Light MTBF	50,000 Hrs

Note: All AAEON's LCD products are manufactured with High precision technology. However, there are a small number of defective pixels in all LCD panels that are not able to change color. This is a normal occurrence for all LCD displays from all manufacturers and should not be noticeable or objectionable under normal operation. AAEON LCD panels are qualified for industry standard conditions in the following: total 7 dead pixels on a screen or if there are 3 within 1 inch square area of each other on the display.

Mechanical Specifications

Architecture	Close-frame
Front Bezel	Plastic bezel with resistive touch screen
Color	White
Mounting / Holder	VESA 75/100mm
Construction	3mm ABS + PC TYPE Plastic housing
Dimension (W x H x D)	ONYX-2122: 21.5" x 21.7" x 2.8" (546mm x 551.4mm x 70mm)
Carton Dimension	23.8" x 9.1" x 24" (605mm x 230mm x 610mm)
Net Weight	ONYX-2122: 15.18 lb (6.9 kg)
Gross Weight	ONYX-2122: 24.2 lb (11 kg)
Packing Filler	PE

Power Supply Specifications

Power Requirement	DC 9~30V
Input Voltage	100 ~ 240V AC @ 47~ 63Hz, 1.4 ~0.6A

Output Voltages	24V, 5A, 120W Max.
MTBF	100,000 hrs operation at 25°C

Environmental Specifications

Operating Temperature	0°C to 40°C (32°F ~104°F)
Storage Temperature	-20°C to 60°C (-4°F ~140°F)
Storage Humidity	5% to 95%@ 40°C, non-condensing
Vibration	0.5G / 5 ~ 500Hz (Random) / operation
Shock	15G peak acceleration (11 msec. duration) / operation
Drop	76cm (1 Corner, 3 Edge, 6 Surface)
EMI / Safety	CE / FCC Class B/ UL 60601-1/ EN 60601-1
IP	Front bezel, IP-65 compliant
Noise	Zero noise
Input Power Rating	100~240V/47~63Hz, 1.4~0.6A

TouchScreen (Optional)

Type	5-wire, Analog Resistive
Interface	USB Interface
Resolution	2048 x 2048
Light Transmission	> 80% ± 2%
Life Time	35 million times

1.4 Dimension

UNIT : mm

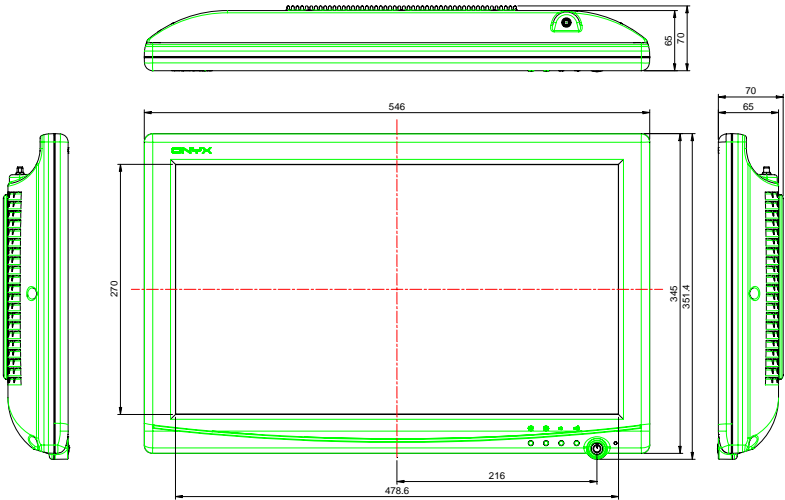

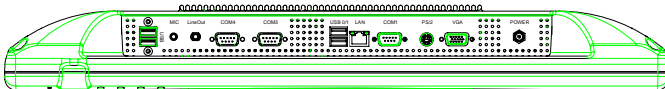
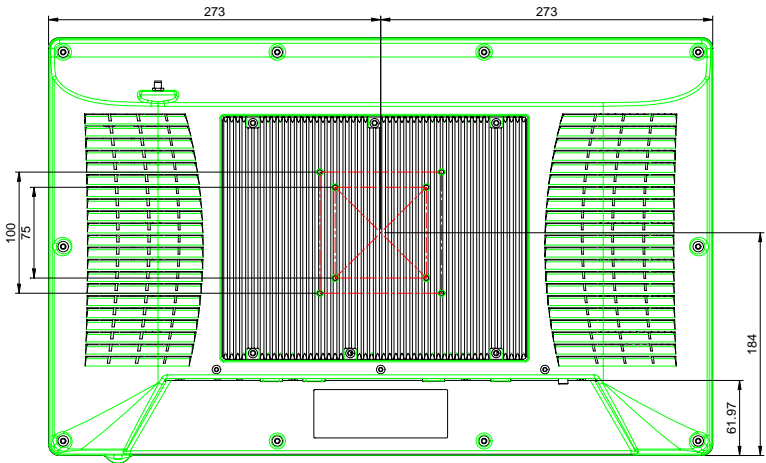
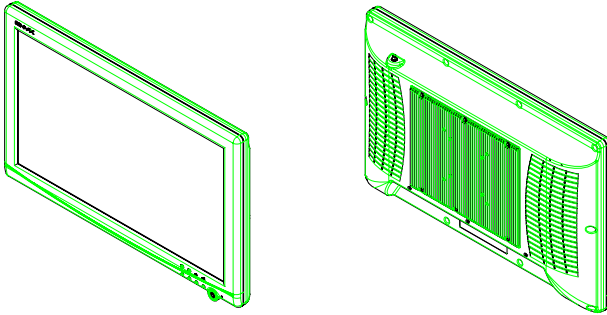

Chapter

2

**Hardware
Installation**

2.1 Safety Precautions

Warning!

Always completely disconnect the power cord from your board whenever you are working on it. Do not make connections while the power is on, because a sudden rush of power can damage sensitive electronic components.

Caution!

Always ground yourself to remove any static charge before touching the board. Modern electronic devices are very sensitive to static electric charges. Use a grounding wrist strap at all times. Place all electronic components on a static-dissipative surface or in a static-shielded bag when they are not in the chassis

2.2 A Quick Tour of the ONYX-2122

Before you start to set up the ONYX-2122, take a moment to become familiar with the locations and purposes of the controls, drives, connections and ports, which are illustrated in the figures below.

When you place the ONYX-2122 upright on the desktop, its front panel appears as shown in Picture 2-1.



Picture 2-1: Front View of the Medical Station

When you turn the Medical Station around and look at its rear cover, the sunken I/O section is at the bottom of the station, as shown in Picture 2-2. (The I/O section includes various I/O ports, including DC-in, Serial ports, VGA, PS2, Ethernet, USB.) Only assemble with the Mini PCI capture card; the S-Video in function will work. The medical Station integrates with WLAN function by using Mini PCI.



Figure 2.2: Rear view of the Medical Station

2.3 Removing the rear maintenance cover

Pull USB cover; Unscrew the attachment screws used to hold the rear maintenance cover and remove rear cover.

2.4 2.5" Hard Disk Drive (HDD) Installation

1. Unscrew the rear cover screws.

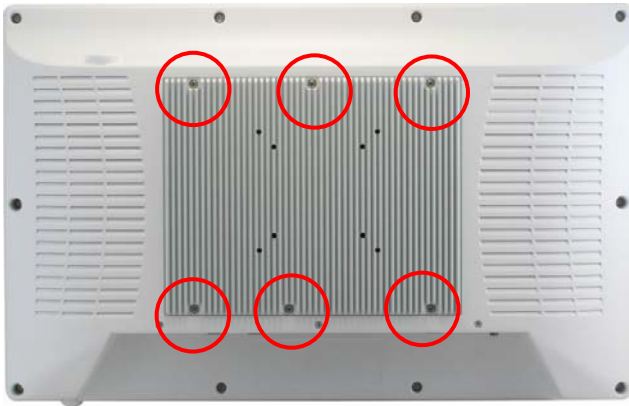

2. Remove rear cover and unscrew the disk module screws.

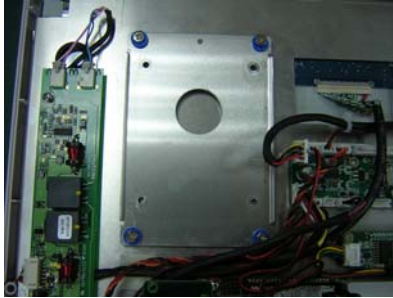

3. Assemble 2.5" HDD into disk module.

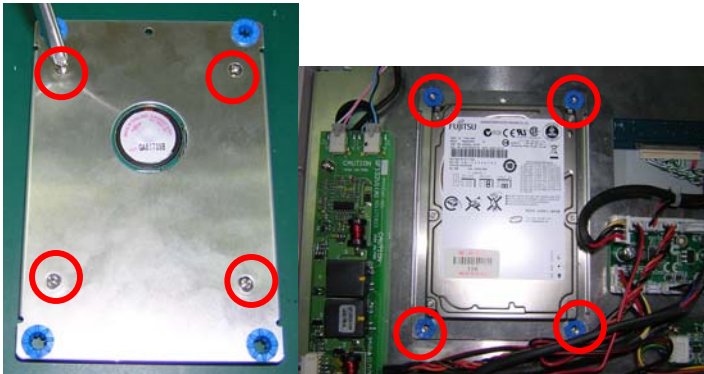

4. Connect HDD cable to 2.5" HDD connector



Chapter

3

**Award
BIOS Setup**

3.1 System Test and Initialization

These routines test and initialize board hardware. If the routines encounter an error during the tests, you will either hear a few short beeps or see an error message on the screen. There are two kinds of errors: fatal and non-fatal. The system can usually continue the boot up sequence with non-fatal errors. Non-fatal error messages usually appear on the screen along with the following instructions:

Press <F1> to RESUME

Write down the message and press the F1 key to continue the boot up sequence.

System configuration verification

These routines check the current system configuration against the values stored in the CMOS memory. If they do not match, the program outputs an error message. You will then need to run the BIOS setup program to set the configuration information in memory.

There are three situations in which you will need to change the CMOS settings:

1. You are starting your system for the first time
2. You have changed the hardware attached to your system
3. The CMOS memory has lost power and the configuration information has been erased.

The ONYX-2122 CMOS memory has an integral lithium battery backup for data retention. However, you will need to replace the complete unit when it finally runs down.

3.2 Award BIOS Setup

Awards BIOS ROM has a built-in Setup program that allows users to modify the basic system configuration. This type of information is stored in battery-backed CMOS RAM so that it retains the Setup information when the power is turned off.

Entering setup

Power on the computer and press immediately. This will allow you to enter Setup.

Standard CMOS Features

Use this menu for basic system configuration. (Date, time, IDE, etc.)

Advanced BIOS Features

Use this menu to set the advanced features available on your system.

Advanced Chipset Features

Use this menu to change the values in the chipset registers and optimize your system performance.

Integrated Peripherals

Use this menu to specify your settings for integrated peripherals. (Primary slave, secondary slave, keyboard, mouse etc.)

Power Management Setup

Use this menu to specify your settings for power management. (HDD power down, power on by ring etc.)

PnP/PCI Configurations

This entry appears if your system supports PnP/PCI.

PC Health Status

This menu shows you the status of PC.

Frequency/Voltage Control

This menu shows you the display of frequency/Voltage Control.

Load Fail-Safe Defaults

Use this menu to load the BIOS default values for the minimal/stable performance for your system to operate.

Load Optimized Defaults

Use this menu to load the BIOS default values that are factory settings for optimal performance system operations. While AWARD has designated the custom BIOS to maximize performance, the factory has the right to change these defaults to meet their needs.

Set Supervisor/User Password

Use this menu to set Supervisor/User Passwords.

Save and Exit Setup

Save CMOS value changes to CMOS and exit setup.

Exit Without Saving

Abandon all CMOS value changes and exit setup.

For more detailed information, you can refer to the "AAEON BIOS Item Description.pdf" file in the CD for the meaning of each setting in this chapter.

Chapter

4

**Driver
Installation**

The ONYX-2122 comes with an AutoRun CD-ROM that contains all drivers and utilities that can help you to install the driver automatically.

Insert the driver CD, the driver CD-title will auto start and show the installation guide. If not, please follow the sequence below to install the drivers.

Follow the sequence below to install the drivers:

Step 1 – Install Intel[®] INF Driver

Step 2 – Install Intel[®] VGA Driver

Step 3 – Install Intel[®] LAN Driver

Step 4 – Install Realtek Audio Driver

Step 5 – Install Touch Driver

USB 2.0 Drivers are available for download using Windows[®] Update for both Windows[®] XP and Windows[®] 2000. For additional information regarding USB 2.0 support in Windows[®] XP and Windows[®] 2000, please visit www.microsoft.com/hwdev/usb/.

Please read instructions below for further detailed installations.

4.1 Installation:

Insert the ONYX-2122 CD-ROM into the CD-ROM drive. And install the drivers from Step 1 to Step 5 in order.

Step 1 – Install Intel® INF Driver

1. Click on the **Step 1 – Intel Inf Driver** folder and double click on the **Setup.exe**
2. Follow the instructions that the window shows
3. The system will help you install the driver automatically

Step 2 – Install Intel® VGA Driver

1. Click on the **Step 2 – Intel VGA Driver** folder and select the OS folder your system is
2. Double click on the **.exe** file located in the OS folder
3. Follow the instructions that the window shows
4. The system will help you install the driver automatically

Step 3 – Install Intel® LAN Driver

1. Click on the **Step 3 – Intel LAN Driver** folder and select the OS folder your system is
2. Double click on the **.exe** file located in the OS folder
3. Follow the instructions that the window shows
4. The system will help you install the driver automatically

Step 4 –Install Realtek Audio Driver

1. Click on the **Step 4 – Realtek Audio Driver** folder and select the OS folder your system is
2. Double click on the **setup.exe** file located in the OS folder
3. Follow the instructions that the window shows
4. The system will help you install the driver automatically

Step 5 – Install Touch Panel Driver

1. Click on the **Step 5-Touch** folder and select the folder of **All_In_One_2k_XP_Vista_5.0.1.5310_Release**
2. Double click on the **setup.exe**
3. Follow the instructions that the window shows
4. The system will help you install the driver automatically

Appendix

A

Programming the Watchdog Timer

A.1 Programming

ONYX-2122 utilizes ITE 8712 chipset as its watchdog timer controller. Below are the procedures to complete its configuration and the AAEON initial watchdog timer program is also attached based on which you can develop customized program to fit your application.

Configuring Sequence Description

After the hardware reset or power-on reset, the ITE 8712 enters the normal mode with all logical devices disabled except KBC. The initial state (enable bit) of this logical device (KBC) is determined by the state of pin 121 (DTR1#) at the falling edge of the system reset during power-on reset.

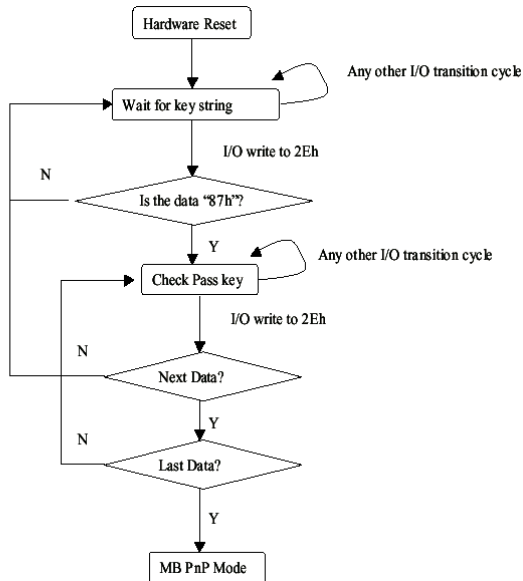

There are three steps to complete the configuration setup: (1) Enter the MB PnP Mode; (2) Modify the data of configuration registers; (3) Exit the MB PnP Mode. Undesired result may occur if the MB PnP Mode is not exited normally.

(1) Enter the MB PnP Mode

To enter the MB PnP Mode, four special I/O write operations are to be performed during Wait for Key state. To ensure the initial state of the key-check logic, it is necessary to perform four write operations to the Special Address port (2EH). Two different enter keys are provided to select configuration ports (2Eh/2Fh) of the next step

	Address Port	Data Port
87h, 01h, 55h, 55h:	2Eh	2Fh

(2) Modify the Data of the Registers

All configuration registers can be accessed after entering the MB PnP Mode. Before accessing a selected register, the content of Index 07h must be changed to the LDN to which the register belongs, except some Global registers.

(3) Exit the MB PnP Mode

Set bit 1 of the configure control register (Index=02h) to 1 to exit the MB PnP Mode.

WatchDog Timer Configuration Registers

LDN	Index	R/W	Reset	Configuration Register or Action
All	02H	W	N/A	Configure Control
07H	71H	R/W	00H	WatchDog Timer Control Register
07H	72H	R/W	00H	WatchDog Timer Configuration Register
07H	73H	R/W	00H	WatchDog Timer Time-out Value Register

Configure Control (Index=02h)

This register is write only. Its values are not sticky; that is to say, a hardware reset will automatically clear the bits, and does not require the software to clear them.

Bit	Description
7-2	Reserved
1	Returns to the Wait for Key state. This bit is used when the configuration sequence is completed
0	Resets all logical devices and restores configuration registers to their power-on states.

WatchDog Timer Control Register (Index=71h, Default=00h)

Bit	Description
7	WDT is reset upon a CIR interrupt
6	WDT is reset upon a KBC (mouse) interrupt
5	WDT is reset upon a KBC (keyboard) interrupt
4	WDT is reset upon a read or a write to the Game Port base address
3-2	Reserved
1	Force Time-out. This bit is self-clearing
0	WDT Status 1: WDT value reaches 0. 0: WDT value is not 0

WatchDog Timer Configuration Register (Index=72h, Default=0)

Bit	Description
7	WDT Time-out value select 1: Second 0: Minute
6	WDT output through KRST (pulse) enable
5-4	Reserved
3-0	Select the interrupt level ^{Note} for WDT

WatchDog Timer Time-out Value Register (Index=73h, Default=00h)

Bit	Description
7-0	WDT Time-out value 7-0

A.2 ITE8712 Watchdog Timer Initial Program

```
.MODEL SMALL
```

```
.CODE
```

Main:

```
CALL Enter_Configuration_mode
```

```
CALL Check_Chip
```

```
mov cl, 7
```

```
call Set_Logic_Device
```

```
;time setting
```

```
mov cl, 10 ; 10 Sec
```

```
dec al
```

Watch_Dog_Setting:

```
;Timer setting
```

```
mov al, cl
```

```
mov cl, 73h
```

```
call Superio_Set_Reg
```

```
;Clear by keyboard or mouse interrupt
```

```
mov al, 0f0h
```

```
mov cl, 71h
```

```
call Superio_Set_Reg
```

```
;unit is second.
```

```
mov al, 0C0H
```

```
mov cl, 72h
```

```
call Superio_Set_Reg
```

```
; game port enable  
mov cl, 9  
call Set_Logic_Device
```

```
Initial_OK:  
CALL Exit_Configuration_mode  
MOV AH,4Ch  
INT 21h
```

```
Enter_Configuration_Mode PROC NEAR  
MOV SI,WORD PTR CS:[Offset Cfg_Port]
```

```
MOV DX,02Eh  
MOV CX,04h  
Init_1:  
MOV AL,BYTE PTR CS:[SI]  
OUT DX,AL  
INC SI  
LOOP Init_1  
RET  
Enter_Configuration_Mode ENDP
```

```
Exit_Configuration_Mode PROC NEAR  
MOV AX,0202h  
CALL Write_Configuration_Data
```

RET

Exit_Configuration_Mode ENDP

Check_Chip PROC NEAR

MOV AL,20h

CALL Read_Configuration_Data

CMP AL,87h

JNE Not_Initial

MOV AL,21h

CALL Read_Configuration_Data

CMP AL,12h

JNE Not_Initial

Need_Initial:

STC

RET

Not_Initial:

CLC

RET

Check_Chip ENDP

Read_Configuration_Data PROC NEAR

MOV DX,WORD PTR CS:[Cfg_Port+04h]

OUT DX,AL

```
MOV DX,WORD PTR CS:[Cfg_Port+06h]
IN AL,DX
RET
Read_Configuration_Data ENDP
```

```
Write_Configuration_Data PROC NEAR
MOV DX,WORD PTR CS:[Cfg_Port+04h]
OUT DX,AL
XCHG AL,AH
MOV DX,WORD PTR CS:[Cfg_Port+06h]
OUT DX,AL
RET
Write_Configuration_Data ENDP
```

```
Superio_Set_Reg proc near
push ax
MOV DX,WORD PTR CS:[Cfg_Port+04h]
mov al,cl
out dx,al
pop ax
inc dx
out dx,al
ret
Superio_Set_Reg endp.Set_Logic_Device proc near
```

```
Set_Logic_Device proc near
push ax
push cx
xchg al,cl
mov cl,07h
call Superio_Set_Reg
pop cx
pop ax
ret
Set_Logic_Device endp
```

```
;Select 02Eh->Index Port, 02Fh->Data Port
Cfg_Port DB 087h,001h,055h,055h
DW 02Eh,02Fh
```

END Main

Note: Interrupt level mapping

0Fh-Dh: not valid

0Ch: IRQ12

.

.

03h: IRQ3

02h: not valid

01h: IRQ1

00h: no interrupt selected

Appendix

B

I/O Information

B.1 I/O Address Map

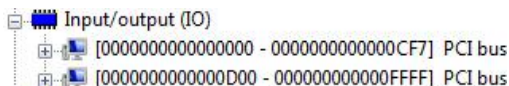



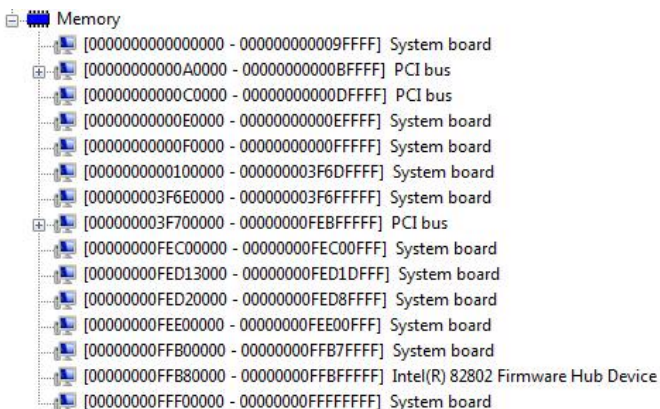

















































B.2 Memory Address Map





B.3 IRQ Mapping Chart

Interrupt request (IRQ)	
(ISA) 0	System timer
(ISA) 3	Communications Port (COM1)
(ISA) 4	Communications Port (COM3)
(ISA) 8	System CMOS/real time clock
(ISA) 10	Communications Port (COM3)
(ISA) 10	Communications Port (COM5)
(ISA) 100	Microsoft ACPI-Compliant System
(ISA) 101	Microsoft ACPI-Compliant System
(ISA) 102	Microsoft ACPI-Compliant System
(ISA) 103	Microsoft ACPI-Compliant System
(ISA) 104	Microsoft ACPI-Compliant System
(ISA) 105	Microsoft ACPI-Compliant System
(ISA) 106	Microsoft ACPI-Compliant System
(ISA) 107	Microsoft ACPI-Compliant System
(ISA) 108	Microsoft ACPI-Compliant System
(ISA) 109	Microsoft ACPI-Compliant System
(ISA) 11	Communications Port (COM4)
(ISA) 11	Communications Port (COM6)
(ISA) 110	Microsoft ACPI-Compliant System
(ISA) 111	Microsoft ACPI-Compliant System
(ISA) 112	Microsoft ACPI-Compliant System
(ISA) 113	Microsoft ACPI-Compliant System
(ISA) 114	Microsoft ACPI-Compliant System
(ISA) 115	Microsoft ACPI-Compliant System
(ISA) 116	Microsoft ACPI-Compliant System
(ISA) 117	Microsoft ACPI-Compliant System
(ISA) 118	Microsoft ACPI-Compliant System
(ISA) 119	Microsoft ACPI-Compliant System
(ISA) 120	Microsoft ACPI-Compliant System
(ISA) 121	Microsoft ACPI-Compliant System
(ISA) 122	Microsoft ACPI-Compliant System
(ISA) 123	Microsoft ACPI-Compliant System
(ISA) 124	Microsoft ACPI-Compliant System
(ISA) 125	Microsoft ACPI-Compliant System
(ISA) 126	Microsoft ACPI-Compliant System
(ISA) 127	Microsoft ACPI-Compliant System
(ISA) 128	Microsoft ACPI-Compliant System
(ISA) 129	Microsoft ACPI-Compliant System
(ISA) 13	Numeric data processor
(ISA) 130	Microsoft ACPI-Compliant System
(ISA) 131	Microsoft ACPI-Compliant System
(ISA) 132	Microsoft ACPI-Compliant System
(ISA) 133	Microsoft ACPI-Compliant System
(ISA) 134	Microsoft ACPI-Compliant System

	(ISA) 135	Microsoft ACPI-Compliant System
	(ISA) 136	Microsoft ACPI-Compliant System
	(ISA) 137	Microsoft ACPI-Compliant System
	(ISA) 138	Microsoft ACPI-Compliant System
	(ISA) 139	Microsoft ACPI-Compliant System
	(ISA) 14	ATA Channel 0
	(ISA) 140	Microsoft ACPI-Compliant System
	(ISA) 141	Microsoft ACPI-Compliant System
	(ISA) 142	Microsoft ACPI-Compliant System
	(ISA) 143	Microsoft ACPI-Compliant System
	(ISA) 144	Microsoft ACPI-Compliant System
	(ISA) 145	Microsoft ACPI-Compliant System
	(ISA) 146	Microsoft ACPI-Compliant System
	(ISA) 147	Microsoft ACPI-Compliant System
	(ISA) 148	Microsoft ACPI-Compliant System
	(ISA) 149	Microsoft ACPI-Compliant System
	(ISA) 150	Microsoft ACPI-Compliant System
	(ISA) 151	Microsoft ACPI-Compliant System
	(ISA) 152	Microsoft ACPI-Compliant System
	(ISA) 153	Microsoft ACPI-Compliant System
	(ISA) 154	Microsoft ACPI-Compliant System
	(ISA) 155	Microsoft ACPI-Compliant System
	(ISA) 156	Microsoft ACPI-Compliant System
	(ISA) 157	Microsoft ACPI-Compliant System
	(ISA) 158	Microsoft ACPI-Compliant System
	(ISA) 159	Microsoft ACPI-Compliant System
	(ISA) 160	Microsoft ACPI-Compliant System
	(ISA) 161	Microsoft ACPI-Compliant System
	(ISA) 162	Microsoft ACPI-Compliant System
	(ISA) 163	Microsoft ACPI-Compliant System
	(ISA) 164	Microsoft ACPI-Compliant System
	(ISA) 165	Microsoft ACPI-Compliant System
	(ISA) 166	Microsoft ACPI-Compliant System
	(ISA) 167	Microsoft ACPI-Compliant System
	(ISA) 168	Microsoft ACPI-Compliant System
	(ISA) 169	Microsoft ACPI-Compliant System
	(ISA) 170	Microsoft ACPI-Compliant System
	(ISA) 171	Microsoft ACPI-Compliant System
	(ISA) 172	Microsoft ACPI-Compliant System
	(ISA) 173	Microsoft ACPI-Compliant System
	(ISA) 174	Microsoft ACPI-Compliant System
	(ISA) 175	Microsoft ACPI-Compliant System
	(ISA) 176	Microsoft ACPI-Compliant System
	(ISA) 177	Microsoft ACPI-Compliant System
	(ISA) 178	Microsoft ACPI-Compliant System
	(ISA) 179	Microsoft ACPI-Compliant System
	(ISA) 180	Microsoft ACPI-Compliant System
	(ISA) 181	Microsoft ACPI-Compliant System
	(ISA) 182	Microsoft ACPI-Compliant System
	(ISA) 183	Microsoft ACPI-Compliant System
	(ISA) 184	Microsoft ACPI-Compliant System
	(ISA) 185	Microsoft ACPI-Compliant System
	(ISA) 186	Microsoft ACPI-Compliant System

(ISA) 187	Microsoft ACPI-Compliant System
(ISA) 188	Microsoft ACPI-Compliant System
(ISA) 189	Microsoft ACPI-Compliant System
(ISA) 190	Microsoft ACPI-Compliant System
(ISA) 81	Microsoft ACPI-Compliant System
(ISA) 82	Microsoft ACPI-Compliant System
(ISA) 83	Microsoft ACPI-Compliant System
(ISA) 84	Microsoft ACPI-Compliant System
(ISA) 85	Microsoft ACPI-Compliant System
(ISA) 86	Microsoft ACPI-Compliant System
(ISA) 87	Microsoft ACPI-Compliant System
(ISA) 88	Microsoft ACPI-Compliant System
(ISA) 89	Microsoft ACPI-Compliant System
(ISA) 90	Microsoft ACPI-Compliant System
(ISA) 91	Microsoft ACPI-Compliant System
(ISA) 92	Microsoft ACPI-Compliant System
(ISA) 93	Microsoft ACPI-Compliant System
(ISA) 94	Microsoft ACPI-Compliant System
(ISA) 95	Microsoft ACPI-Compliant System
(ISA) 96	Microsoft ACPI-Compliant System
(ISA) 97	Microsoft ACPI-Compliant System
(ISA) 98	Microsoft ACPI-Compliant System
(ISA) 99	Microsoft ACPI-Compliant System
(PCI) 15	Intel(R) 82801G (ICH7 Family) SMBus Controller - 27DA
(PCI) 16	Intel(R) 82801G (ICH7 Family) PCI Express Root Port - 27D0
(PCI) 16	Intel(R) 82801G (ICH7 Family) USB Universal Host Controller - 27C8
(PCI) 16	Mobile Intel(R) 945 Express Chipset Family
(PCI) 17	Realtek AC'97 Audio
(PCI) 18	Intel(R) 82801G (ICH7 Family) USB Universal Host Controller - 27CA
(PCI) 19	Intel(R) 82801G (ICH7 Family) USB Universal Host Controller - 27C9
(PCI) 19	Intel(R) 82801GBM/GHM (ICH7-M Family) Serial ATA Storage Controller - 27C4
(PCI) -2	Intel(R) PRO/1000 PL Network Connection
(PCI) 23	Intel(R) 82801G (ICH7 Family) USB Universal Host Controller - 27C8
(PCI) 23	Intel(R) 82801G (ICH7 Family) USB2 Enhanced Host Controller - 27CC

B.4 DMA Channel Assignments

	Direct memory access (DMA)
	4 Direct memory access controller

Appendix

C

Miscellanea

C.1 General Cleaning Tips

You may need the following precautions before you begin to clean the computer. When you clean any single part or component for the computer, please read and understand the details below fully.

1. Never spray or squirt the liquids directly onto any computer component. If you need to clean the device, please rub it with a piece of dry cloth.
2. Be cautious of the tiny removable components when you use a vacuum cleaner to absorb the dirt on the floor.
3. Turn the system off before you start to clean up the component or computer.
4. Never drop the components inside the computer or get circuit board damp or wet.
5. Be cautious of all kinds of cleaning solvents or chemicals when you use it for the sake of cleaning. Some individuals may be allergic to the ingredients.
6. Try not to put any food, drink or cigarette around the computer.

C.2 Cleaning tools

Although many companies have created products to help improve the process of cleaning your computer and peripherals users can also use household items to clean their computers and peripherals. Below is a listing of items you may need or want to use while cleaning your computer or computer peripherals.

Keep in mind that some components in your computer may only be able to be cleaned using a product designed for cleaning that component, if this is the case it will be mentioned in the cleaning tips.

- **Cloth** - A piece of cloth is the best tool to use when rubbing up a component. Although paper towels or tissues can be used on most hardware as well, we still recommend you to rub it with a piece of cloth.
- **Water or rubbing alcohol** – You may moisten a piece of cloth a bit with some water or rubbing alcohol and rub it on the computer. Unknown solvents may be harmful to the plastics parts.
- **Vacuum cleaner** - Absorb the dust, dirt, hair, cigarette particles, and other particles out of a computer can be one of the best methods of cleaning a computer. Over time these items can restrict the airflow in a computer and cause circuitry to corrode.

- **Cotton swabs** - Cotton swabs moistened with rubbing alcohol or water are excellent tools for wiping hard to reach areas in your keyboard, mouse, and other locations.
- **Foam swabs** - Whenever possible it is better to use lint free swabs such as foam swabs.

Note:

We strongly recommended that you should shut down the system before you start to clean any single components.

Please follow the steps below.

1. Close all application programs
2. Close operating software
3. Turn off power switch
4. Remove all device
5. Pull out power cable

C.3 Scrap Computer Recycling

If the computer equipments need the maintenance or are beyond repair, we strongly recommended that you should inform us as soon as possible for the suitable solution. For the computers that are no longer useful or work well, please contact with worldwide distributors for recycling.

The worldwide distributors show on the following website:

<http://www.aaeon.com/?TabIndex=Contact&TabID=Distributors>

Note:

Follow the national requirements to dispose unit