

MIC-3358

**6U CompactPCI Intel®
Pentium® 4 Processor - M
Single Board Computer with
VGA / Dual Giga LAN / PMC**

User's Manual

Copyright Notice

This document is copyrighted, 2004. All rights are reserved. The original manufacturer reserves the right to make improvements to the products described in this manual at any time without notice. No part of this manual may be reproduced, copied, translated or transmitted in any form or by any means without the prior written permission of the original manufacturer. Information provided in this manual is intended to be accurate and reliable. However, the original manufacturer assumes no responsibility for its use, nor for any infringements upon the rights of third parties which may result from its use.

Acknowledgements

Award is a trademark of Award Software International, Inc.

IBM, PS/2, OS/2, and VGA are trademarks of International Business Machines Corporation.

Intel® and Pentium® are trademarks of Intel Corporation.

Windows is a registered trademark of Microsoft Corporation.

NetWare is a trademark of Novell, Inc.

PICMG™, CompactPCI™ and the PICMG™, and CompactPCI™ logos are trademarks of the PCI Industrial Computers Manufacturers Group.

All other product names or trademarks are properties of their respective owners.

Technical Support and Sales Assistance

If you have any technical questions about the MIC-3358 or any other Advantech products, please visit our support website at:

<http://support.advantech.com.tw>

For more information about Advantech's products and sales information, please visit:

<http://www.advantech.com>.

Part No.2002335800

Printed in Taiwan

2nd Edition

December 2004

CE Notification

The MIC-3358, developed by Advantech CO., LTD., has passed the CE test for environment specification when shielded cables are used for external wiring. We recommend the use of shielded cables.

FCC

This device complies with the requirements in part 15 of the FCC rule. Operation is subject to the following two conditions:

- (1) This device must not cause harmful interference.
- (2) This device must accept any interference received, including interference that may cause undesired operation.

Product warranty

Advantech warrants to you, the original purchaser, that each of its products will be free from defects in materials and workmanship for one year from the date of purchase. This warranty does not apply to any products which have been repaired or altered by persons other than repair personnel authorized by Advantech, or which have been subject to misuse, abuse, accident or improper installation. Advantech assumes no liability under the terms of this warranty as a consequence of such events.

Because of Advantech's high quality-control standards and rigorous testing, most of our customers never need to use our repair service. If an Advantech product is defective, it will be repaired or replaced at no charge during the warranty period. For out-of-warranty repairs, you will be billed according to the cost of replacement materials, service time and freight. Please consult your dealer for more details.

If you think you have a defective product, follow these steps:

1. Collect all the information about the problem encountered. (For example, CPU speed, Advantech products used, other hardware and software used, etc.) Note anything abnormal and list any on-screen messages you get when the problem occurs.
2. Call your dealer and describe the problem. Please have your manual, product, and any helpful information readily available.
3. If your product is diagnosed as defective, obtain an RMA (return merchandise authorization) number from your dealer. This allows us to process your return more quickly.
4. Carefully pack the defective product, a fully-completed Repair and Replacement Order Card and a photocopy proof of purchase date (such as your sales receipt) in a shippable container. A product returned without proof of the purchase date is not eligible for warranty service.

5. Write the RMA number visibly on the outside of the package and ship it prepaid to your dealer.

Packing List

Before installing your board, ensure that the following materials have been received:

- 1 MIC-3358 all-in-one single board computer
- 1 Utility CD-ROM disc
- 1 CPU Heat sink (Assembled)
- 1 Thermal pad (Assembled)
- 1 RJ-45 to RS-232 COM port adaptor
- 1 Hard drive isolation pad (Assembled)
- 1 Hard drive bracket (Assembled)
- 1 Solder-side cover (Assembled)
- Several screws
- 1 warranty certificate document

If any of these items are missing or damaged, contact your distributor or sales representative immediately.

Warning!



Any changes or modifications made to the equipment which are not expressly approved by the relevant standards authority could void your authority to operate the equipment.

Caution!

Danger of explosion if battery is incorrectly installed. The battery should not be charged. Replace only with Advantech-specified batteries.

Contents

Chapter 1	Hardware Configuration	2
1.1	Introduction	2
1.2	Specifications	3
1.3	Functional Block Diagram	6
	Figure 1.1:MIC-3358 functional block diagram	6
1.4	Jumpers.....	6
1.4.1	Jumper Locations.....	6
	Table 1.1:MIC-3358 jumper descriptions.....	6
	Table 1.2:JP1 jumper definition.....	7
	Table 1.3:JP2 jumper definitions	7
	Table 1.4:JP7 jumper definitions	7
1.4.2	Clear CMOS (JP4).....	7
	Table 1.5:Clear CMOS JP4	8
1.5	Connectors.....	8
	Table 1.6:MIC-3358 connector descriptions	8
	Table 1.7:CN1 IDE Connector Definitions	9
	Table 1.8:CN2 CompactFlash™ Socket Definitions....	10
	Table 1.9:CN3 RJ-45 COM1 port Definitions.....	11
	Table 1.10:CN4 Handle Switch Definitions	12
	Figure 1.2:Handle Switch Definitions	12
	Table 1.11:CN5 USB 1.1/2.0 port Definitions	13
	Table 1.12:CN6 USB 1.1/2.0 port Definitions	13
	Table 1.13:CN9 DB-15 VGA Connector Definitions ..	14
	Table 1.14:PU1 Gigabit LAN Connector Definitions ..	14
	Table 1.15:J11/J12/J14 PMC Connector Definitions ..	15
	Table 1.16:D9 LED Definitions.....	18
	Table 1.17:SW1 Vcore selection definitions	18
	Table 1.18:SW2 Drone mode definitions	20
	Figure 1.3:MIC-3358 jumpers and connectors.....	21
	Figure 1.4:MIC-3358 front panel connectors	22
1.6	Safety Precautions	22
1.7	Installing CPU and Heat Sink	23
	Figure 1.5:Complete assembly	24
1.8	Software support	24
Chapter 2	Connecting Peripherals	26
2.1	IDE Device (CN1 and Rear I/O).....	26
2.2	VGA Display Connector (CN9 or Rear I/O).....	26
2.3	PS/2 Keyboard and Mouse Connector (Rear I/O).....	26
2.4	Serial Ports (CN3 and Rear I/O)	27
	Table 2.1:MIC-3358 serial port default settings.....	27

2.5	Ethernet Configuration (PU1 , Rear I/O and J3).....	27
2.6	USB Connector (CN5/6 and Rear I/O)	28
2.7	PMC Connector (J11, J12, J14)	28
2.8	CompactFlash™ Socket (CN2).....	28
2.9	Card Installation	28
Chapter 3	Driver Setup.....	32
3.1	Overview	32
3.2	USB driver.....	32
3.3	CMM (Chassis Management Module) Driver	33
3.3.1	Windows 2K Driver.....	33
	Figure 3.1:Select: My Computer --> Properties	33
	Figure 3.2:Select: Hardware --> Hardware Wizard.....	33
	Figure 3.3:Select: Next	34
	Figure 3.4:Select: Add/Troubleshoot a device	34
	Figure 3.5:Select: Add a new device	35
	Figure 3.6:Select: No	35
	Figure 3.7:Select: Other devices.....	36
	Figure 3.8:Click: Have Disk	36
	Figure 3.9:Browse for driver on CD-ROM	37
	Figure 3.10:Click: OK	37
	Figure 3.11:Click: OK	38
	Figure 3.12:Click: Yes.....	38
	Figure 3.13:Click: Next	39
	Figure 3.14:Click: Finish.....	39
	Figure 3.15:Click: Yes.....	40
	Figure 3.16:In Device Manager, select A-IPM Drivers.....	40
3.3.2	Windows XP Driver.....	41
	Figure 3.17:My Computer --> Properties".....	41
	Figure 3.18:Hardware --> Add Hardware Wizard.....	41
	Figure 3.19:Click: Next	42
	Figure 3.20:Click: Yes	42
	Figure 3.21:Select: Add a new hardware device	43
	Figure 3.22:Click: Install the hardware.....	43
	Figure 3.23:Select: Show all devices.....	44
	Figure 3.24:Select: Have Disk	44
	Figure 3.25:Select driver on CD-ROM.....	45
	Figure 3.26:Select A-IPM driver and click: Have Disk.....	45
	Figure 3.27:Click: Next	46
	Figure 3.28:Click: Finish.....	46
	Figure 3.29:My computer: A-IPM drivers.....	47
Chapter 4	Award BIOS Setup.....	50
4.1	AWARD BIOS Setup.....	50
	Figure 4.1:Setup program initial screen.....	50
4.1.1	Entering Setup.....	50

4.1.2	Standard CMOS Setup.....	51
	Figure 4.2:Standard CMOS setup screen.....	51
4.1.3	Advance BIOS Features Setup	51
	Figure 4.3:Advance BIOS features setup screen	52
4.1.4	Advance Chipset Features Setup	55
	Figure 4.4:Advance Chipset features setup screen	55
4.1.5	Integrated Peripherals	57
	Figure 4.5:Integrated Peripherals setup screen	57
4.1.6	Power Management Setup	60
	Figure 4.6:Power management setup screen.....	60
4.1.7	PNP/PCI Configuration Setup	61
	Figure 4.7:PNP/PCI configuration screen	61
4.1.8	PC Health Status	62
	Figure 4.8:PC Health setup screen.....	62
4.1.9	Load Optimized Defaults.....	62
4.1.10	Set Password.....	63
4.1.11	Save & Exit Setup.....	63
4.1.12	Exit Without Saving.....	63
Appendix A	Watchdog Timer.....	66
A.1	Programming the Watchdog Timer.....	66
Appendix B	Pin Assignments	70
B.1	J1 Connector.....	70
	Table B.1:J1 connector	70
B.2	J2 Connector.....	71
	Table B.2:J2 connector	71
B.3	J3 Connector.....	72
	Table B.3:J3 connector	72
B.4	J5 Connector.....	73
	Table B.4:J5 connector	73
B.5	System I/O Ports.....	74
	Table B.5:System I/O ports	74
B.6	Interrupt Assignments	75
	Table B.6:Interrupt assignments.....	75
B.7	1st MB Memory Map.....	75
	Table B.7:1st MB memory map	75

Hardware

Configuration

Chapter 1 Hardware Configuration

1.1 Introduction

The MIC-3358 is a CompactPCI® server blade with Intel® Pentium® 4 Processor-M on board to compliant with Compact Packet Switching Backplane (cPSB) systems. Supporting the PICMG 2.16 specification, the MIC-3358 delivers a cost performance platform for those applications that demand high performance. It is an ideal platform for emerging application such as switch-fabric blade server, mission critical and computing intensive applications.

The new MIC-3358 has been optimized for the Intel® Pentium® 4 Processor-M and Intel® 845E Chipset. It unveils as a high performance cPCI platforms, delivering compelling system bus speed performance across the 400 MHz with Intel NetBurst™ Micro-Architecture, Its innovated wider data paths and flexible memory refresh technology optimize the DDR SDRAM performance in MIC-3358.

High Performance Intel® Pentium® 4 Processor -M

The MIC-3358 supports Intel® Pentium® 4 processor-M 1.7GHz and 2.2GHz , with u-FCPGA package. The Intel® Pentium®4 processor-M has on-chip 512KB L2 cache providing high performance. With the support of a 400MHz front side bus, the MIC-3358 can fulfill customer's expectations of price-performance computing capability.

Compact Mechanical Design

The MIC-3358 has many functions on a single board with only one-slot width. Advantech provides a CPU heat sink specially designed for the Intel® Pentium®4 processor -M, enabling the MIC-3358 to operate without a cooling fan on the heat sink. It only needs external cooling air from the chassis fans for ventilation. This enables the MIC-3358 to use Intel® Pentium®4 processor - M within a mere 1-slot wide space.

Single P2P Bridge

The MIC-3358 with single PCI-to-PCI Bridge is applicable up to 8-slot enclosure and drive up to seven bus master PCI slots in master mode. Furthermore, it supports master and drone modes. The MIC-3358 can also operate in drone mode in a peripheral slot, whereby it functions as a stand-alone computer and does not communicate on the CompactPCI® bus.

PMC (PCI Mezzanine Card) IEEE1386.1 Compliant

The MIC-3358 support one PMC site and compliant with PICMG 2.3 (PCI Mezzanine Card) specification. This 32-bit/33MHz PMC interface provides front access capability by PMC modules for various function demanding.

Complete I/O Functions

The MIC-3358 offers all the I/O functions of an industrial computer with the rugged Eurocard form factor. The rest of I/O have fully connected to the rear I/O module via user-define connector (J3 and J5) on the back-plane. These I/O contain one Gigabit Ethernet port, one RJ-45 COM port, two USB 2.0 ports, one VGA connector, and one PMC site. The front panel also has a reset button and LEDs for hot swap indication, power status, HDD operation and Ethernet communication. The built-in high speed IDE controller provides two separate IDE channels with Ultra DMA/33/66/100 mode. The user-defined J3 connector is designed to support two IDE devices, one floppy drives, one printer device, LAN 1/2 for PCIMG 2.16. These drives can simply be connected to the backplane or to the rear transition board for easy service and maintenance.

Meets Switch Fabric, Mission Critical and Computing Intensive Application requirements

Supporting the PICMG 2.16 specification, the MIC-3358 delivers a cost performance platform for those applications that demand for low power and high performance. It is an ideal platform for emerging application such as switch-fabric blade server, mission critical and computing intensive applications like third-generation (3G) wireless, voice over Internet protocol (VoIP), networking, image processing and the converged data and voice communication applications.

The two-layer front panel design complies with IEEE 1101.10. Connectors are firmly screwed to the front panel, and the replaceable shielding gasket is attached to the panel edge. This reduces emissions and gives better protection against external interference. A watchdog timer can automatically reset the system if the system stops abnormally.

1.2 Specifications

Standard SBC Functions

- **CPU:** Intel® Pentium® 4 processor-M u-FCPGA socket
- **BIOS:** Award 4Mb flash memory

- **Chipset:** Intel® 845E/ICH4 Chipset
- **Front Side Bus:** 400MHz (Intel® Pentium® 4 processor-M Processor)
- **Bus Interface:** PCI 32-bit/33 MHz
- **2nd level cache:** Built-in 512KB on Intel® Pentium® 4 processor-M die
- **RAM:** 512MB ECC DDR266 memory on board. Support up to 2GB ECC DDR200/266.
- **Enhanced IDE interface:** Two channels handles one 2.5” IDE in SBC and two IDEs in RIO module via J3 connector. Supports PIO mode 4 and ATA 33/66/100 mode. One IDE connector and space reserved for embedded 2.5” HDD.
- **Serial ports:** One RJ-45 COM1 port (RS-232 interface) with 16C550 compatible UARTs
- **USB port:** Two USB ports with fuse protection comply with USB specification 2.0/1.1
- **CompactFlash socket:** one CompactFlash socket on board.
- **PMC expansion slot:** One 32bit/33MHz PCI Mezzanine site on board with +5V/+3.3V compliant.
- **Watchdog timer:** It provides system reset, interrupt and NMI support via software control. Time interval is from 1 to 255 seconds.

PCI-to-PCI Bridge

- **Controller chip:** One PCI-to-PCI bridge controller chip provides master and drone mode
- (Master mode) Supports up to seven bus masters peripherals on each bus segment
- (Drone mode) it could plug into a peripheral slot as a “drone mode” , whereby it functions as stand-alone computer.

10/100/1000Base-TX Ethernet Interface

- **Controller chips:** Two Intel® 82540EM Gigabit Ethernet controller chips provides Dual Gigabit ports
- One front RJ-45 Gigabit LAN port
- 10 Mbps, 100 Mbps and 1000Mbps auto-switching

PCI VGA Interface

- **Controller:** ATI Rage XL
- PCI 2.2 compliant, 32bit/33 MHz

- **Display memory:** 8MB SDRAM VRAM
- **Display Resolution Number of Colors:**

:

2D Display Modes: Resolutions, Colors and Maximum Refresh Rates (Hz)						
Resolution	640x 480	800x 600	1024x 768	1152x 864	1280x 1024	1600x 1200
256 colors	200	200	150	120	100	85
65K colors	200	200	150	120	100	85
16.7M colors	200	200	150	120	100	75

Maximum 3D Resolution(Hz)	
	8MB
65K colors	1600x1200
16.7M colors	1280x1024

Optional Rear I/O Boards

- **RIO-3309**

NOTE: MIC-3358 does not support MIC-3960 storage carrier board

Mechanical and Environmental Specifications

- **Operating temperature:** 0 ~ 55° C (32 ~ 131° F)
- **Storage Temperature:** -20 ~ 80° C (-4 ~ 176° F)
- **Humidity (Non-operating):** 5~95%@60° C (non-condensing)
- **Max Power Consumption:** +5V / 4.19A, +3.3V / 4.5A, +12V / 35mA
- **Board size:** 233.35 x 160 mm (6U size), 1-slot (4 TE) wide
- **Weight:** 0.8 kg (1.76 lb)
- **Shock:** 20 G (operating); 50 G (Non-operating)
- **Random vibration:** 1.5 Grms (operating), 2.0 Grms (Non-Operating)

Table 1.2: JP1 jumper definition



Table 1.3: JP2 jumper definitions



Table 1.4: JP7 jumper definitions



1.4.2 Clear CMOS (JP4)

This jumper is used to erase CMOS data and reset system BIOS information. Follow the procedures below to clear the CMOS.

1. Turn off the system.
2. Close jumper JP4 (1-2) for about 3 seconds.
3. Set jumper JP4 (2-3) as normal.
4. Turn on the system. The BIOS is reset to its default setting.

Table 1.5: Clear CMOS JP4

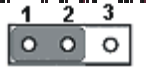
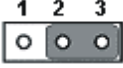
Clear	
Normal (default)	

1.5 Connectors

On-board connectors link to external devices such as hard disk drives, keyboards, or floppy drives, etc. Table 1-6 lists the function of each connector and Figure 1-1 and Figure 1-2 illustrate each connector location. Chapter 2 gives instructions for connecting external devices to your card.

Table 1.6: MIC-3358 connector descriptions

Number	Function
CN1	2.5" IDE Connector
CN2	CompactFlash™ Socket
CN3	RJ-45 COM1 port
CN4	Handle Switch
CN5	USB 1.1/2.0 port
CN6	USB 1.1/2.0 port
CN8	Reset Switch
CN9	DB-15 VGA Connector
PU1	Gigabit RJ-45 LAN Connector
J11/J12/J14	PMC Connector
J1/J2	Primary CompactPCI™ bus
J3/J5	Rear I/O transition
D9	HDD LED and Power LED
LED1	Hot Swap LED
SW1	Vcore selection
SW2	Drone mode Selection

Table 1.7: CN1 IDE Connector Definitions

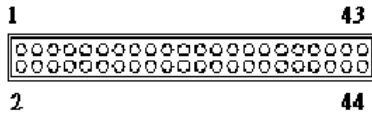

Pin	Signal	Pin	Signal
1	PRST#	2	GND
3	PID7	4	PID8
5	PID6	6	PID9
7	PID5	8	PID10
9	PID4	10	PID11
11	PID3	12	PID12
13	PID2	14	PID13
15	PID1	16	PID14
17	PID0	18	PID15
19	GND	20	N/C
21	PDRQ#	22	GND
23	PIOW#	24	GND
25	PIOR#	26	GND
27	PRDY	28	CSEL*
29	PACK#	30	GND
31	PIRQ	32	N/C
33	PDA1	34	PDIAG#**
35	PDA0	36	PDA2
37	PCS1#	38	PCS3#
39	HDD_LED	40	N/C
41	+5V	42	+5V
43	GND	44	N/C

#: active low

*: CSEL connected to GND

** : PDIAG# has 10K ohm pull-down to GND

Table 1.8: CN2 CompactFlash™ Socket Definitions

Pin	Signal	Pin	Signal
1	GND	26	N/C
2	ID3	27	ID11
3	ID4	28	ID12
4	ID5	29	ID13
5	ID6	30	ID14
6	ID7	31	ID15
7	HCS1-	32	HCS3-
8	GND	33	N/C
9	GND	34	HIOR-
10	GND	35	HIOW-
11	GND	36	N/C
12	GND	37	HIRQ
13	+5V	38	+5V
14	GND	39	SANDISK
15	GND	40	N/C
16	GND	41	-HRST1
17	GND	42	HRDY
18	GDA2	43	N/C
19	HDA1	44	N/C
20	HDA0	45	SANLED
21	ID0	46	N/C
22	ID1	47	ID8
23	ID2	48	ID9
24	N/C	49	ID10
25	N/C	50	GND

Table 1.9: CN3 RJ-45 COM1 port Definitions

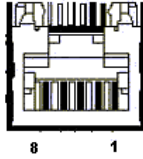

Pin	Signal
1	NRLSD1
2	NRX1
3	NTX1
4	NDTR1
5	GND
6	NDSR1
7	NRTS1
8	NCTS1

Table 1.10: CN4 Handle Switch Definitions

Pin	Signal
1	common
2	normal closed
3	normal open

*Note: Pin 1-2 handle closed
Pin 1-3 handle open*

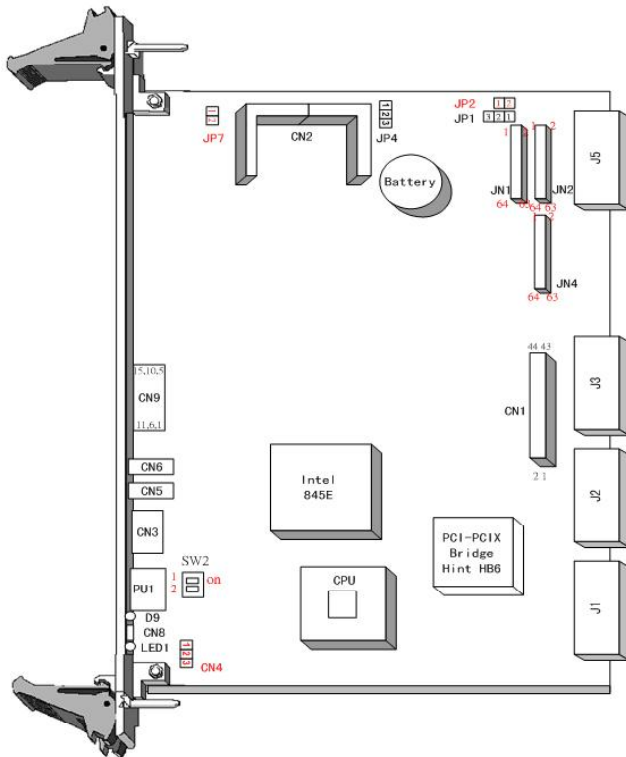

Note: Handle closed is normal

Figure 1.2: Handle Switch Definitions

Table 1.11: CN5 USB 1.1/2.0 port Definitions

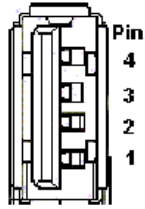

Pin	Signal
1	+5V
2	USB_P2-
3	USB_P2+
4	GND

Table 1.12: CN6 USB 1.1/2.0 port Definitions

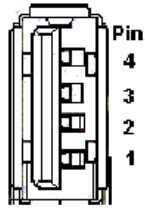

Pin	Signal
1	+5V
2	USB_P2-
3	USB_P2+
4	GND

Table 1.13: CN9 DB-15 VGA Connector Definitions

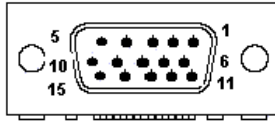

Pin	Signal
1	RED
2	GREEN
3	BLUE
4	N/C
5	GND
6	GND
7	GND
8	GND
9	N/C (VGA_VCC)
10	GND
11	N/C
12	VGA_SDA
13	HSYNC
14	VSYNC
15	VGA_SCL

Table 1.14: PU1 Gigabit LAN Connector Definitions

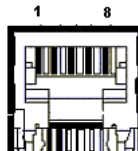

Pin	Signal
1	MDIAX1+
2	MDIAX1-

3	MDIAX2+
4	MDIAX3+
5	MDIAX3-
6	MDIAX2-
7	MDIAX4+
8	MDIAX4-

The LED indicator means

Left		Right
10Mbps	Off	flick active/link mode
100Mbps	Green	
1000Mbps	Orange	

Table 1.15: J11/J12/J14 PMC Connector Definitions

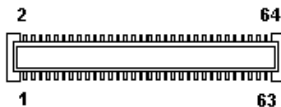

J11 PIN SIGNAL

PIN#	Single Name	PIN#	Single Name
1	TCK	2	-12V
3	GND	4	INTC#
5	INTD#	6	INTA#
7	BUSMODE1	8	+5V
9	INTB#	10	N/C
11	GND	12	N/C
13	CLK	14	GND
15	GND	16	GNT4#
17	REQ4#	18	+5V
19	V(I/O)	20	AD31
21	AD28	22	AD27
23	AD25	24	GND
25	GND	26	C/BE3#
27	AD22	28	AD21
29	AD19	30	+5V
31	V(I/O)	32	AD17

33	FRAME#	34	GND
35	GND	36	IRDY#
37	DEVSEL#	38	+5V
39	GND	40	LOCK#
41	SDONE#	42	SBO#
43	PAR	44	GND
45	V(I/O)	46	AD15
47	AD12	48	AD11
49	AD9	50	+5V
51	GND	52	C/BE0#
53	AD6	54	AD5
55	AD4	56	GND
57	V(I/O)	58	AD3
59	AD2	60	AD1
61	AD0	62	+5V
63	GND	64	REQ64#

J12 PIN SIGNAL

PIN#	Single Name	PIN#	Single Name
1	+12V	2	TRST#
3	TMS	4	TDO
5	TDI	6	GND
7	GND	8	N/C
9	N/C	10	N/C
11	BUSMODE2#	12	+3.3V
13	RST#	14	BUSMODE3#
15	+3.3V	16	BUSMODE4#
17	N/C	18	GND
19	AD30	20	AD29
21	GND	22	AD26
23	AD24	24	+3.3V
25	IDSEL(AD19)	26	AD23
27	+3.3V	28	AD20
29	AD18	30	GND
31	AD16	32	C/BE2#
33	GND	34	N/C
35	TRDY#	36	+3.3V
37	GND	38	STOP#
39	PERR#	40	GND

41	+3.3V	42	SERR#
43	C/BE1#	44	GND
45	AD14	46	AD13
47	GND	48	AD10
49	AD8	50	+3.3V
51	AD7	52	N/C
53	+3.3V	54	N/C
55	N/C	56	GND
57	N/C	58	N/C
59	GND	60	N/C
61	ACK64#	62	+3.3V
63	GND	64	N/C

J14 Pin Signal

PIN#	Single Name	PIN#	Single Name
1	+5Vaux	2	+5V
3	+5Vaux	4	+5V
5	GND	6	GND
7	N/C	8	N/C
9	N/C	10	N/C
11	N/C	12	N/C
13	N/C	14	N/C
15	N/C	16	N/C
17	N/C	18	N/C
19	N/C	20	N/C
21	N/C	22	N/C
23	N/C	24	N/C
25	N/C	26	N/C
27	BMC_PWR_ON/OFF	28	N/C
29	BMC_PWROK	30	PMC_OS_SHUTDOWN
31	GA1	32	GA0
33	GA3	34	GA2
35	N/C	36	GA4
37	N/C	38	BMC_BD_SEL#
39	N/C	40	N/C
41	N/C	42	N/C
43	N/C	44	N/C
45	N/C	46	N/C

47	CMM1_SCL	48	CMM1_SDA
49	CMM2_SCL	50	CMM2_SDA
51	BMC_BD_SEL	52	N/C
53	N/C	54	N/C
55	BMC_LEDA	56	BMC_LEDL
57	GND	58	GND
59	BMC_TX+	60	BMC_RX+
61	BMC_TX-	62	BMC_RX-
63	GND	64	GND

Table 1.16: D9 LED Definitions

Green	Power Status
Yellow	HDD Status

Table 1.17: SW1 Vcore selection definitions

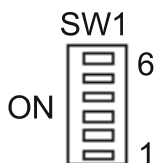

It's automatic selection when SW1-1~SW1-6 are all OFF.

SW1- 6	SW1- 5	SW1- 4	SW1- 3	SW1- 2	SW1- 1	VCORE
OFF	X	X	X	X	X	AUTO
ON	ON	ON	ON	ON	ON	1.750V
ON	ON	ON	ON	ON	OFF	1.700V
ON	ON	ON	ON	OFF	ON	1.650V
ON	ON	ON	ON	OFF	OFF	1.600V
ON	ON	ON	OFF	ON	ON	1.550V
ON	ON	ON	OFF	ON	OFF	1.500V
ON	ON	ON	OFF	OFF	ON	1.450V
ON	ON	ON	OFF	OFF	OFF	1.400V
ON	ON	OFF	ON	ON	ON	1.350V
ON	ON	OFF	ON	ON	OFF	1.300V
ON	ON	OFF	ON	OFF	ON	1.250V
ON	ON	OFF	ON	OFF	OFF	1.200V
ON	ON	OFF	OFF	ON	ON	1.150V
ON	ON	OFF	OFF	ON	OFF	1.100V
ON	ON	OFF	OFF	OFF	ON	1.050V
ON	ON	OFF	OFF	OFF	OFF	1.000V
ON	OFF	ON	ON	ON	ON	0.975V
ON	OFF	ON	ON	ON	OFF	0.950V
ON	OFF	ON	ON	OFF	ON	0.925V
ON	OFF	ON	ON	OFF	OFF	0.900V

PS: X means either ON or OFF.

Table 1.18: SW2 Drone mode definitions

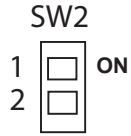

When SW2 is ON, then the board is selected as drone mode. The rest of the combination is reserved for other modes.

Please refer to Appendix B for J1/2/3/5 pin assignments.

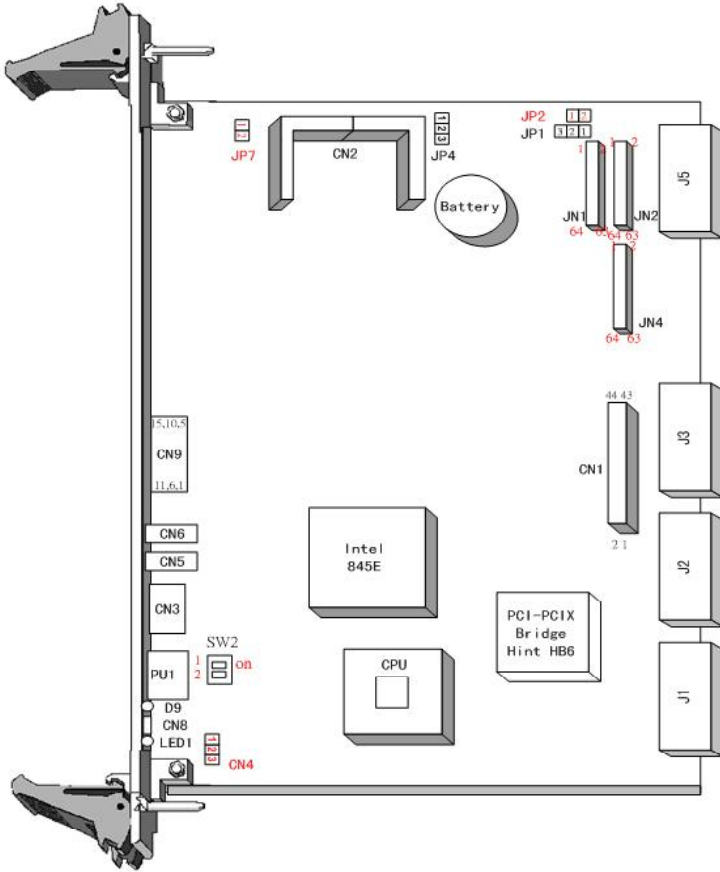

Figure 1.3: MIC-3358 jumpers and connectors

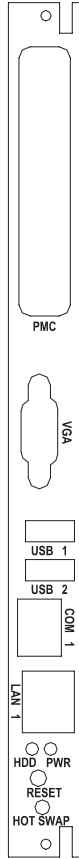

Figure 1.4: MIC-3358 front panel connectors

1.6 Safety Precautions

Follow these simple precautions to protect yourself from harm and the products from damage.

1. To avoid electric shock, always disconnect the power from your PC chassis before you work on it. Don't touch any components on the CPU card or other cards while the PC is on.

2. Disconnect power before making any configuration changes. The sudden rush of power as you connect a jumper or install a card may damage sensitive electronic components.
3. Always ground yourself to remove any static charge before you touch your CPU card. Be particularly careful not to touch the chip connectors. Modern integrated electronic devices, especially CPUs and memory chips, are extremely sensitive to static electric discharges and fields. Keep the card in its antistatic packaging when it is not installed in the PC, and place it on a static dissipative mat when you are working with it. Wear a grounding wrist strap for continuous protection.

1.7 Installing CPU and Heat Sink

The MIC-3358 supports Intel® Pentium® 4 processor - M . In order to meet critical environmental conditions and the physical space of the MIC-3358 at the same time, Advantech designed a heat sink to fulfill its primary needs. Please refer to Figure 1-4 for an illustration of the heat sink used for the MIC-3358.

The small aluminum plate is default fastened on the CPU in the factory.

When user doing the memory installation, the following steps should be followed:

1. Remove the screws for the solder side cover. At this step, the front panel will be also loose. Be careful about any improper disassemble procedure that could cause any damage of SBC.
2. Remove the rest four screws for heatsink standing, then the heat-sink is loose for memory installation and relevant.
3. Follow the opposed procedure to assembly the heatsink and solder side cover.

Note: *The heat pad is sealed between heatsink and CPU is kind of frangible, please be careful on the disassemble procedure. And be careful with any other damage of heat pad will cause the thermal issue easily.*

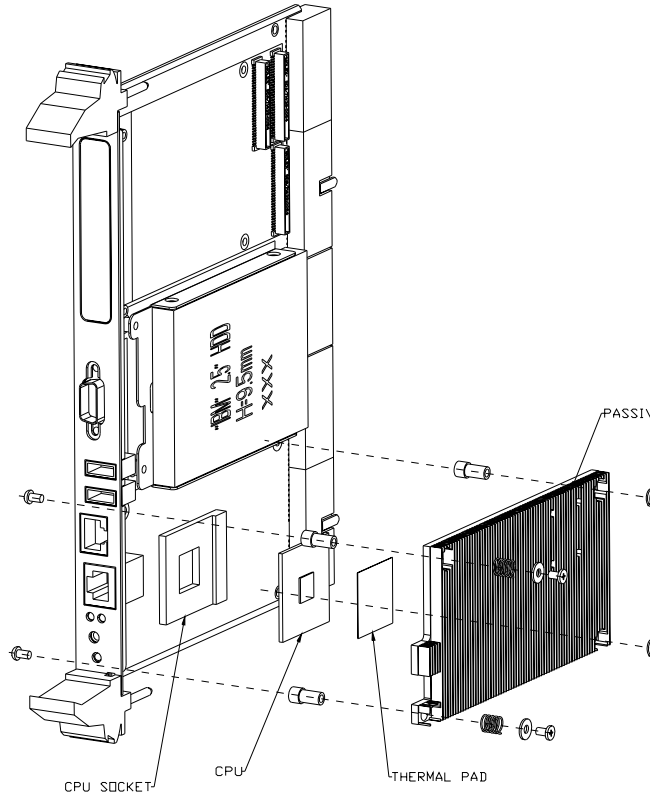

Figure 1.5: Complete assembly

1.8 Software support

The MIC-3358 comes with a utility CD-ROM disc, which includes drivers and utility programs of Gigabit Ethernet, IAA and VGA interfaces. The drivers support Windows 2000, XP and NT4.0 Operation systems. Please visit Intel® website for detailed explanation.

CHAPTER
2

**Connecting
Peripherals**

Chapter 2 Connecting Peripherals

2.1 IDE Device (CN1 and Rear I/O)

The MIC-3358 provides two IDE (Integrated Device Electronics) channels via CN1 connector in MIC-3358 or via the J3 connector to the rear transition board (RIO-3309C). CN1 connector support one 2.5" IDE HDD in MIC-3358 and two IDE drives can be connected to Secondary IDE connector (CN19) in the rear transition board. If two drives are installed on one channel, remember to set one as the master and the other one as the slave. You may do this by setting the jumpers on the drives. Refer to the documentation that came with your drive for more information. A jumper diagram usually appears on the topside of a hard disk drive.

Warning: Plug the other end of the cable into the drive with pin #1 on the cable corresponding to pin #1 on the drive. Improper connection will damage the drive.

2.2 VGA Display Connector (CN9 or Rear I/O)

The MIC-3358 provides a VGA chipset (ATI Rage XL) built-in display for high performance application. The CN9 connector of MIC-3358 and CN7 connector of rear I/O board are both DB-15 connector for VGA monitor input. The system monitor display is able to be selected by jumper JP2.

2.3 PS/2 Keyboard and Mouse Connector (Rear I/O)

The MIC-3358 provides Keyboard/Mouse support via J5 connector to the rear transition board which builds in one PS/2 Keyboard/Mouse connector (CN12). The package - one Y-type PS/2 keyboard/mouse cable - provides two transferred connectors. Since these two connectors are identical, please, follow the icons on the cable to plug the keyboard and the mouse into their correct connectors.

2.4 Serial Ports (CN3 and Rear I/O)

The MIC-3358 offers one serial ports: COM1 in RS-232. With limited front panel access, one COM1 (CN3) can be connected via a RJ-45 to RS-232 adaptor and COM2 (CN9) interface has to be connected via rear I/O module (RIO-3309C) for implement. These ports allow users to connect to serial devices (a mouse, printers, etc.) or a communication network. You can select the address for each port to disable it, using the BIOS Advanced Setup program, covered in Chapter 5. Different devices implement the RS-232 standard in different ways. If you are having problems with a serial device, be sure to check the pin assignments for the connector. The IRQ and address range for both ports are fixed. However, if you wish to disable the port or change these parameters later, you can do this in the system BIOS setup. The table below shows the settings for the MIC-3358 board's ports:

Table 2.1: MIC-3358 serial port default settings

Port	Address	Default
COM1	3F8, 3E8	IRQ4
COM2	2F8, 2E8	IRQ3

2.5 Ethernet Configuration (PU1 , Rear I/O and J3)

The MIC-3358 is equipped with dual high performance 32-bit PCI-bus Gigabit Ethernet interfaces which are fully compliant with IEEE 802.3u 10/100/1000Base-TX specifications. Users can select front GbE or rear GbE or 2.16 by BIOS. Users can choice LAN1 connector either via front RJ-45 jack (PU1) in MIC-3358 or rear RJ-45 (CN16) in rear module. Another one Gigabit LAN connector (CN15) has to go through RIO module (RIO-3309C).

Moreover, the MIC-3358 supports PICMG 2.16 complaint with Packet Switching Backplane Specification via J3 connector, it will installed in PICMG 2.16 backplane as switch-fabric applications blade server

2.6 USB Connector (CN5/6 and Rear I/O)

The MIC-3358 provides two USB (Universal Serial Bus) 2.0 channels either via two front USB ports (CN5 and CN6) in MIC-3358 or via J5 connector to one USB connector (CN8) in real transition board. The USB interface gives complete plug and play, hot attach/detach for up to 127 external devices. The MIC-3358 USB interface complies with USB specification rev. 2.0 and is polyswitch protected. The USB interface can be disabled in the system BIOS setup. The USB controller default is "Enabled" but the USB keyboard support default is "Disabled".

2.7 PMC Connector (J11, J12, J14)

The MIC-3358 supports one PMC (PMC Mezzanine Card) modules on PCI bus. This 32-bit, 3.3/5 V(I/O) PCI bus is available at connectors J11 and J12. J14 is applied for user definitions. Front panel access is provided for the PMC interface.

2.8 CompactFlash™ Socket (CN2)

CompactFlash™ is a standard form factor for mass storage and I/O cards. Based on the PCMCIA Standard, CompactFlash™ cards are approximately 1/4 the volume of a PC Card. In order to achieve the small size, the interface pin count is 50-pins compared to the PCMCIA's 68-pin.

The MIC-3358 supports one CompactFlash™ socket in CN2 connector. It helps file and data storage in the CompactFlash™ card rather than the traditional hard drive.

2.9 Card Installation

The CompactPCI™ connectors are firm and rigid, and require careful handling while plugging and unplugging. Improper installation of a card can easily damage the backplane of the chassis. The inject/eject handles

of MIC-3358 help you install and remove the card easily and safely. Follow the procedure below to install the

MIC-3358 into a chassis:

To install a card:

1. Hold the card vertically. Be sure that the card is pointing in the correct direction. The components of the card should be pointing to the right-hand side.
2. Pull out both handles to unlock it.

Caution: Keep your fingers away from the hinge to prevent your fingers from getting pinched.

3. Insert the card into the chassis by sliding the upper and lower edges of the card into the card guides.
4. Push the card into the slot gently by sliding the card along the card guide until the handles meet the rectangular holes of the cross rails. Note: If the card is correctly positioned and has been slid all the way into the chassis, the handle should match the rectangular holes. If not, remove the card from the card guide and repeat step 3 again. Do not try to install a card by forcing it into the chassis.
5. Pull the upper handle down and lift the lower handle up to push the card into place.
6. Secure the card by pushing in the red handle to lock it into place.

To remove a card:

1. Unscrew the screws on the front panel.
2. Lift the upper handle up and press the lower handle down to release the card from the backplane.
3. Slide the card out.

CHAPTER
3

Driver Setup

Chapter 3 Driver Setup

3.1 Overview

Advantech provides CD utility driver in the package. Please install Chipset INF driver, VGA graphics driver, LAN driver and Intel® Application Accelerator (IAA) driver sequentially.

The Intel® Application Accelerator is a performance software package of Intel® chipsets. It reduces the storage sub-system bottleneck, enabling faster delivery of data from the hard drive to the processor and other system level hardware. Meanwhile, it enables a performance-enhancing data pre-fetcher for Intel® Pentium® 4 and Pentium® M processor-based systems. In addition, it delivers faster overall system boot times by significantly accelerating the load time of the OS - enabling you to build Pentium® 4 and Pentium® M processor-based systems with a better overall end-user experience. IAA supports 48-bit Logical Block Addressing (48-bit LBA) for 137 GB and larger hard drives. Furthermore, IAA enables Automatic Selection of Highest DMA Transfer Mode by the ATA/ATAPI device/Intel chipset.

3.2 USB driver

If the manufacturer/vendor of a USB device recommends downloading an Intel® USB driver update as part of troubleshooting your USB device, please contact Microsoft® for USB driver support. Intel manufactures the host controller but the driver is from Microsoft. While users installed Intel INF driver, it will not install USB driver. Please go to "device manager" to update USB driver via Advantech CD utility or via Microsoft website.

Note: *There are no separate USB (version 1.1 and earlier) drivers available for download for Intel® chipsets.*

3.3 CMM (Chassis Management Module) Driver

MIC-3358 supports MIC-3924B CMM. Please install the driver according to the following procedure.

3.3.1 Windows 2K Driver

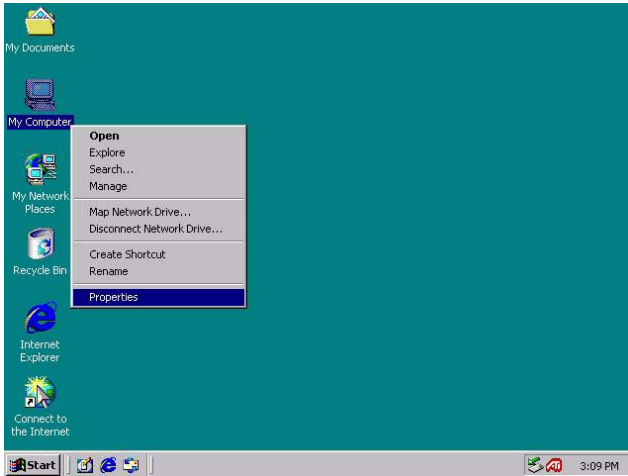

Figure 3.1: Select: My Computer --> Properties



Figure 3.2: Select: Hardware --> Hardware Wizard

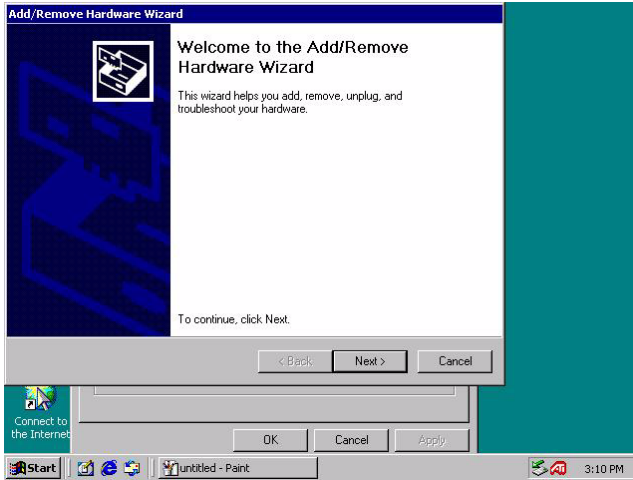

Figure 3.3: Select: Next

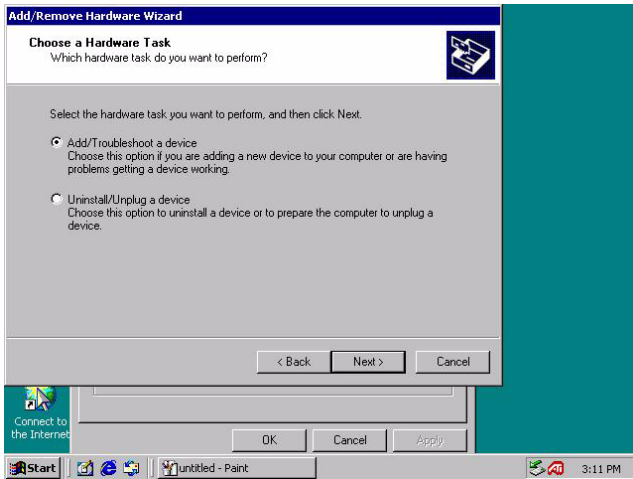

Figure 3.4: Select: Add/Troubleshoot a device

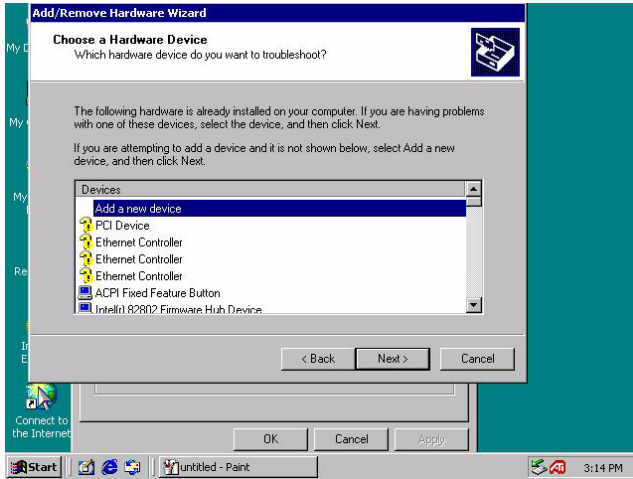

Figure 3.5: Select: Add a new device

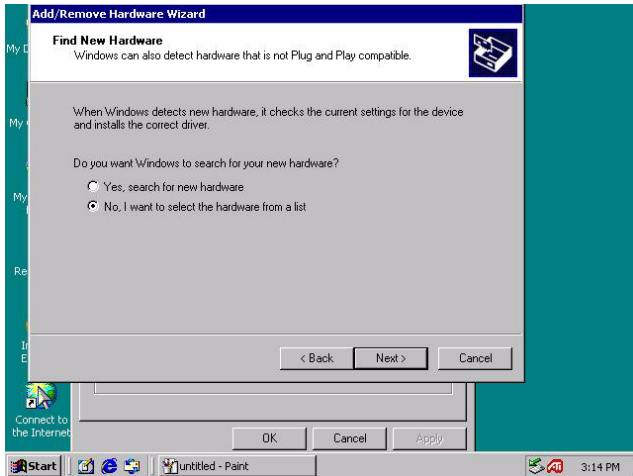

Figure 3.6: Select: No

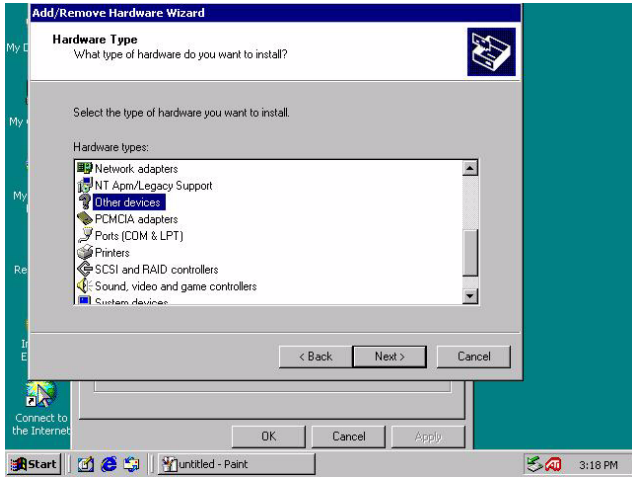

Figure 3.7: Select: Other devices

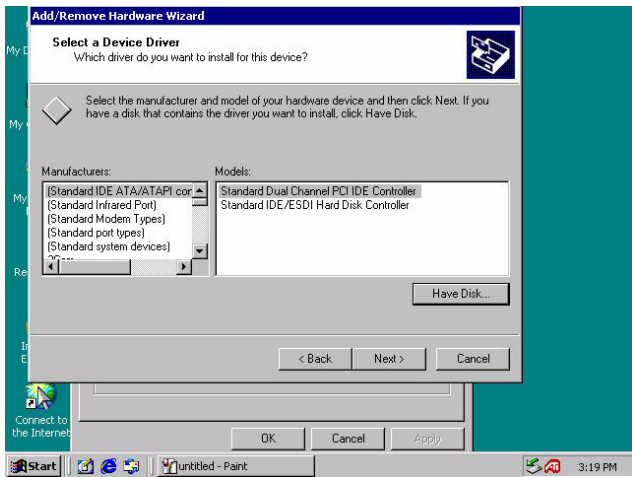

Figure 3.8: Click: Have Disk

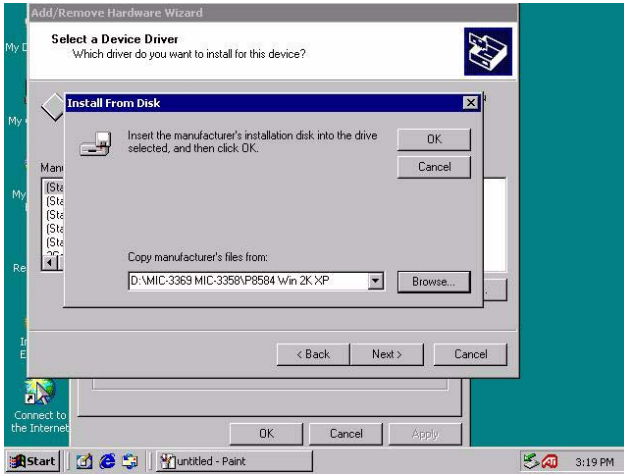

Figure 3.9: Browse for driver on CD-ROM

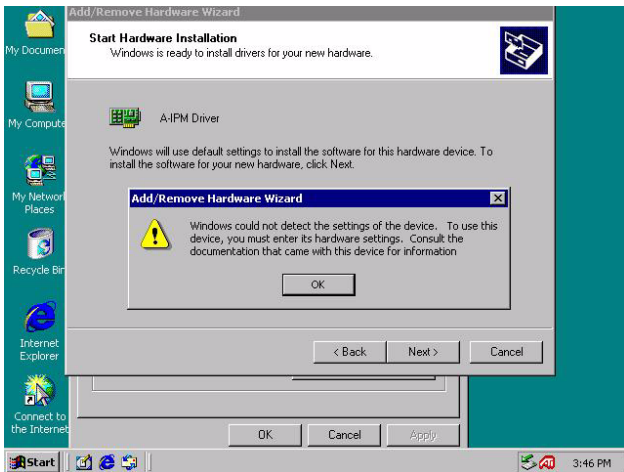

Figure 3.10: Click: OK

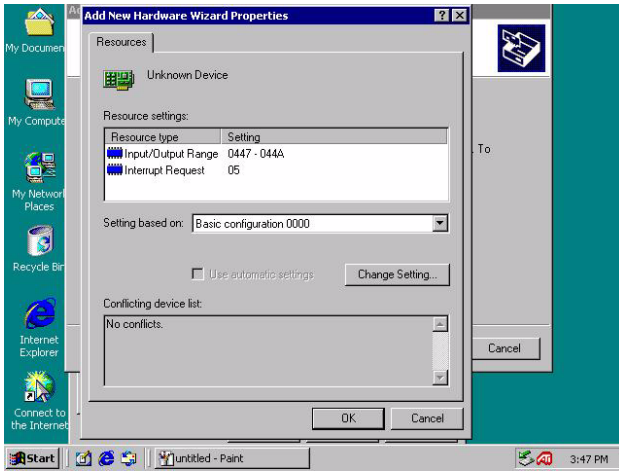

Figure 3.11: Click: OK

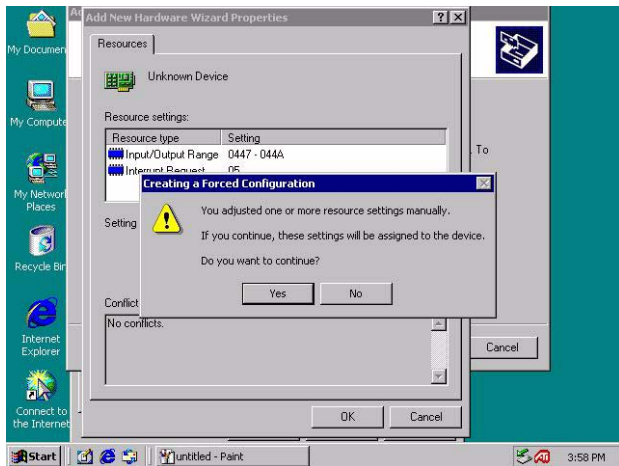

Figure 3.12: Click: Yes

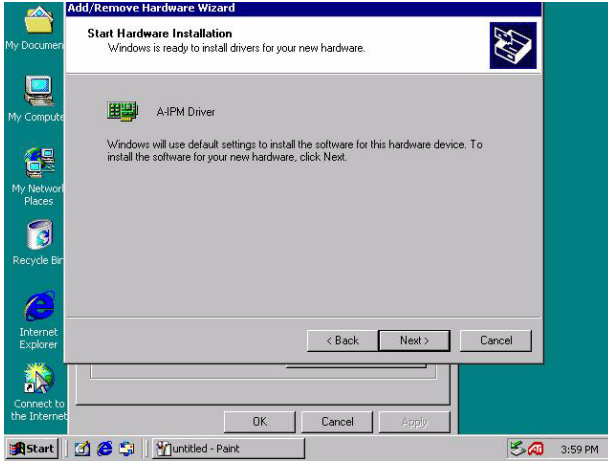

Figure 3.13: Click: Next

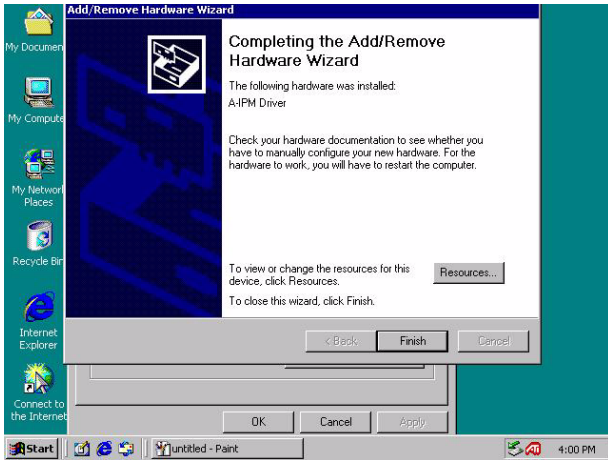

Figure 3.14: Click: Finish

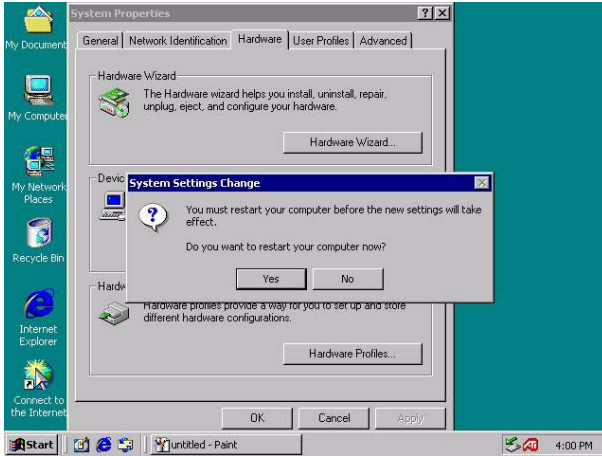

Figure 3.15: Click: Yes

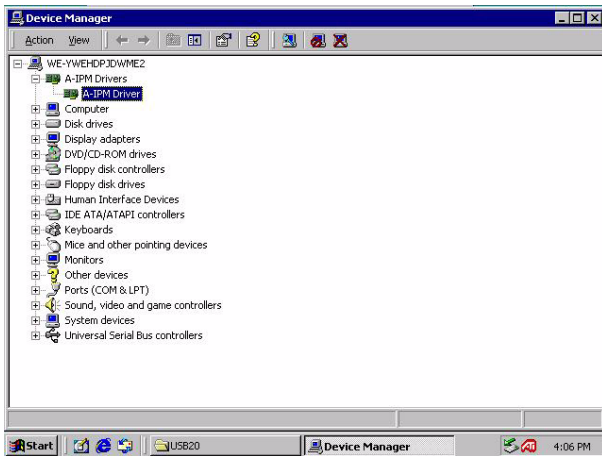

Figure 3.16: In Device Manager, select A-IPM Drivers

3.3.2 Windows XP Driver

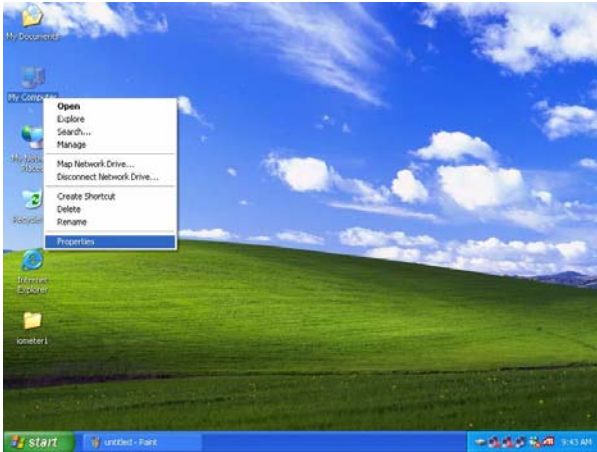

Figure 3.17: My Computer --> Properties"

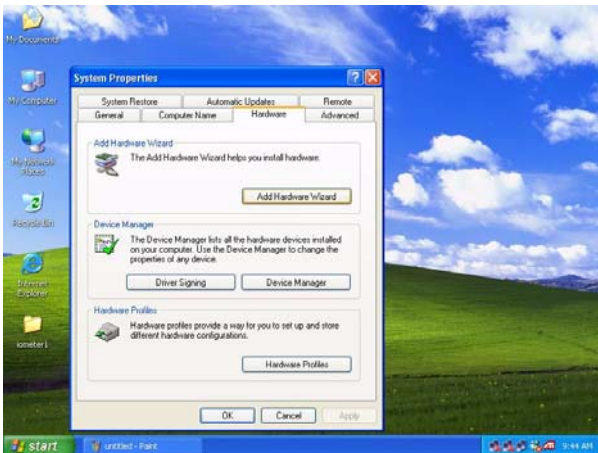

Figure 3.18: Hardware --> Add Hardware Wizard

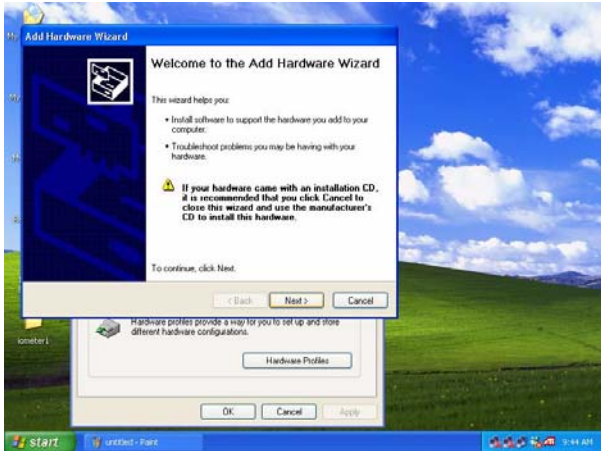

Figure 3.19: Click: Next

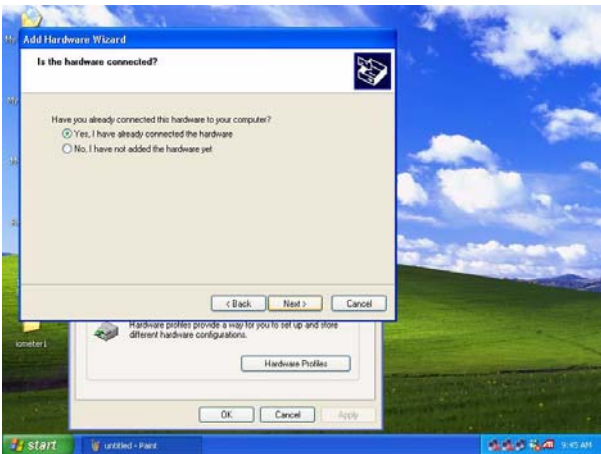

Figure 3.20: Click: Yes

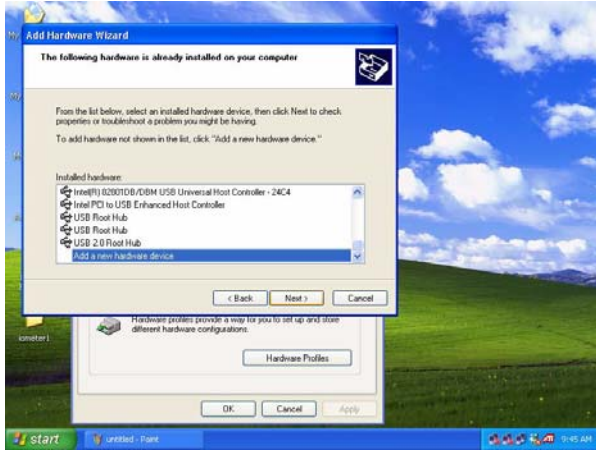

Figure 3.21: Select: Add a new hardware device

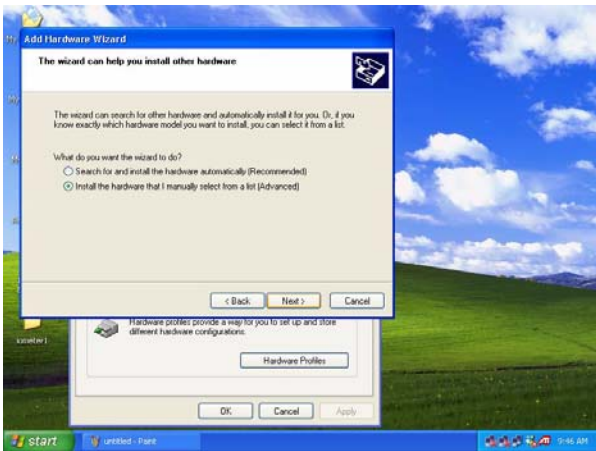

Figure 3.22: Click: Install the hardware...

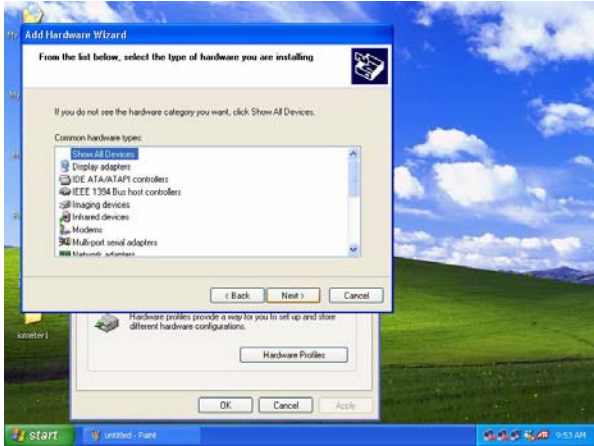

Figure 3.23: Select: Show all devices

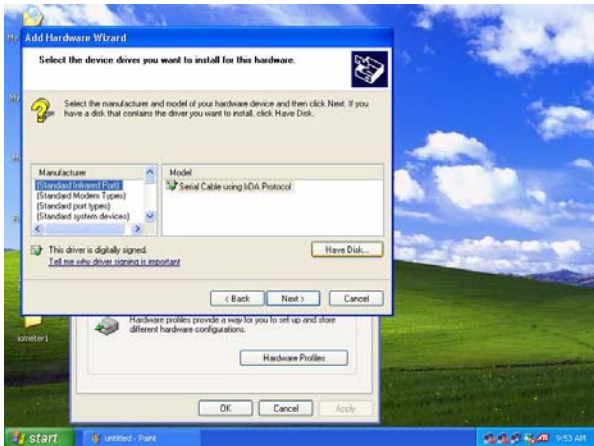

Figure 3.24: Select: Have Disk

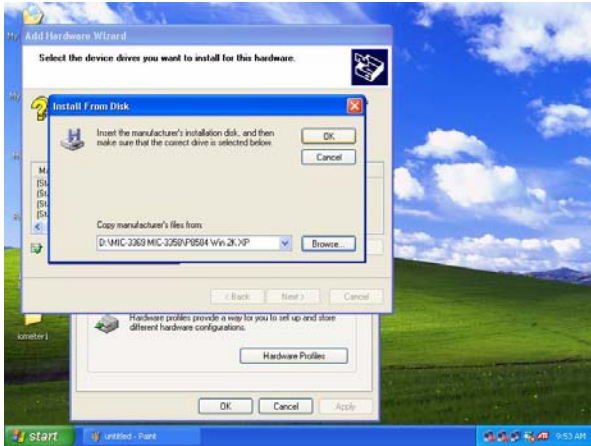

Figure 3.25: Select driver on CD-ROM

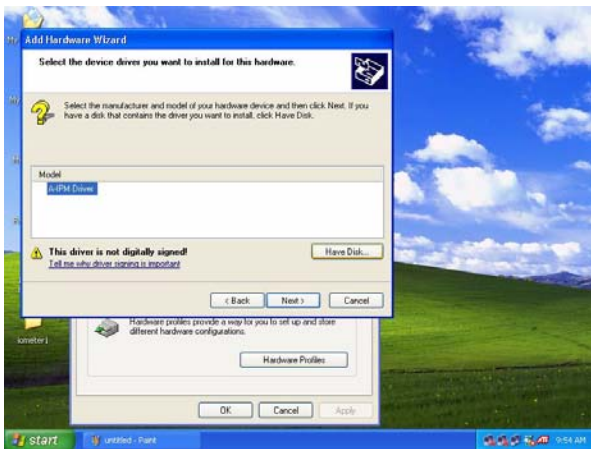

Figure 3.26: Select A-IPM driver and click: Have Disk

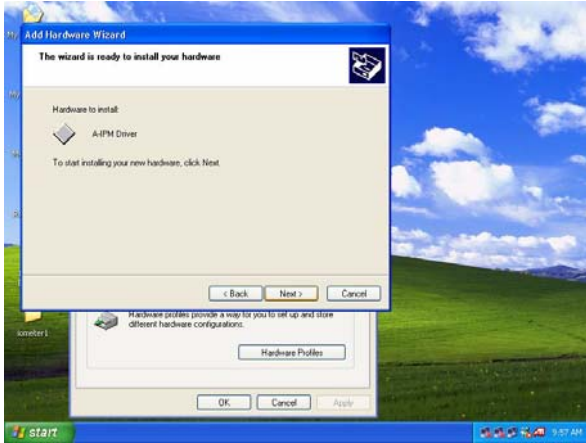

Figure 3.27: Click: Next



Figure 3.28: Click: Finish

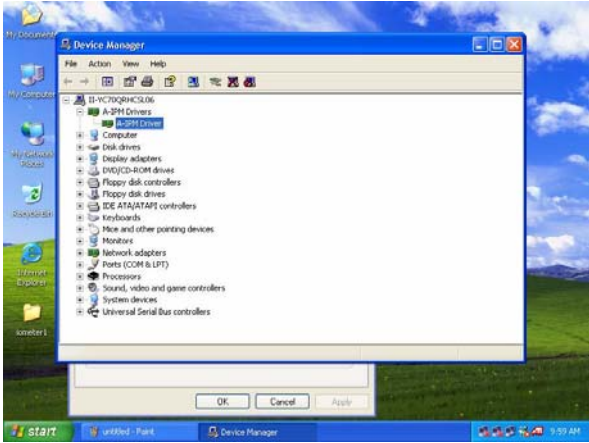

Figure 3.29: My computer: A-IPM drivers

CHAPTER **4**

Award BIOS Setup

Chapter 4 Award BIOS Setup

4.1 AWARD BIOS Setup

Once you enter Award® BIOS CMOS Setup Utility, the Main Menu (Figure 4-1) will appear on the screen. The Main Menu allows you to select from nine setup functions and two exit choices. Use arrow keys to select among the items and press <Enter> to accept or enter the sub-menu.

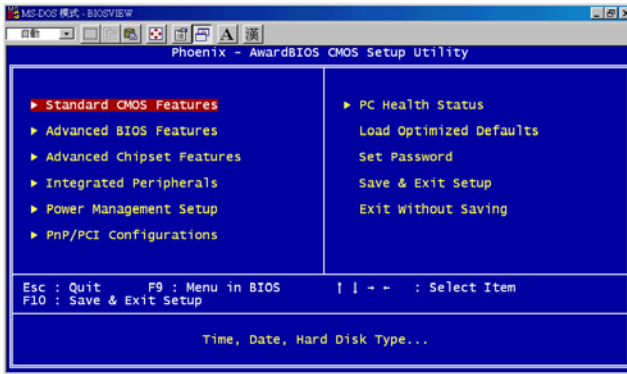

Figure 4.1: Setup program initial screen

Award's BIOS ROM has a built-in Setup program that allows users to modify the basic system configuration. This type of information is stored in battery-backed CMOS so that it retains the Setup information when the power is turned off.

4.1.1 Entering Setup

Turn on the computer and check for the "patch code". If there is a number assigned to the patch code, it means that the BIOS support your CPU. If there is no number assigned to the patch code, please contact Advantech's application engineer to obtain an up-to-date patch code file. This will ensure that your CPU's system status is valid. After ensuring that you have a number assigned to the patch code, press and you will immediately be allowed to enter Setup.

4.1.2 Standard CMOS Setup

The items in Standard CMOS Setup Menu are divided into 11 categories. Each category includes no, one or more than one setup items. Use the arrow keys to highlight the item and then use the <PgUp> or <PgDn> keys to select the value you want in each item.

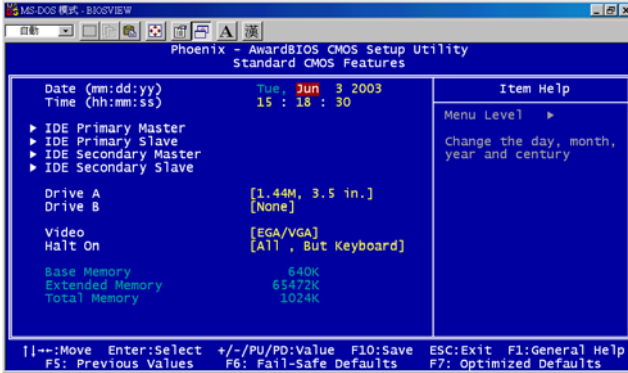

Figure 4.2: Standard CMOS setup screen.

Primary Master/Primary Slave/Secondary Master/Secondary Slave

Press PgUp/<+> or PgDn/<-> to select Manual, None, Auto type. Note that the specifications of your drive must match with the drive table. The hard disk will not work properly if you enter improper information for this category. If your hard disk drive type is not matched or listed, you can use Manual to define your own drive type manually. If you select Manual, related information is asked to be entered to the following items. Enter the information directly from the keyboard. This information should be provided in the documentation from your hard disk vendor or the system manufacturer.

4.1.3 Advance BIOS Features Setup

The "Advance BIOS FEATURES" screen will appear after the BIOS FEATURES SETUP item from the CMOS SETUP UTILITY Menu was chosen. This screen allows the user to configure the board according to his particular requirements. Below are some major items that are provided in the BIOS FEATURES SETUP screen:

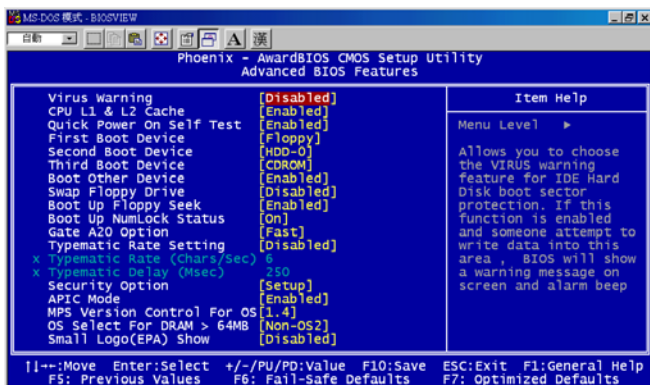

Figure 4.3: Advance BIOS features setup screen

Virus Warning

During and after the system boots up, any attempt to write to the boot sector or partition table of the hard disk drive will halt the system. If this happens, a warning message will be displayed. You can run the anti-virus program to locate the problem. If Virus Warning is disabled, no warning message will appear if anything attempts to access the boot sector or hard disk partition.

CPU L1 & L2 Cache

The default value is Enabled.

Enabled (default)	Enable cache
-------------------	--------------

Disabled	Disable cache
----------	---------------

Note: The internal cache is built in the processor.

Quick Power On Self Test

This category speeds up Power On Self Test (POST) after you power on the computer. If this is set to Enabled, BIOS will shorten or skip some check items during POST.

Enabled (default)	Enable quick POST
-------------------	-------------------

Disabled	Normal POST
----------	-------------

First/Second/Third Boot Device and Boot Other Device

The BIOS attempts to load the operating system from the devices in the sequence selected in these items. The settings are Floppy, LS120, HDD-0, SCSI, CDROM, HDD-1, HDD-2, HDD-3, ZIP100, USB-FDD, USB-ZIP, USB-CDROM, USB-HDD, LAN and Disabled.

	Default
First boot device	Floppy
Second boot device	HDD-0
Third boot device	CD-ROM

PS: When you boot by USB CD-ROM, please install Win XP with SP1 or Win 2000 with SP3.

Swap Floppy Drive

Switches the floppy disk drives between being designated as A and B. Default is Disabled.

Boot Up Floppy Seek

During POST, BIOS will determine if the floppy disk drive installed is 40 or 80 tracks. 360K type is 40 tracks while 760K, 1.2M and 1.44M are all 80 tracks. Default is Enabled.

Boot Up NumLock Status

The default value is On.

On (default)	Keypad is numeric keys.
Off	Keypad is arrow keys.

Gate A20 Option

Normal	The A20 signal is controlled by keyboard controller or chipset hardware.
Fast(default)	The A20 signal is controlled by port 92 or chipset specific method.

Typematic Rate Setting

Key strokes repeat at a rate determined by the keyboard controller. When enabled, the typematic rate and typematic delay can be selected. The settings are: Enabled/Disabled. Default is Disabled.

Typematic Rate (Chars/Sec)

Set the number of times a second to repeat a key stroke when you hold the key down. The settings are: 6, 8, 10, 12, 15, 20, 24, 30.

Typematic Delay (Msec)

Sets the delay time after the key is held down before it begins to repeat the keystroke. The settings are: 250, 500, 750, 1000.

Security Option

This category allows you to limit access to the system and Setup, or just to Setup.

System	The system will not boot and access to Setup will be denied if the correct password is not entered at the prompt.
Setup(default)	The system will boot, but access to Setup will be denied if the correct password is not entered at the prompt.

APIC Mode (Advanced Programmable Interrupt Controller)

Default is Enabled.

MPS Version Control for OS

The options includes 1.1 and 1.4. Default is 1.4

OS Select For DRAM > 64MB

Allows OS2® to be used with > 64 MB of DRAM. Settings are Non-OS/2 (default) and OS2. Set to OS/2 if using more than 64MB and running OS/2®.

Small logo (EPA) show

Default is Disabled.

4.1.4 Advance Chipset Features Setup

The Advanced Chipset Features Setup option is used to change the values of the chipset registers. These registers control most of the system options in the computer. Choose the "ADVANCED CHIPSET FEATURES" from the Main Menu and the following screen will appear.

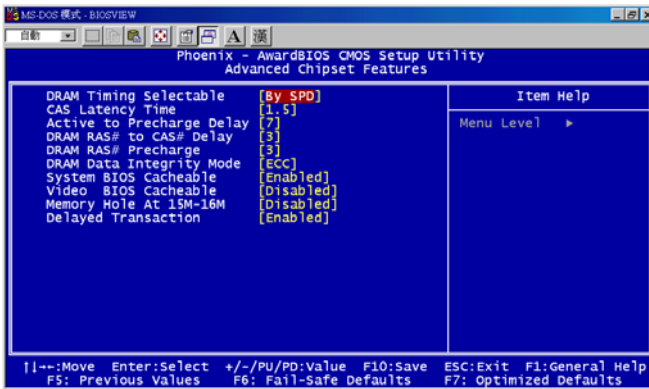

Figure 4.4: Advance Chipset features setup screen

DRAM Timing Configure

This field lets you select system memory timing data. Manual and BY SPD are two options. Default is "BY SPD"

CAS Latency Time

When synchronous DRAM is installed, the number of clock cycles of CAS latency depends on the DRAM timing. The settings are: 1.5, 2 and 2.5.

Active to Precharge Delay

This field let you select active to precharge delay. The settings are: 7, 6 and 5

DRAM RAS# to CAS# Delay

This field lets you insert a timing delay between the CAS and RAS strobe signals, used when DRAM is written to, read from, or refreshed. Fast gives faster performance; and Slow gives more stable performance. This field applies only when synchronous DRAM is installed in the system. The settings are: 2 and 3.

DRAM RAS# Precharge

If an insufficient number of cycles is allowed for the RAS to accumulate its charge before DRAM refresh, the refresh may be incomplete and the DRAM may fail to retain data. Fast gives faster performance; and Slow gives more stable performance. This field applies only when synchronous DRAM is installed in the system. The settings are: 2 and 3.

DRAM Data Integrity Mode

The settings are ECC (Default) and non-ECC.

Memory Frequency For

User can select 3 options: DDR200, DDR266, Auto (Default)

System BIOS Cacheable

Selecting Enabled allows caching of the system BIOS ROM at F0000h-FFFFFh, resulting in better system performance. However, if any program writes to this memory area, a system error may result. The settings are: Enabled (Default) and Disabled.

Video BIOS Cacheable

Select Enabled allows caching of the video BIOS, resulting in better system performance. However, if any program writes to this memory area, a system error may result. The settings are: Enabled and Disabled (Default).

Memory Hole At 15M-16M

You can reserve this area of system memory for ISA adapter ROM. When this area is reserved, it cannot be cached. The user information of peripherals that need to use this area of system memory usually discusses their memory requirements. The settings are: Enabled and Disabled (Default).

Delayed Transaction

The chipset has an embedded 32-bit posted write buffer to support delay transactions cycles. Select Enabled to support compliance with PCI specification version 2.1. The settings are: Enabled (Default) and Disabled.

4.1.5 Integrated Peripherals

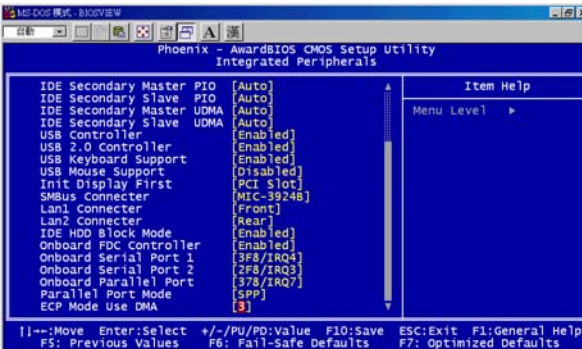
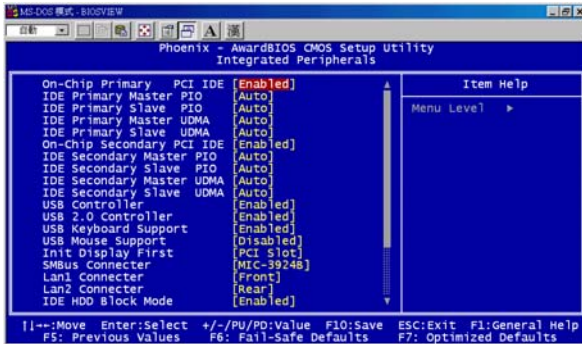

Figure 4.5: Integrated Peripherals setup screen

On-Chip Primary/Secondary PCI IDE

The integrated peripheral controller contains an IDE interface with support for two IDE channels. Select Enabled to activate each channel separately. The settings are: Enabled (Default) and Disabled.

IDE Primary/Secondary Master/Slave PIO

The four IDE PIO (Programmed Input/Output) fields let you set a PIO mode (0-4) for each of the four IDE devices that the onboard IDE interface supports. Modes 0 through 4 provide successively increased performance. In Auto mode, the system automatically determines the best mode for each device. The settings are: Auto (Default), Mode 0, Mode 1, Mode 2, Mode 3, Mode 4.

IDE Primary/Secondary Master/Slave UDMA

Ultra DMA/33 implementation is possible only if your IDE hard drive supports it and the operating environment includes a DMA driver (Windows 95 OSR2 or a third-party IDE bus master driver). If your hard drive and your system software both support Ultra DMA/33 and Ultra DMA/66 and Ultra DMA/100, select Auto to enable BIOS support. The settings are: Auto (Default), Disabled.

USB Controller

Select Enabled if your system contains a Universal Serial Bus (USB) 1.1 controller. The settings are: Enabled (Default), Disabled.

USB 2.0 Controller

Select Enabled if your system contains a Universal Serial Bus (USB) 1.1/2.0 controller. The settings are: Enabled (Default), Disabled.

USB Keyboard/Mouse Support

Select Enabled if you use USB KB/Mouse in DOS mode.

Init Display First

User can choose display priority on either peripheral PCI slot or on board VGA chip. There are 2 options: PCI slot (Default) and On board.

SMBus Connector

Users can select IPMI source and application as below.

Source	connected CMM
PCF8584T	MIC-3924B
Hardware Monitor 83782D	MIC-3924A
BMC (PMC type) (Reserved)	CMM (Reserved)

There are 3 options: MIC-3924B (Default), MIC-3924A and CMM.

LAN 1 Connector

The item allows you to choose LAN1 connective way. There are 3 options: Front (Default), 2.16 and Rear

LAN 2 Connector

The item allows you to choose LAN2 connective way. There are 2 options: 2.16 and Rear (Default)

IDE HDD Block Mode

Block mode is also called block transfer, multiple commands, or multiple sector read/write. If your IDE hard drive supports block mode (most new drives do), select Enabled for automatic detection of the optimal number of block read/writes per sector the drive can support. The settings are: Enabled (Default), Disabled.

Onboard FDC Controller

Select Enabled if your system has a floppy disk controller (FDD) installed on the system board and you wish to use it. If you install add-on FDC or the system has no floppy drive, select Disabled in this field. The settings are: Enabled (Default) and Disabled.

Onboard Serial Port 1/Port 2

Select an address and corresponding interrupt for the first and second serial ports. The Serial Port 1 settings are: 3F8/IRQ4 (Default), 2E8/IRQ3, 3E8/IRQ4, 2F8/IRQ3, Disabled, Auto.

The Serial Port 2 settings are: 3F8/IRQ4, 2E8/IRQ3, 3E8/IRQ4, 2F8/IRQ3 (Default), Disabled, Auto.

Onboard Parallel Port

There is a built-in parallel port on the on-board Super I/O chipset that provides Standard, ECP, and EPP features. It has the following options: Disabled, 3BCH/IRQ7 (Default), 278H/IRQ5 , 378H/IRQ7 and Disable

Parallel Port Mode

SPP (Default)	Standard Parallel Port
EPP1.9+SPP	Support both the SPP and EPP1.9 modes
ECP	Extended Capability Port
EPP1.9+ECP	Support both the ECP and EPP1.9 modes
Printer	Support Printer modes
EPP1.7+SPP	Support both the SPP and EPP1.7 modes
EPP1.7+ECP	Support both the ECP and EPP1.7 modes

ECP Mode Use DMA

The options: 1 and 3 (Default)

4.1.6 Power Management Setup

The Power Management Setup allows you to configure you system to most effectively save energy while operating in a manner consistent with your own style of computer use.

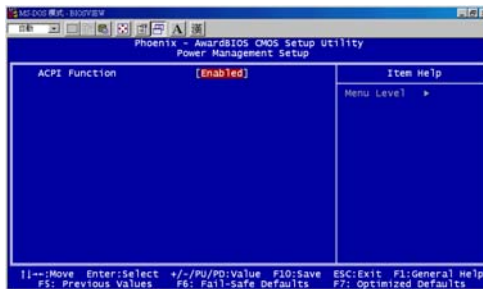

Figure 4.6: Power management setup screen

ACPI Function

This category allows you to select ACPI power management effective or not. The options: Enabled (Default) and Disabled.

4.1.7 PNP/PCI Configuration Setup

This section describes configuring the PCI bus system. PCI, or Personal Computer Interconnect, is a system which allows I/O devices to operate at speeds nearing the speed the CPU itself uses when communicating with its own special components. This section covers some very technical items and it is strongly recommended that only experienced users should make any changes to the default settings.

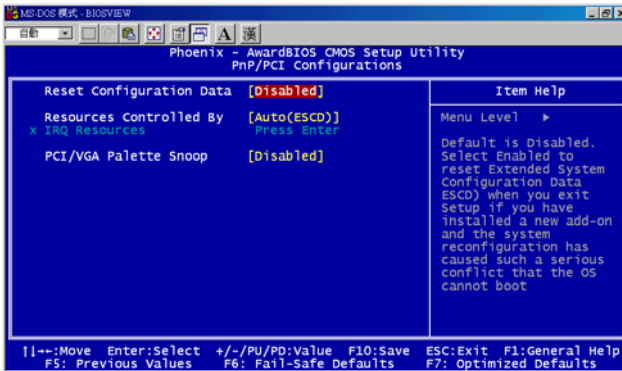

Figure 4.7: PnP/PCI configuration screen

Reset Configuration Data

Normally, you leave this field Disabled. Select Enabled to reset Extended System Configuration Data (ESCD) when you exit Setup if you have installed a new add-on and the system reconfiguration has caused such a serious conflict that the operating system can not boot. The settings are: Enabled and Disabled (Default).

Resource Controlled By

The Award Plug and Play BIOS has the capacity to automatically configure all of the boot and Plug and Play compatible devices. However, this capability means absolutely nothing unless you are using a Plug and Play

operating system such as Windows® 95/98. If you set this field to "manual" choose specific resources by going into each of the sub menu that follows this field (a sub menu is preceded by a "y"). The settings are: Auto (ESCD) (Default), Manual.

IRQ Resources

When resources are controlled manually, assign each system interrupt a type, depending on the type of device using the interrupt.

PCI/VGA Palette Snoop

Leave this field at Disabled. The settings are Enabled, Disabled (Default).

4.1.8 PC Health Status

This section shows the Status of you CPU, Fan, Warning for overall system status. This is only available if there is Hardware Monitor onboard.

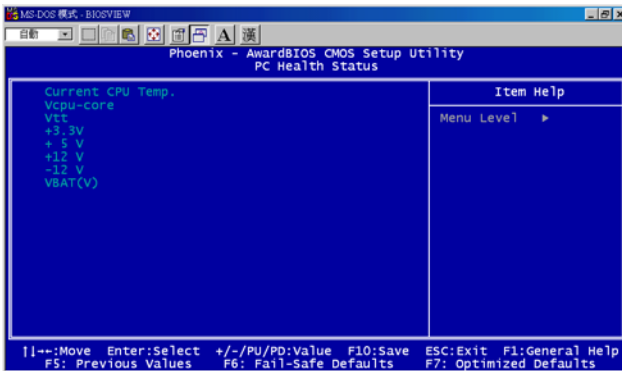

Figure 4.8: PC Health setup screen

Current CPU Temp./ Vcpu-core/Vtt/+3.3V/+5V/+12V/-12V/VBAT (V)

This show system health status.

4.1.9 Load Optimized Defaults

When you press <Enter> on this item, you get a confirmation dialog box with a message similar to:

Load Optimized Defaults (Y/N) ? N

Pressing 'Y' loads the default values that are factory settings for optimal performance system operations.

4.1.10 Set Password

To change, confirm, or disable the password, choose the "PASS-WORD SETTING" option from the Setup main menu and press [Enter]. The password can be at most 8 characters long. Remember, to enable this feature. You must first select the Security Option in the Advance BIOS FEATURES SETUP to be either "Setup" or "System." Pressing [Enter] again without typing any characters can disable the password setting function.

4.1.11 Save & Exit Setup

If you select this and press the [Enter] key, the values entered in the setup utilities will be recorded in the CMOS memory of the chipset. The microprocessor will check this every time you turn your system on and compare this to what it finds as it checks the system. This record is required for the system to operate.

4.1.12 Exit Without Saving

Selecting this option and pressing the [Enter] key lets you exit the Setup program without recording any new values or changing old ones.

Appendix

A

Watchdog Timer

Appendix A Watchdog Timer

A.1 Programming the Watchdog Timer

To program the watchdog timer, you must write a program which writes a value to I/O port address 443 (hex). This output value represents time interval. The value range is from 01 (hex) to FF (hex), and the related time interval is 1 sec. to 255 sec.

Data Time Interval

01 1 sec.

02 2 sec.

03 3 sec.

04 4 sec.

•

•

•

FF 255 sec.

After data entry, your program must refresh the watchdog timer by rewriting the I/O port 443. When you want to disable the watchdog timer, your program should read I/O port 043 (hex). The following example shows how you might program the watchdog timer in BASIC:

```
10 REM Watchdog timer example program
20 OUT &H443, data REM Start and restart the watchdog
30 GOSUB 1000 REM Your application task #1,
40 OUT &H443, data REM Reset the timer
50 GOSUB 2000 REM Your application task #2,
60 OUT &H443, data REM Reset the timer
70 X=INP (&H043) REM, Disable the watchdog timer
80 END

1000 REM Subroutine #1, your application task
•
•
•
```

1070 RETURN

2000 REM **Subroutine #2, your application task**

-
-
-

2090 RETURN.

Appendix

B

Pin Assignments

Appendix B Pin Assignments

B.1 J1 Connector

Table B.1: J1 connector

Pin	Z	A	B	C	D	E	F
25	GND	+5V	REQ64#	ENUM#	+3.3V	+5V	GND
24	GND	AD[1]	+5V	V(I/O)	AD[0]	ACK64#	GND
23	GND	+3.3V	AD[4]	AD[3]	+5V	AD[2]	GND
22	GND	AD[7]	GND	+3.3V	AD[6]	AD[5]	GND
21	GND	+3.3V	AD[9]	AD[8]	M66EN	C/BE[0]#	GND
20	GND	AD[12]	GND	V(I/O)	AD[11]	AD[10]	GND
19	GND	+3.3V	AD[15]	AD[14]	GND	AD[13]	GND
18	GND	SERR#	GND	+3.3V	PAR	C/BE[1]#	GND
17	GND	+3.3V	IPMB_SCL	IPMB_SDA	GND	PERR#	GND
16	GND	DEVSEL#	GND	V(I/O)	STOP#	LOCK#	GND
15	GND	+3.3V	FRAME#	IRDY#	BD/SEL#	TRDY#	GND
12-14	Key Area						
11	GND	AD[18]	AD[17]	AD[16]	GND	C/BE[2]#	GND
10	GND	AD[21]	GND	+3.3V	AD[20]	AD[19]	GND
9	GND	C/BE[3]#	N/C	AD[23]	GND	AD[22]	GND
8	GND	AD[26]	GND	V(I/O)	AD[25]	AD[24]	GND
7	GND	AD[30]	AD[29]	AD[28]	GND	AD[27]	GND
6	GND	REQ0#	GND	+3.3V	CLK0	AD[31]	GND
5	GND	N/C	N/C	RST#	GND	GNT0#	GND
4	GND	IPMB_PWR	Healthy#	V(I/O)	INTP	INTS	GND
3	GND	INTA#	INTB#	INTC#	+5V	INTD#	GND
2	GND	TCK	+5V	TMS	N/C	TDI	GND
1	GND	+5V	-12V	TRST#	+12V	+5V	GND

#: Low active

B.2 J2 Connector

Table B.2: J2 connector

Pin	Z	A	B	C	D	E	F
22	GND	GA4	GA3	GA2	GA1	GA0	GND
21	GND	CLK6	GND	RSV	RSV	RSV	GND
20	GND	CLK5	RSV	RSV	GND	RSV	GND
19	GND	RSV	GND	RSV (SMBB_SDA)	RSV (SMBB_SCL)	RSV	GND
18	GND	RSV	RSV	RSV	GND	RSV	GND
17	GND	RSV	GND	PRST#	REQ6#	GNT6#	GND
16	GND	RSV	RSV	RSV	GND	RSV	GND
15	GND	RSV	GND	RSV	REQ5#	GNT5#	GND
14	GND	AD[35]	AD[34]	AD[33]	GND	AD[32]	GND
13	GND	AD[38]	GND	V(I/O)	AD[37]	AD[36]	GND
12	GND	AD[42]	AD[41]	AD[40]	GND	AD[39]	GND
11	GND	AD[45]	GND	V(I/O)	AD[44]	AD[43]	GND
10	GND	AD[49]	AD[48]	AD[47]	GND	AD[46]	GND
9	GND	AD[52]	GND	V(I/O)	AD[51]	AD[50]	GND
8	GND	AD[56]	AD[55]	AD[54]	GND	AD[53]	GND
7	GND	AD[59]	GND	V(I/O)	AD[58]	AD[57]	GND
6	GND	AD[63]	AD[62]	AD[61]	GND	AD[60]	GND
5	GND	C/BE[5]#	64EN#	V(I/O)	C/BE[4]#	PAR64#	GND
4	GND	V(I/O)	RSV	C/BE[7]#	GND	C/BE[6]#	GND
3	GND	CLK4	GND	GNT3#	REQ4#	GNT4#	GND
2	GND	CLK2	CLK3	SYSEN#	GNT2#	REQ3#	GND
1	GND	CLK1	GND	REQ1#	GNT1#	REQ2#	GND

#: Low active

Note: GA[4...0] shall be used for geographic addressing on the backplane

B.3 J3 Connector

Table B.3: J3 connector

Pin	Z	A	B	C	D	E	F
19	GND	NC	NC	NC	NC	NC	GND
18	GND	MDIA0+	MDIA0-	GND	MDIA2+	MDIA2-	GND
17	GND	MDIA1+	MDIA1-	GND	MDIA3+	MDIA3-	GND
16	GND	MDIB0+	MDIB0-	GND	MDIB2+	MDIB2-	GND
15	GND	MDIB1+	MDIB1-	GND	MDIB3+	MDIB3-	GND
14	GND	NC	NC	NC	NC	NC	GND
13	GND	SDD0	SDD2	NC	NC	NC	GND
12	GND	SDD1	SDD3	SDD12	SDD4	SDD7	GND
11	GND	SDD5	SDD9	SDD13	SDD6	SDD8	GND
10	GND	SDD15	SDD14	SDIOR#	SDD10	SDD11	GND
9	GND	IDE_SDLED	CLK7	SDIOW#	SDREQ#	SDCS3#	GND
8	GND	IRQ15	SD_CBL_DET	SDA0	SDA1	SDA2	GND
7	GND	FD_DIR#	SDACK#	IDE_RST#	SIORDY	SDCS1#	GND
6	GND	SLIN-	INIT-	FD_WGATE#	FD_HDSEL#	FD_DS0#	GND
5	GND	PE	SLCT	FD_STEP#	FD_MTR0#	FD_WDATA#	GND
4	GND	ERR-	ACK-	FD_RDATA#	FD_WRTPR#	FD_TRK0#	GND
3	GND	STB-	AFD-	FD_DRVEN0	FD_INDEX#	FD_DSKCHG#	GND
2	GND	LPTD5	LPTD6	LPTD7	BUSY	FD_DRVEN1	GND
1	GND	LPTD0	LPTD1	LPTD2	LPTD3	LPTD4	GND

#: Low active

B.4 J5 Connector

Table B.4: J5 connector

Pin	Z	A	B	C	D	E	F
22	GND	ICH_RX+	ICH_RX-	GND	ICH_TX+	ICH_TX-	GND
21	GND	BMC_RX+	BMC_RX-	GND	BMC_TX+	BMC_TX-	GND
20	GND	GND	GND	USB1-	GND	GND	GND
19	GND	USB0-	GND	USB1+	GND	VGA_RED	GND
18	GND	USB0+	GND	GND	VGA-H	GND	GND
17	GND	GND	RIO_REQ7#	NC	GND	VGA_GREEN	GND
16	GND	USB_OC0#	RIO_GNT7#	GND	VGA-V	GND	GND
15	GND	USB_OC1#	RIOINSTALL#	RIO_HW_SW	GND	VGA_BLUE	GND
14	GND	NRLSD1	NRI1	RIO_HW_LED	ICH_LEDSPD	GND	GND
13	GND	NRTS1	NDTR1	BMC_LEDACT	ICH_LEDLINK	VGA_SCL	GND
12	GND	NTX1	NDSR1	BMC_LEDLINK	ICH_LEDACT	VGA_SDA	GND
11	GND	NRX1	NCTS1	NC	NC	MCLK	GND
10	GND	NDCD2	TX2	NRI2	NDRS2	MDAT	GND
9	GND	2RXD232	RX2	NDTR2	NCTS2	KBCLK	GND
8	GND	NRXD2	RTS2#	NTXD2	NRTS2	KBDAT	GND
7	GND	LINKA1G#	PORTA_LINK#	LINKB100#	PORTB_LINK#	+5V	GND
6	GND	LINKA100#	PORTA_ACT#	LINKB1G#	PORTB_ACT#	+5V	GND
5	GND	GND	GND	+3.3V	GND	GND	GND
4	GND	MDIB2-	MDIB2+	GND	MDIB3+	MDIB3-	GND
3	GND	MDIB0-	MDIB0+	GND	MDIB1+	MDIB1-	GND
2	GND	MDIA2-	MDIA2+	GND	MDIA3+	MDIA3-	GND
1	GND	MDIA0-	MDIA0+	GND	MDIA1+	MDIA1-	GND

B.5 System I/O Ports

Table B.5: System I/O ports

Address range (Hex)	Device
000-00F	Direct memory access controller
000-CF7	PCI bus
010-01F	Motherboard resources
020-021	Programmable interrupt controller
022-03F	Motherboard resources
040-043	System timer
044-05F	Motherboard resources
060-060	Standard 101/102-Key or Microsoft natural PS/2 keyboard
061-061	System speaker
062-063	Motherboard resources
064-064	Standard 101/102-Key or Microsoft natural PS/2 keyboard
065-06F	Motherboard resources
070-073	System CMOS / real time clock
074-07F	Motherboard resources
080-090	Direct memory access controller
091-093	Motherboard resources
094-09F	Direct memory access controller
0A0-0A1	Programmable interrupt controller
0A2-0BF	Motherboard resources
0C0-0DF	Direct memory access controller
0E0-0EF	Motherboard resources
0F0-0FF	Numeric data processor
170-177	Secondary IDE channel
1F0-1F7	Primary IDE channel
274-277	ISAPNP read data port
279-279	ISAPNP read data port
294-297	Motherboard resources
2F8-2FF	Communication port (COM2)
376-376	Secondary IDE channel
378-37F	Printer port (LPT1)
3B0-3BB	ATI Technologies Inc. Rage XL PCI
3C0-3DF	ATI Technologies Inc. Rage XL PCI
3F0-3F5	Standard floppy disk controller
3F6-3F6	Primary IDE channel
3F7-3F7	Standard floppy disk controller
3F8-3FF	Communication port (COM1)
447-44A	A-IPM driver
4D0-4D1	Motherboard resources
800-87F	Motherboard resources
A79-A79	ISAPNP read data port
0D00-FFFF	PCI bus

4000-40BF	Motherboard resources
5000-501F	Intel® 82801DB/DBM SMBus controller -24C3
C000-C0FF	ATI Technologies Inc. Rage XL PCI
C400-C43F	Intel® 82540EM based network connection #2
C800-C83F	Intel® 82540EM based network connection
CC00-CC3F	Intel® PRO/100 VE network connection
D000-D01F	Intel® 82801DB/DBM USB universal host controller - 24C4
D400-D41F	Intel® 82801DB/DBM USB universal host controller - 24C2
F000-F00F	Intel® 82801DB Ultra ATA Storage controller - 24CB

B.6 Interrupt Assignments

Table B.6: Interrupt assignments

Interrupt#	Interrupt source
IRQ 0 (ISA)	System timer
IRQ 1 (ISA)	Standard 101/102-Key or Microsoft natural PS/2 keyboard
IRQ 3 (ISA)	Communications port (COM2)
IRQ 4 (ISA)	Communications port (COM1)
IRQ 5 (ISA)	A-IPM driver
IRQ 8 (ISA)	System CMOS / real time clock
IRQ 9 (ISA)	Microsoft ACPI-Compliant system
IRQ 12 (ISA)	PS/2 compatible mouse
IRQ 13 (ISA)	Numeric data processor
IRQ 14 (ISA)	Primary IDE channel
IRQ 15 (ISA)	Secondary IDE channel

B.7 1st MB Memory Map

Table B.7: 1st MB memory map

Address range (Hex)	Device
F000h - FFFFh	System ROM
CC00h - EFFFh	Unused
CA00h - CBFFh	Used
C000h - C9FFh	Expansion ROM
B800h - BFFFh	CGA/EGA/VGA text
B000h - B7FFh	Unused
A000h - AFFFh	EGA/VGA graphics
0000h - 9FFFh	Base memory.

