



DIAMOND SYSTEMS CORPORATION

Janus-MM User Manual

Dual CAN ports, carrier for wireless and GPS modules

User Manual v1.05

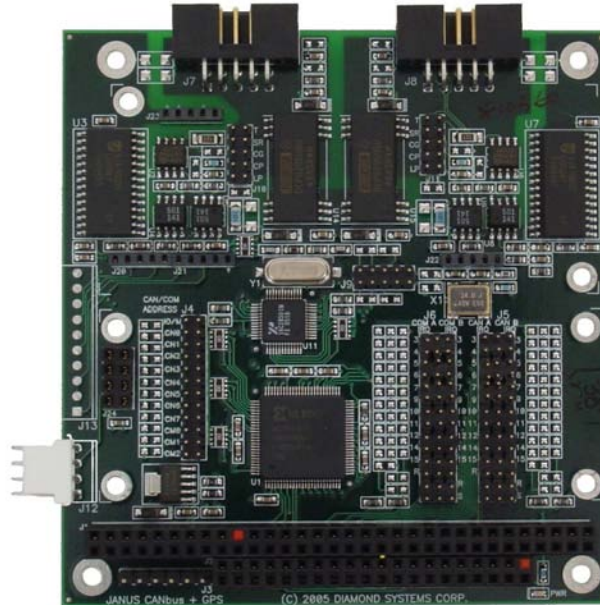

© Copyright 2006
Diamond Systems Corporation
1255 Terra Bella Ave.
Mountain View, CA 94043
Tel (650) 810-2500
Fax (650) 810-2525
www.diamondsystems.com

Table of Contents

INTRODUCTION.....	5
DESCRIPTION AND FEATURES.....	5
FUNCTIONAL OVERVIEW.....	5
BOARD DESCRIPTION.....	7
CONNECTOR SUMMARY.....	8
JUMPER SUMMARY.....	8
CONNECTORS.....	9
PC/104 ISA BUS.....	9
CAN PORTS.....	10
CAN PORT A.....	10
CAN PORT B.....	10
OPTIONAL CAN PORT A.....	11
OPTIONAL CAN PORT B.....	11
EXTERNAL MODEM ACCESS PORT.....	11
GPS INTERFACE.....	13
GPS BACKUP POWER AND PPS SIGNAL CONNECTOR.....	13
GPS RECEIVER CONNECTOR.....	13
SOCKETMODEM™ CONNECTORS.....	14
J20/J21 CONNECTOR PIN LAYOUT.....	14
J22 CONNECTOR PIN LAYOUT.....	16
J23 CONNECTOR PIN LAYOUT.....	16
BOARD CONFIGURATION.....	17
CAN CONFIGURATION.....	17
CAN BASE ADDRESS SELECTION.....	17
MEMORY BASE ADDRESS SELECTION.....	18
I/O BASE ADDRESS SELECTION.....	20
CAN IRQ SELECTION.....	22
CAN TERMINATION, SLEW RATE AND POWER SUPPLY SELECTION.....	22
UART CONFIGURATION.....	60
UART BASE ADDRESS SELECTION.....	60
UART IRQ SELECTION.....	61
UART FUNCTION AND POWER SELECTION.....	62
GPS CONFIGURATION - POWER SELECTION.....	64
MODULE INSTALLATION.....	65
MULTITECH SOCKETMODEM INSTALLATION.....	65
TRIMBLE LASSEN GPS MODULE INSTALLATION.....	67
PC/104 EXTENDER INSTALLATION INSTRUCTIONS.....	71
SPECIFICATIONS.....	72
CAN CIRCUIT.....	72

WIRELESS MODULES.....	72
GPS MODULES.....	72
GENERAL.....	72
ADDITIONAL INFORMATION.....	73
TECHNICAL SUPPORT.....	74
APPENDIX A.....	75
APPENDIX B.....	77

Figures

Figure 1: Janus-MM Block Diagram.....	6
Figure 2: Janus-MM Board Layout.....	7
Figure 3: J1 and J2 Connectors.....	9
Figure 4: J7 Connector.....	10
Figure 5: J8 Connector.....	10
Figure 6: J14 Connector.....	11
Figure 7: J15 Connector.....	11
Figure 8: J13 Connector.....	12
Figure 9: J12 Connector.....	13
Figure 10: SmartModem Connector Signals.....	14
Figure 11: J4 Base Address Jumper with Option Default CAN Settings.....	17
Figure 12: Memory Base Address Selection Example.....	20
Figure 13: J5 Jumper with Default Settings.....	22
Figure 14: J10 and J11 Jumpers with Default Settings.....	23
Figure 15: Power Supply Selection Example.....	60
Figure 16: J4 Base Address Jumper with Option Default UART Settings.....	60
Figure 17: J6 Jumper with Default Settings.....	61
Figure 18: Shared IRQ Selection.....	62

Figure 19: J9 Jumper with Default Settings.....	62
Figure 20: Socket Modem/GPS and Modem Power Selection.....	64
Figure 21: GPS Power Option Configuration.....	64
Figure 22: SocketModem Antenna Transition Cable (DSC #6970012).....	66
Figure 23: SocketModem Module.....	66
Figure 24: Panel (Bulkhead) Cutout for SocketModem Antenna Transition Cable.....	66
Figure 25: Janus-MM Board Layout.....	67
Figure 26: J16 Voltage Selection.....	67
Figure 27: Lassen SK II Transition Cable (DSC #6970003).....	69
Figure 28: Lassen SK II Module.....	69
Figure 29: Lassen iQ Transition Cable (DSC #6970002).....	69
Figure 30: Lassen iQ Module (Component Side).....	69
Figure 31: Lassen iQ Module Solder Side (enlarged view; see below).....	70
Figure 32: Lassen iQ Module with Antenna Transition Cable Installed.....	70
Figure 33: Panel (Bulkhead) Cutout for GPS iQ Antenna Transition Cable.....	70
Figure 34: Panel (Bulkhead) Cutout for GPS SKII Antenna Transition Cable.....	71

Introduction

This manual provides the information needed to use the JANUS-MM PC/104 carrier board, with dual CAN ports and provisions for installing a wireless modem and GPS module.

The manual includes:

- An introduction to the product.
- Hardware reference information.
- Installation and configuration information.
- Operational information for using the GPS and wireless modem.
- Board specifications.
- Additional resource information.

Description and Features

The JANUS-MM is a PC/104 board that provides a complete single-slot I/O solution for mobile applications requiring a CAN bus interface, GPS receiver and wireless communications.

The board includes dual CAN controllers, and provides options for including a MultiTech SocketModem™ and / or a Trimble Navigation GPS receiver. The JANUS-MM product has the following features:

- PC/104 form factor.
- +5V-only operation.
- Dual independently isolated CAN ports with full CAN2.0B functionality.
- Socket for optional Trimble Navigation Lassen SKII™ (8-channel) or Lassen iQ™ (12-channel) GPS receiver.
- Socket for optional MultiTech CDMA or GSM/GPRS SocketModem™.
- Jumper-selectable board configuration options.

Depending on the application, the board can be configured for any of the following communication options. Jumpers are provided to configure the desired option.

- GPS receiver on serial port 1 and serial port 2.
- GPS receiver on serial port 1 and SocketModem™ on serial port 2.
- GPS receiver on serial port 1 only.
- SocketModem™ on serial port 2 only.

Appendix A shows the available assemblies and development kits.

Appendix B lists the MultiTech SocketModems™ compatible with the JANUS-MM board.

Functional Overview

The board provides a standard PC/104 bus interface and dual CAN ports for interfacing to a CAN network. The dual CAN ports are opto-isolated, providing channel-to-channel and channel-to-system isolation.

Optional interfaces also support integration of a Trimble Navigation GPS and a wireless MultiTech SocketModem™. The GPS and wireless modem interface to the system through an Exar 16C2850 dual UART. An external TTL-level modem port is also available when the SocketModem™ is not being used.

Figure 1 shows the JANUS-MM functional block diagram.

The board is designed for applications that can involve wireless communications and use positional information, obtained from a GPS receiver, to control devices connected on a CAN bus.

The UART is a dual port device that connects serial port 1 to a GPS receiver and serial port 2 to either a second GPS receiver or a SocketModem™ depending on the application. Refer to Appendix A for a list of configuration options.

A dual 16C2850 UART provides for the various configurations options. UART port 1 connects to one of the two GPS receiver serial ports and port 2 connects to either the second GPS serial port or to a SocketModem™.

Jumpers are provided to configure board functionality, including IRQ selection.

The CAN bus interface, supporting CAN Specification 2.0 using the Philips SJA1000 CAN controller, implements the full CAN bus protocol.

The PC/104 bus connects to other stacked PC/104-standard components in the system, providing for CPU control of the board.

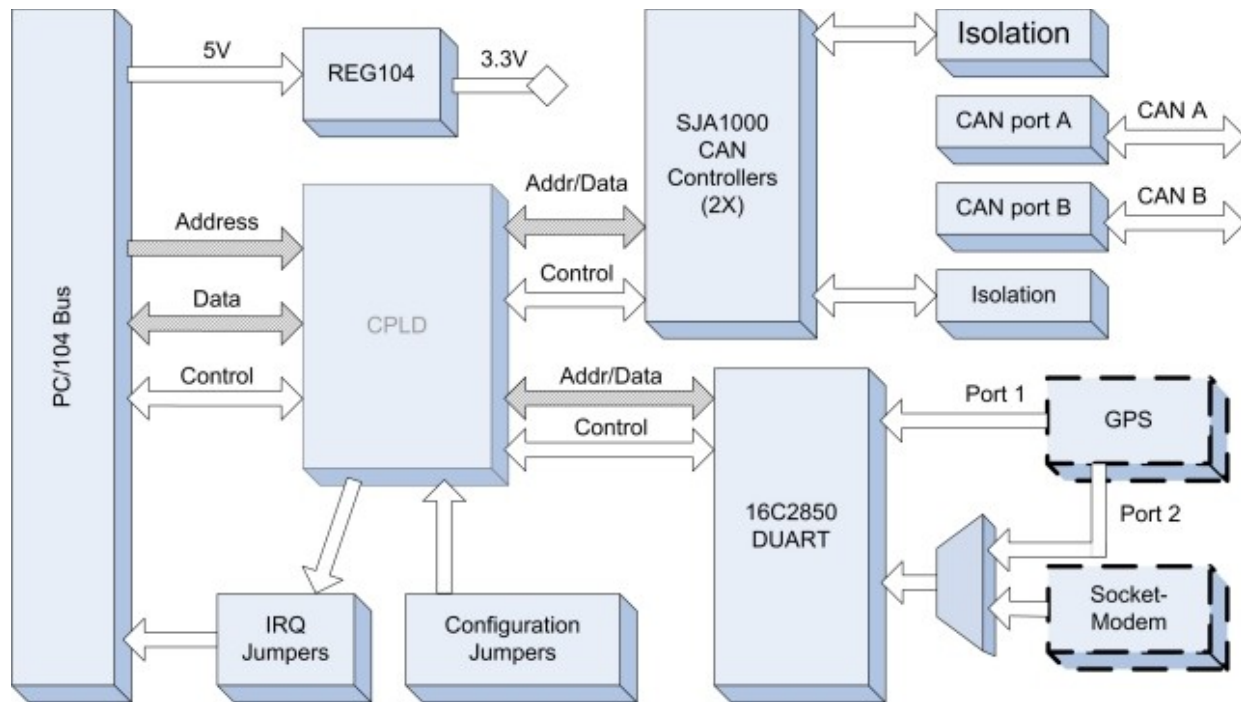

Figure 1: Janus-MM Block Diagram

NOTE: Sockets are provided for the Trimble Navigation GPS and SocketModem.

Board Description

Figure 2 shows the board connector and jumper locations. (Major components are shown for reference). Connectors showing an 'x' in the pin position are keyed to assure correct module insertion.

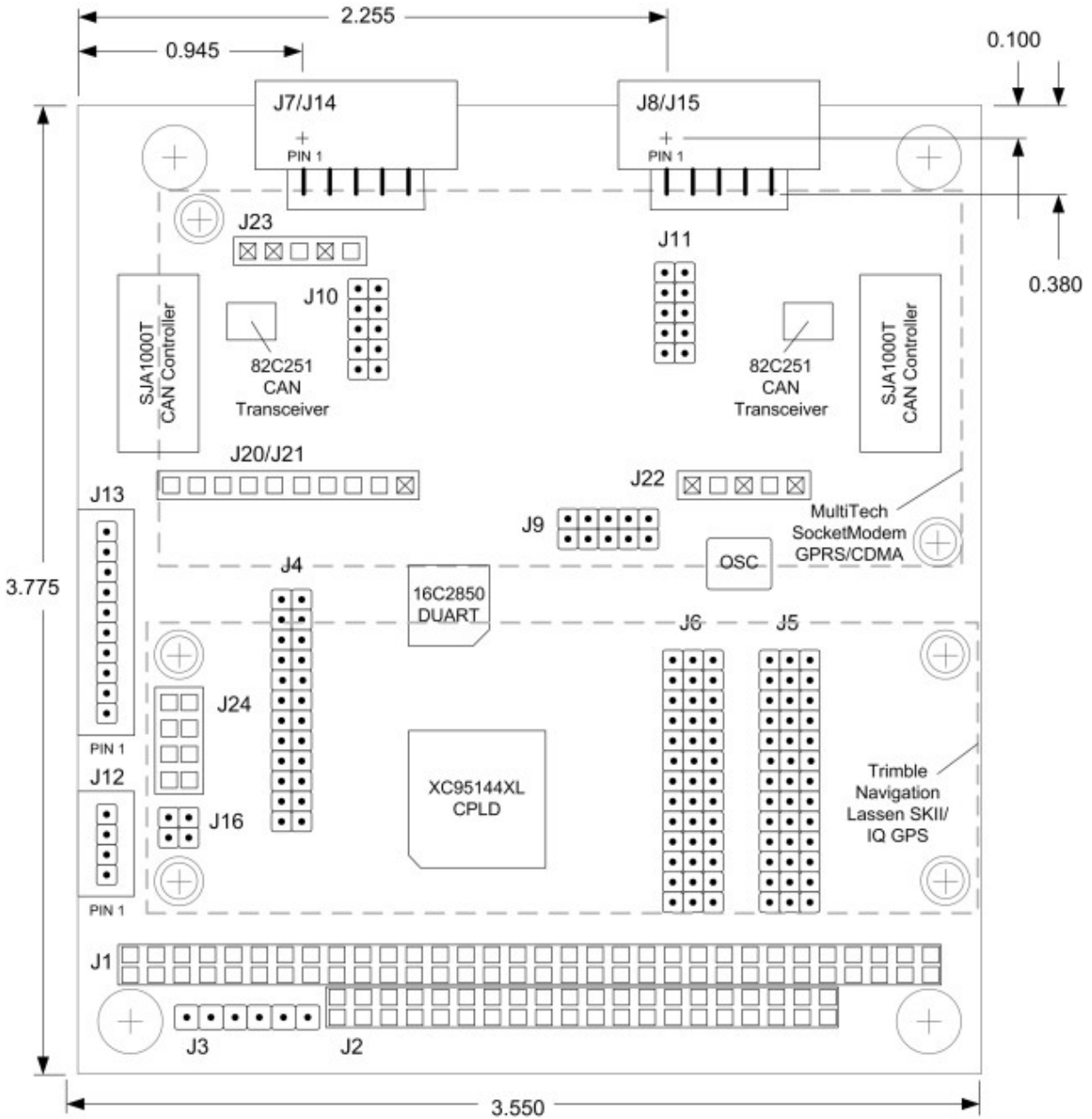

Figure 2: Janus-MM Board Layout

Connector Summary

The following table lists the connectors on the board.

Connector	Description	Manufacturer Part No.
J1	PC/104, ISA bus A,B 2x32, press-fit	EPT 962-60323-12
J2	PC/104, ISA bus C,D 2x20, press-fit	EPT 962-60203-12
J3	JTAG connector 1x6, straight, 0.1"	Aptos LHY-40S-VB-060/030
J7	CAN A port connector; 10-pin connector (replaces J14) 2x5, right-angle, shroud, 0.1"	Samtec TST-105-04-G-D-RA
J8	CAN B port connector; 10-pin connector (replaces J15) 2x5, right-angle, shroud, 0.1"	Samtec TST-105-04-G-D-RA
J12	GPS backup power and PPS signal 1x4, right-angle, Friction Lock, 0.1"	Tyco 640457-4
J13	Optional external modem access port 1x10, right-angle, Friction Lock, 0.1"	Samtec LCW-110-15-G-S-230-RP
J14	Optional CAN A port connector; 5-pin connector (replaces J7) 1x5, locking, 0.1"	Note: This is a non-standard connector for custom applications.
J15	Optional CAN A port connector; 5-pin connector (replaces J8) 1x5, locking, 0.1"	Note: This is a non-standard connector for custom applications.
J20-J23	SocketModem™ Card 1x5, straight, 2mm	Phyco 4220-1X5SF1
J24	GPS Receiver Card 2x4, straight	Samtec SLW-104-01-G-D

Jumper Summary

The following table lists the jumpers on the board.

Jumper	Description
J4	CAN Address selection
J5	CAN IRQ selection
J6	COM IRQ selection
J9	UART port B connection and modem power configuration
J10	CAN A power configuration
J11	CAN B power configuration
J16	GPS power selection

Connectors

This section describes the connectors on the JANUS-MM board.

PC/104 ISA Bus

Connectors J1 and J2 carry the ISA bus signals. Figure 3 shows the PC/104 A and B pin layout for J1, and the C and D pin layout for J2.

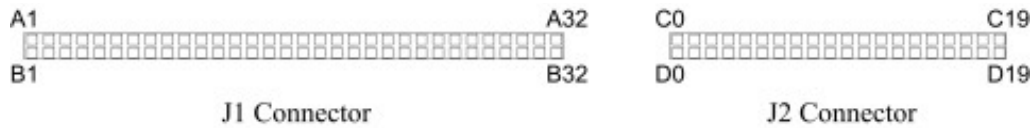

Figure 3: J1 and J2 Connectors

<i>J1 Connector Pinout</i>			
IOCHCHK-	A1	B1	GND
SD7	A2	B2	RESETDRV
SD6	A3	B3	+5V
SD5	A4	B4	IRQ9
SD4	A5	B5	-5V
SD3	A6	B6	DRQ2
SD2	A7	B7	-12V
SD1	A8	B8	ENDXFR-
SD0	A9	B9	+12V
IOCHRDY	A10	B10	keyed
AEN	A11	B11	SMEMW-
SA19	A12	B12	SMEMR-
SA18	A13	B13	IOW-
SA17	A14	B14	IOR-
SA16	A15	B15	DACK3-
SA5	A16	B16	DRQ3
SA14	A17	B17	DACK1-
SA13	A18	B18	DRQ1
SA12	A19	B19	REFRESH-
SA11	A20	B20	SYSCLK
SA10	A21	B21	IRQ7
SA9	A22	B22	IRQ6
SA8	A23	B23	IRQ5
SA7	A24	B24	IRQ4
SA6	A25	B25	IRQ3
SA5	A26	B26	DACK2-
SA4	A27	B27	TC
SA3	A28	B28	BALE
SA2	A29	B29	+5V
SA1	A30	B30	OSC
SA0	A31	B31	GND
GND	A32	B32	GND

<i>J2 Connector Pinout</i>			
GND	C0	D0	GND
SBHE-	C1	D1	MEMCS16--
LA23	C2	D2	IOCS16-
LA22	C3	D3	IRQ10
LA21	C4	D4	IRQ11
LA20	C5	D5	IRQ12
LA19	C6	D6	IRQ15
LA18	C7	D7	IRQ14
LA17	C8	D8	DACK0-
MEMR-	C9	D9	DRQ0
MEMW-	C10	D10	DACK5-
SD8	C11	D11	DRQ5
SD9	C12	D12	DACK6-
SD10	C13	D13	DRQ6
SD11	C14	D14	DACK7-
SD12	C15	D15	DRQ7
SD13	C16	D16	+5
SD14	C17	D17	MASTER-
SD15	C18	D18	GND
keyed	C19	D19	GND

CAN Ports

The CAN bus interface supports CAN Specification 2.0, implementing the full CAN bus protocol.

JANUS-MM provides connectors for the two CAN ports. These are 10-pin right-angle, shrouded connectors (J7, J8) for CAN ports A and B. Optionally, non-standard 5-pin connectors (J14 and J15, located under the shroud) are provided for custom applications.

Use jumper J10 to select either the internal or external CAN A power options on the J7 (J14) connector. Use jumper J11 to select either the internal or external CAN B power options on the J8 (J15) connector. (Refer to section of this document).

NOTE: Connectors J7/J8 are depicted viewing the connector from the top edge of the board looking down.

CAN Port A

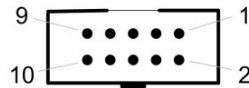

Figure 4: J7 Connector

-	1	2	GNDA_CAN
CANLA	3	4	CANHA
GNDA_ISO	5	6	-
-	7	8	+5VA_CAN
-	9	10	-

CAN Port B

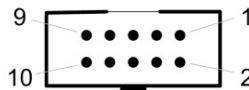

Figure 5: J8 Connector

-	1	2	GNDB_CAN
CANLB	3	4	CANHB
GNDB_ISO	5	6	-
-	7	8	+5VB_CAN
-	9	10	-

Optional CAN Port A

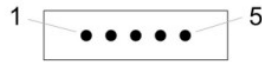

Figure 6: J14 Connector

1	GNDA_ISO
2	CANHA
3	CANLA
4	GNDA_CAN
5	+5VA_CAN

Optional CAN Port B

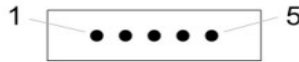

Figure 7: J15 Connector

1	GNDB_ISO
2	CANHB
3	CANLB
4	GNDB_CAN
5	+5VB_CAN

External Modem Access Port

Connector J13 is provided for connecting to any third-party TTL serial device. The signals for this connector are also used for the SocketModem™. Therefore, this connector cannot be used if the SocketModem™ is installed.

Note: The modem signals are TTL level signals.



Figure 8: J13 Connector

1	DTR_MDM
2	DCD_MDM
3	CTS_MDM
4	DSR_MDM
5	RI_MDM
6	TXD_MDM
7	RXD_MDM
8	RTS_MDM
9	+5V
10	GND

GPS Interface

GPS Backup Power and PPS Signal Connector

Connector J24 provides for connecting the Trimble Navigation GPS receiver card. Both the Lassen SKII™ and Lassen iQ™ cards are supported. Refer to the vendor documentation for additional information on the hardware and software interface to the GPS. (See the Additional Information Section.)

Connector J12 provides two pins for GPS backup power and the pulse-per-second (PPS) signal, and two ground signals are also available.

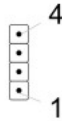

Figure 9: J12 Connector

1	GND
2	GPS_BKUPPWR
3	GPS_PPS
4	GND

GPS Receiver Connector

Connector J24 provides for connecting the Trimble Navigation GPS receiver card. Both the Lassen SKII™ card and the Diamond Systems card using the Lassen iQ™ module are supported. Refer to the vendor documentation for on the hardware and software interface to the GPS.

1	TXD Port2
2	Vcc
3	TXD Port1
4	Backup Power
5	RXD Port1
6	PPS
7	RXD Port2
8	GND

SocketModem™ Connectors

Connectors J20, J21, J22 and J23 provide for connecting the MultiTech SocketModem™ CDMA or SocketModem™ GPRS card. Refer to the vendor documentation in the Additional Information Section for the hardware and software interface to the wireless modem.

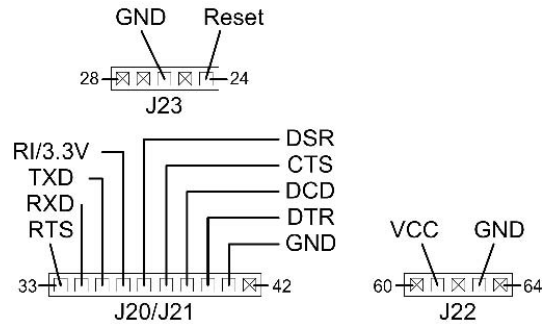

Figure 10: SmartModem™ Connector Signals

J20/J21 Connector Pin Layout

33	RTS
34	RXD
35	TXD
36	RI/3.3V
37	DSR
38	CTS
39	DCD
40	DTR
41	GND
42	keyed

J22 Connector Pin Layout

60	keyed
61	VCC
62	keyed
63	GND
64	keyed

J23 Connector Pin Layout

24	Reset
25	keyed
26	GND
27	keyed
28	keyed

Board Configuration

The JANUS-MM board has the following jumper-selectable configuration options.

- CAN base memory address and base I/O address
- CAN IRQ
- CAN termination
- CAN slew rate
- CAN power supply
- UART base memory address and base I/O address
- UART IRQ
- UART port B function
- Modem power supply
- GPS power supply

NOTE: In the figures in this section, jumpered pins are shown as a shaded connector.

CAN Configuration

This section presents the following configurable CAN options.

- Memory and I/O base address selection
- IRQ selection
- CAN bus termination
- Slew rate
- Power supply selection

CAN Base Address Selection

Use pin sets CN0-CN7 of jumper J4 to set the CAN base address using one of the following address spaces.

- Memory address space
- I/O address space

Note: The pin layout shows the default factory jumper settings for the CAN memory configuration options.

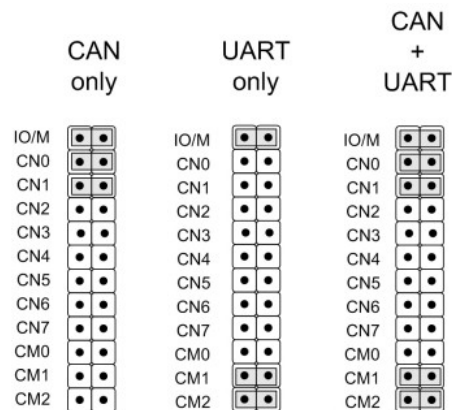

Figure 11: J4 Base Address Jumper with Option Default CAN Settings

Use the J4 IO/M jumper to select either memory or I/O address space.

J4	
Jumpered Pins	Function
IO/M	Out: Select I/O base address In: Select memory base address (default)

Memory Base Address Selection

If you have selected to access CAN through memory base addresses, the CAN memory base address is specified using eight jumpers, CN0-CN7, corresponding to address bits A10-A17, respectively.

Jumper	CN7	CN6	CN5	CN4	CN3	CN2	CN1	CN0
Address bit	A17	A16	A15	A14	A13	A12	A11	A10

Address bits A18 and A19 are always set; see the address mapping table, below, for the resulting base address values.

The following table shows the jumper-to-address mapping for memory space.

Base Address	CN7	CN6	CN5	CN4	CN3	CN2	CN1	CN0
C0000h	In	In	In	In	In	In	In	In
C0400h	In	In	In	In	In	In	In	Out
C0800h	In	In	In	In	In	In	Out	In
C0C00h	In	In	In	In	In	In	Out	Out
C1000h	In	In	In	In	In	Out	In	In
C2000h	In	In	In	In	Out	In	In	In
C3000h	In	In	In	In	Out	Out	In	In
C4000h	In	In	In	Out	In	In	In	In
C5000h	In	In	In	Out	In	Out	In	In
C6000h	In	In	In	Out	Out	In	In	In
C7000h	In	In	In	Out	Out	Out	In	In
C8000h	In	In	Out	In	In	In	In	In
C9000h	In	In	Out	In	In	Out	In	In
CA000h	In	In	Out	In	Out	In	In	In
CB000h	In	In	Out	In	Out	Out	In	In
CC000h	In	In	Out	Out	In	In	In	In
CD000h	In	In	Out	Out	In	Out	In	In
CE000h	In	In	Out	Out	Out	In	In	In
CF000h	In	In	Out	Out	Out	Out	In	In
D0000h	In	Out	In	In	In	In	In	In
D1000h	In	Out	In	In	In	Out	In	In
D2000h	In	Out	In	In	Out	In	In	In
D3000h	In	Out	In	In	Out	Out	In	In
D4000h	In	Out	In	Out	In	In	In	In
D5000h	In	Out	In	Out	In	Out	In	In
D6000h	In	Out	In	Out	Out	In	In	In
D7000h	In	Out	In	Out	Out	Out	In	In
D8000h	In	Out	Out	In	In	In	In	In

<i>Base Address</i>	<i>CN7</i>	<i>CN6</i>	<i>CN5</i>	<i>CN4</i>	<i>CN3</i>	<i>CN2</i>	<i>CN1</i>	<i>CN0</i>
D8400h	In	Out	Out	In	In	In	In	Out
D8800h	In	Out	Out	In	In	In	Out	In
D8C00h	In	Out	Out	In	In	In	Out	Out
D9000h	In	Out	Out	In	In	Out	In	In
DA000h	In	Out	Out	In	Out	In	In	In
DB000h	In	Out	Out	In	Out	Out	In	In
DC000h	In	Out	Out	Out	In	In	In	In
DD000h	In	Out	Out	Out	In	Out	In	In
DE000h	In	Out	Out	Out	Out	In	In	In
DF000h	In	Out	Out	Out	Out	Out	In	In
E0000h	Out	In	In	In	In	In	In	In
E1000h	Out	In	In	In	In	Out	In	In
E2000h	Out	In	In	In	Out	In	In	In
E3000h	Out	In	In	In	Out	Out	In	In
E4000h	Out	In	In	Out	In	In	In	In
E5000h	Out	In	In	Out	In	Out	In	In
E6000h	Out	In	In	Out	Out	In	In	In
E7000h	Out	In	In	Out	Out	Out	In	In
E8000h	Out	In	Out	In	In	In	In	In
E9000h	Out	In	Out	In	In	Out	In	In
EA000h	Out	In	Out	In	Out	In	In	In
EB000h	Out	In	Out	In	Out	Out	In	In
EC000h	Out	In	Out	Out	In	In	In	In
ED000h	Out	In	Out	Out	In	Out	In	In
EE000h	Out	In	Out	Out	Out	In	In	In
EF000h	Out	In	Out	Out	Out	Out	In	In
F0000h	Out	Out	In	In	In	In	In	In
F1000h	Out	Out	In	In	In	Out	In	In
F2000h	Out	Out	In	In	Out	In	In	In
F3000h	Out	Out	In	In	Out	Out	In	In
F4000h	Out	Out	In	Out	In	In	In	In
F5000h	Out	Out	In	Out	In	Out	In	In
F6000h	Out	Out	In	Out	Out	In	In	In
F7000h	Out	Out	In	Out	Out	Out	In	In
F8000h	Out	Out	Out	In	In	In	In	In
F9000h	Out	Out	Out	In	In	Out	In	In
FA000h	Out	Out	Out	In	Out	In	In	In
FB000h	Out	Out	Out	In	Out	Out	In	In
FC000h	Out	Out	Out	Out	In	In	In	In
FD000h	Out	Out	Out	Out	In	Out	In	In
FE000h	Out	Out	Out	Out	Out	In	In	In
FF000h default	Out	Out	Out	Out	Out	Out	In	In
FF400h	Out	Out	Out	Out	Out	Out	In	Out
FF800h	Out	Out	Out	Out	Out	Out	Out	In
FFC00h	Out	Out	Out	Out	Out	Out	Out	Out

Note: Address bits A18 and A19 have a value of one (1).

The base address is specified for CAN port A. The base address for CAN port B is located at port A base address + 00200h, as shown in the following table.

<i>CAN Port</i>	<i>Base Address</i>
A	(Jumpered base address)
B	(Jumpered base address) + 00200h

For example, to configure the memory base address of port A to D0000h, jumper IO/M, CN0-CN5 and CN7. The base address of port B is then D0200h. The example is shown in the following figure.

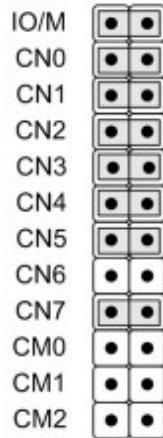

Figure 12: Memory Base Address Selection Example

Reset ports A and B by writing to any of the memory addresses shown in the following table.

<i>CAN Port</i>	<i>CAN Reset Address Range</i>
A	00100h – 001FFh
B	00300h – 003FFh

I/O Base Address Selection

If you have selected I/O addressing to access the CAN controllers, the CAN controller have a 64-byte I/O address space (32 bytes per port). The I/O base address is specified using four jumpers, CN0-CN3, corresponding to I/O address bits A9-A6, respectively.

<i>Jumper</i>	CN3	CN2	CN1	CN0
<i>Address bit</i>	A9	A8	A7	A6

The following table shows the jumper-to-address mapping for I/O space. (Set the I/O base address in the same way as shown in the example, above, for setting the memory base address).

<i>Base Address</i>	<i>CN3</i>	<i>CN2</i>	<i>CN1</i>	<i>CN0</i>
0000h	In	In	In	In
0040h	In	In	In	Out
0080h	In	In	Out	In
00C0h	In	In	Out	Out
0100h	In	Out	In	In
0140h	In	Out	In	Out
0180h	In	Out	Out	In
01C0h	In	Out	Out	Out
0200h	Out	In	In	In
0240h	Out	In	In	Out
0280h	Out	In	Out	In
02C0h	Out	In	Out	Out
0300h	Out	Out	In	In
0340h	Out	Out	In	Out
0380h	Out	Out	Out	In
03C0h	Out	Out	Out	Out

Note: Address bits A11-A15 have a value of zero (0).

The I/O base address is specified for CAN port A. The I/O base address for CAN port B is located at port A I/O base address + 0020h, as shown in the following table.

<i>CAN Port</i>	<i>Base Address</i>
A	(Jumpered I/O base address)
B	(Jumpered I/O base address) + 0020h

CAN IRQ Selection

Use jumper J5 to specify the IRQ for both CAN ports. The following diagram shows the jumper pin layout.

(The default jumper settings shown in the diagram apply to the CAN+UART and CAN-only configuration options).

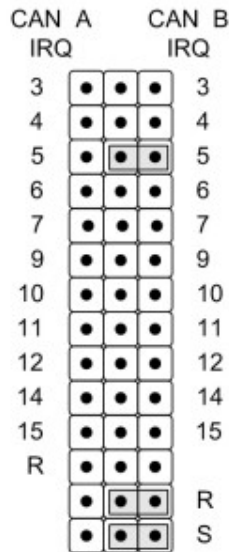

Figure 13: J5 Jumper with Default Settings

The pin label corresponds to the IRQ (IRQ3-IRQ7, IRQ9-IRQ12, IRQ14, IRQ15).

The center column of pins corresponds to the IRQ. Assign the IRQ to CAN port A (CAN A) by shorting the center pin and the pin to its left. Similarly, assign the IRQ to CAN port B (CAN B) by shorting the center pin and the pin to its right. In the diagram, above, IRQ4 is assigned to CAN port A and IRQ3 is assigned to CAN port B.

To share the same IRQ on both CAN ports A and B, short the pin labeled 'S' to its corresponding center pin, and jumper the desired IRQ for either CAN ports A or B. Refer to for an example of the use of the 'S' pin.

To associate the pull-down resistor on this board with the IRQ for the CAN port, short the 'R' pin of the CAN port and the center pin.

Note: Only one pull-down resistor is allowed per IRQ in the entire PC/104 stack.

CAN Termination, Slew Rate and Power Supply Selection

Jumpers J10 and J11 provide CAN termination, slew rate and power supply selection for both CAN ports; J10 is used to configure CAN port A and J11 is used to configure CAN port B. The following diagram shows the jumper pin layout.

(The default jumper settings shown in the diagram apply to the CAN+UART and CAN-only configuration options).

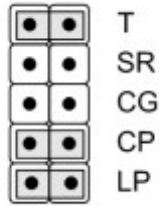

Figure 14: J10 and J11 Jumpers with Default Settings

<i>Jumpered Pins</i>	<i>Function</i>
T	CAN termination. In: Board terminates CAN bus (default). Out: Board does not terminate CAN bus.
SR	Slew rate selection. In: High-speed operating mode. Out: Slope-controlled operating mode (default).
CG	CAN power supply selection. GND from CAN
CP	+5V from CAN; power supply over CAN bus powers the local port (default)
LP	+5V from DCP; local isolated power supply is used to power the CAN bus (default)

CAN Termination

Shorting the CAN termination jumper (T) puts a 120-Ohm resistor between CANL and CANH.

Note: The CAN bus should be terminated only at the ends of the bus, for a maximum of two terminations on the bus.

CAN Slew Rate

For *high-speed* operation, the transmitter output transistors are switched on and off as fast as possible. In this mode, the rise and fall slope is not limited. Use of a shielded cable is recommended to avoid RFI problems. The *slope control* operating mode allows the use of an unshielded twisted pair or a parallel pair of wires as bus lines by programming the rise and fall slope with a resistor connected to ground.

Short the slew rate jumper (SR) to select high-speed operating mode.

CAN Power Supply Selection

Because the CAN ports and transceivers are isolated, it is possible that two different ports will not communicate properly if the voltage differential is too great. The J10/J11 jumpers (CG, CP, LP) are provided to attach/remove these power rails. One way to ensure that the two ends of the CAN communication are within voltage range is to share the same ground, or use one power supply for both terminals. Also, the local supply may be used to power the bus, and the local port may be powered from the bus.

The following options are provided to attach/remove the power rails.

- Power from the local isolated power supply (DCP).

- Power from a remote power supply, over the CAN bus.
- Power from the local power supply which is also used to power remote ports.

The following figure shows the jumper settings for the power supply options.

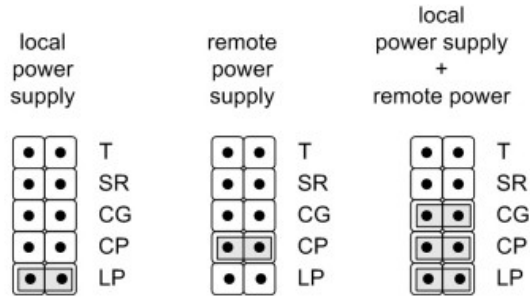

Figure 15: Power Supply Selection Example

UART Configuration

The UART is a dual port device that connects to GPS serial port 1 and to either GPS serial port 2 or the SocketModem™, depending on the application.

This section presents the following UART configuration topics.

- Base address selection
- IRQ selection
- Function and power selection

UART Base address selection

The base address uniquely assigns the UART address within the PC/104 system. Use pin sets CM0, CM1 and CM2 of jumper J4 to set the UART base address.

Note: The pin layout shows the default factory jumper settings for the dual UART memory configuration options. (The IO/M jumper only applies to CAN memory addressing).

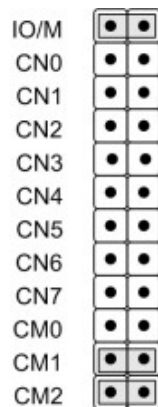

Figure 16: J4 Base Address Jumper with Option Default UART Settings

Jumpers CM0-CM2 select the dual UART address space. The following table shows the address map for the jumper configurations.

<i>UART port A Base Address</i>	<i>UART port B Base Address</i>	<i>CM2</i>	<i>CM1</i>	<i>CM0</i>
03F8h	02F8h	In	In	In
03E8h	02E8h	In	In	Out
0380h	0388h	In	Out	In
0240h	0248h	In	Out	Out
0100h	0108h	Out	In	In
0120h	0128h	Out	In	Out
0140h	0148h	Out	Out	In
0160h	0168h	Out	Out	Out

UART IRQ Selection

The UART can be configured to generate interrupts using a particular IRQ with the PC/104 system.

Use jumper J6 to select the IRQ for both UARTs. The following diagram shows the jumper pin layout.

Note: The default jumper settings shown in the diagram apply to the CAN+UART and UART-only configuration options.

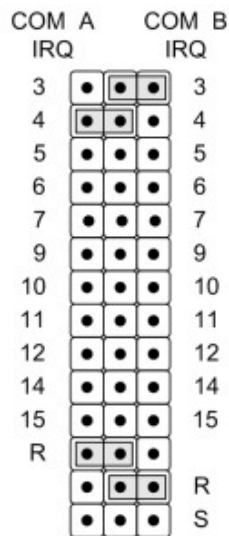

Figure 17: J6 Jumper with Default Settings

The pin label corresponds to the selectable IRQ (IRQ3-IRQ7, IRQ9-IRQ12, IRQ14, IRQ15).

The center column of pins corresponds to the IRQ. Assign the IRQ to UART A (COM A) by shorting the center pin and the pin to its left. Similarly, assign the IRQ to UART port B (COM B) by shorting the center pin and the pin to its right. In the diagram, above, IRQ4 is assigned to UART A and IRQ3 is assigned to UART port B.

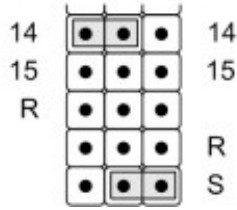

Figure 18: Shared IRQ Selection

To share the same IRQ on both UARTs A and B, short the pin labeled ‘S’ to its corresponding center pin, and jumper the desired IRQ for either UARTs A or B. In the example, below, IRQ 14 is assigned to both UART A and UART B.

Note: Only one pull-down resistor is allowed per IRQ in the entire PC/104 stack.

UART Function and Power Selection

UART serial port B can be used to communicate with either a GPS receiver, for applications that require two GPS receivers, or the SocketModem™.

Jumper J9 provides the mechanism for selecting UART port B to communicate with either the SocketModem™ or GPS, and for selection the modem power option.

The following power options are provided.

- +5V is required for all current models of the wireless SocketModems.
- +3.3V is provided for future devices.

Note: The default jumper settings shown in the diagram apply to the CAN+UART and UART-only options.



Figure 19: J9 Jumper with Default Settings

<i>Jumpered Pins</i>	<i>Function</i>
MDM (pair)	Bottom position: Socket modem transmit (Tx) (default) Top position: Socket modem receive (Rx) (default)
GPS (pair)	Bottom position: GPS port 2 transmit (Tx) Top position: GPS port 2 receive (Rx)
3V3	Select +3.3V modem power
5V	Select +5V modem power (default)

Note: The transmit (Tx) and receive (Rx) pair of jumpers must both select either MDM or GPS.

The following figure shows examples for selecting either the socket modem or GPS, and for selecting either the +3.3V or +5V power supply.

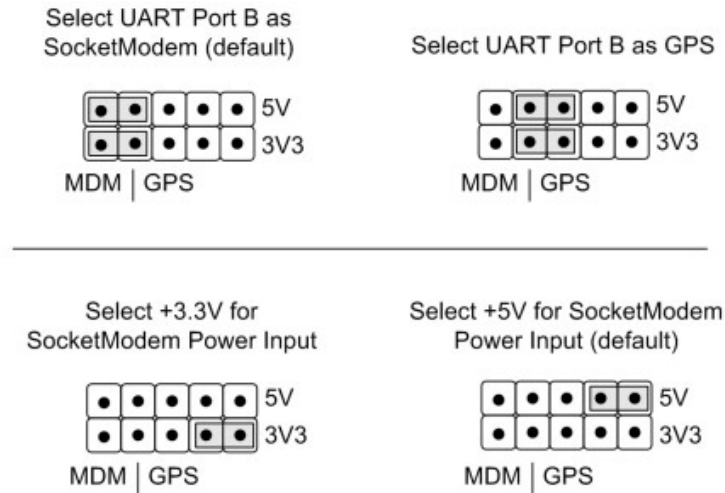

Figure 20: Socket Modem/GPS and Modem Power Selection

GPS Configuration - Power Selection

Either the Trimble Lassen SKII™ or iQ™ GPS modules may be installed. The different GPS modules require different voltages, which are configurable using jumper J16.

- +5V is required for the Trimble Lassen SKII™ module.
- +3.3V is required for the Trimble Lassen iQ™ module and daughterboard.

The following figure shows the jumper configuration for the GPS power options.

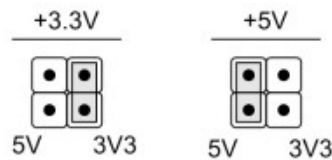

Figure 21: GPS Power Option Configuration

Module Installation

This section describes the steps for installing the following components.

- MultiTech SocketModem™ module
- Trimble Lassen GPS modules
- PC/104 extender

Note: Always insure that you have a clean and clear work space and that you are properly grounded, wearing an anti-static wrist strap.

MultiTech SocketModem™ Installation

Install the SocketModem™ before you install the Janus-MM card onto a PC/104 stack. You will need access to the bottom of the Janus-MM card to secure the standoffs in place.

Set all jumpers as required for CAN bus operation and to control the dual UART accessing the SocketModem™ BEFORE you install any modules on the Janus-MM board. If jumper changes are required, you will need to remove the module to alter the jumper settings.

If you intend to place a PC/104 card on the stack ABOVE the Janus-MM card after you have installed the SocketModem™, you will also need to install a PC/104 Extender (DSC # 6801017) onto the Janus-MM card before installing the PC/104 card above the Janus module. See PC/104 Extender Installation Instructions, below, for instructions on installing the PC/104 Extender.

1. In the Janus-MM SocketModem™ Hardware Kit, DSC #680016, find the following items.
 - a. 2 each 4-40 x 3/16" Pan Head screws (DSC #681043)
 - b. 2 each 4-40 hex nuts (DSC #682041)
 - c. 2 each 4-40 x 7mm L hex M/F standoffs (DSC #684046)
2. Place the female end of the 7mm hex standoffs through the mounting holes in the Janus-MM PCB shown in Figure 25, from the component side to the solder side, and secure each standoff with a hex nut on the solder side. Do not over-tighten.
3. Place the SocketModem™ on the Janus-MM PCB so that the three connectors on the SocketModem™ match up with and insert into connectors J21, J22 and J23 on the Janus-MM module. Insure that the two mounting holes on the SocketModem™ line up with the top of the two hex standoffs. Press firmly to seat the SocketModem™ on the Janus-MM PCB.
4. Install the two Pan Head Screws from the top side of the SocketModem™ through the SocketModem™ module mounting holes and into the hex standoffs. Tighten securely, but do not over-tighten.
5. Install the antenna transition cable (DSC #6970012), if necessary, directly to the SocketModem™ antenna connector (See Figure 23). The antenna transition cable snaps into position.
6. Attach the antenna, itself, (DSC # 6970011) to the antenna transition cable. The antenna screws onto the transition cable.

The SocketModem™ antenna transition cable connects to the antenna mounted on an enclosure. The enclosure cutout dimensions for the antenna mount are shown in Figure 24.



Figure 22: SocketModem Antenna Transition Cable (DSC #6970012)



Figure 23: SocketModem Module

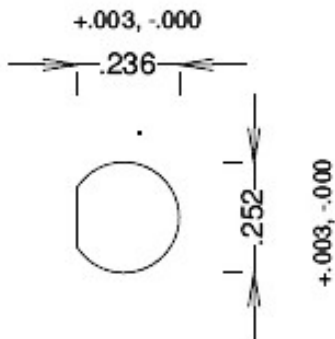

Figure 24: Panel (Bulkhead) Cutout for SocketModem Antenna Transition Cable

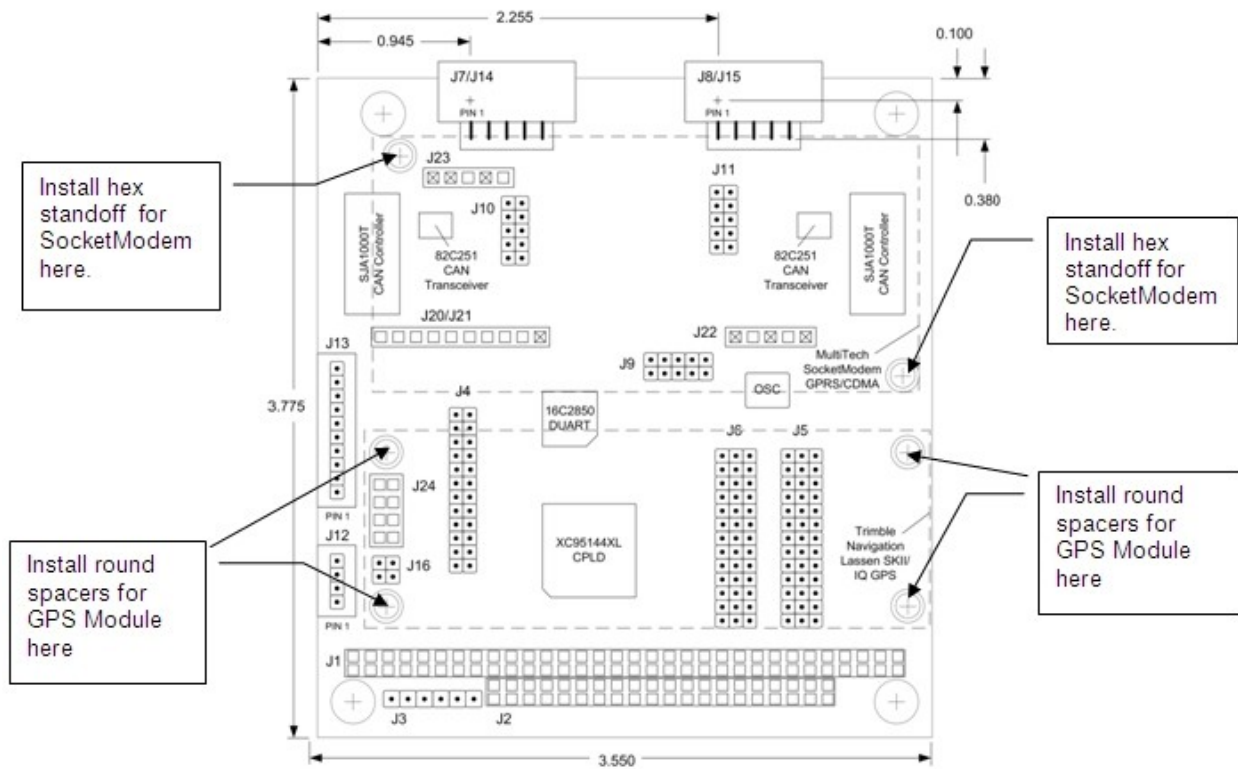

Figure 25: Janus-MM Board Layout

Trimble Lassen GPS Module Installation

Install the GPS Module before you install the Janus-MM card onto a PC/104 stack. You will need access to the bottom of the Janus-MM card to secure the spacers in place. These steps apply to both the GPS iQ and GPS SKII modules.

Set all jumpers as required for CAN bus operation and to control the dual UART accessing the SocketModem™ BEFORE you install any modules on the Janus-MM board. If jumper changes are required, you will need to remove the module to alter the jumper settings.

1. Insure that jumper J16 is set correctly for the module you are going to install. For the Lassen SKII™ module, set J16 for 5v operation. For the Lassen iQ™ module, set the jumper for 3.3v operation. Jumper settings for J16 are shown below.

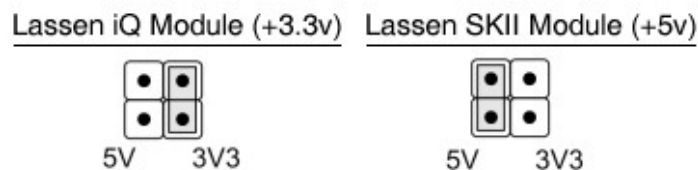

Figure 26: J16 Voltage Selection

2. In the Janus-MM GPS Hardware Kit, DSC #680015, find the following items.
 - a. 8 each 4-40 x 3/16" Pan Head screws (DSC #681043)
 - b. 4 each 0.25" OD x 0.12" ID Nylon Washer (DSC #683902)

- c. 4 each 4-40 x 0.375”L round .187” Diameter spacers (DSC #684244)
3. Place four pan head screws through the mounting holes in the GPS Module shown in Figure 28 and Figure 30, from the solder side to the component side.
4. On the component side, place a single nylon washer over each screw.
5. Screw one of the threaded round spacers onto each screw.
6. Place the GPS Module on the Janus MM PCB so that the connector on the GPS Module match up with and insert into connector J24 on the Janus MM module. Insure that the four mounting holes on the Janus MM PCB line up with the top of the four round spacers. Press firmly to seat the SocketModem on the Janus MM PCB.
7. Install the remaining four Pan Head Screws from the solder side of the Janus MM PCB through the PCB and into the round spacers. Tighten securely, but do not over-tighten.
8. Install the antenna transition cable, if necessary, directly to the GPS Module antenna connector. If you are using the Trimble Lassen SKII™ module, use transition cable DSC #6970003 (See Figure 27). If you are using the Trimble Lassen iQ™ module, use transition cable DSC#6970002 (See Figure 29).

With the iQ module, the antenna snaps into a connector on the metal iQ component that is facing the PCB. Turn the module over and insert the antennae transition cable connector into the slot cut in the PCB. See Figure 31 for the location of the slot and the location of the connector on the iQ component. Figure 32 shows the transition cable installed on the iQ module.

The antenna transition cable snaps into position.

9. Attach the antenna itself to the Antenna Transition Cable. For the Trimble Lassen SKII™ module, use the 5v antenna DSC #697001. For the Lassen iQ™ module, use the 3.3v antenna DSC #697004.

The GPS antenna transition cable connects to the antenna mounted on an enclosure. The enclosure cutout dimensions for the antenna mount are shown in Figure 33, for the Trimble Lassen iQ™ module, and Figure 34 for the Trimble Lassen SKII™ module.



Figure 27: Lassen SKII™ Transition Cable (DSC #6970003)



Figure 28: Lassen SKII™ Module



Figure 29: Lassen iQ™ Transition Cable (DSC #6970002)



Figure 30: Lassen iQ™ Module (Component Side)

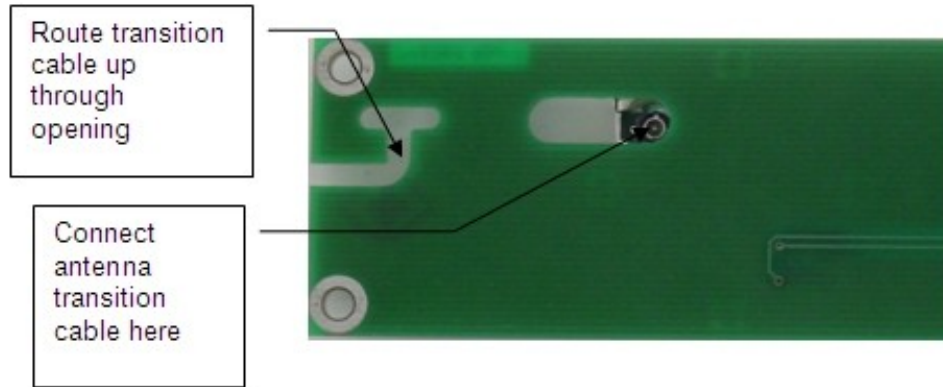

Figure 31: Lassen iQ™ Module Solder Side (enlarged view; see below)

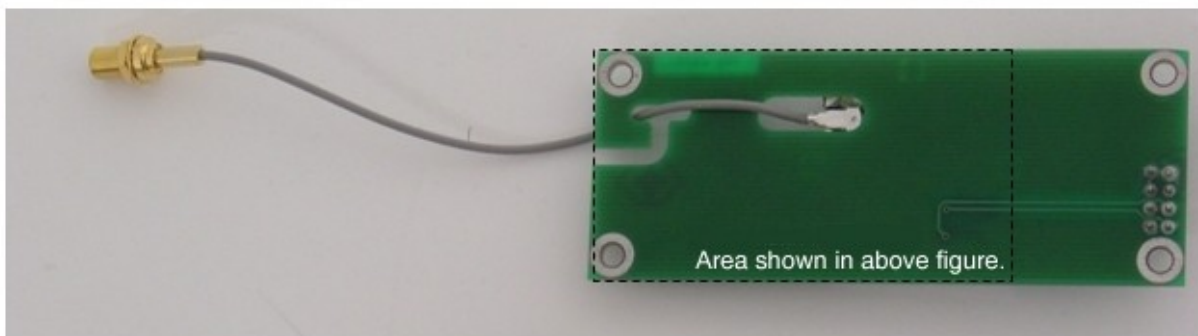

Figure 32: Lassen iQ™ Module with Antenna Transition Cable Installed

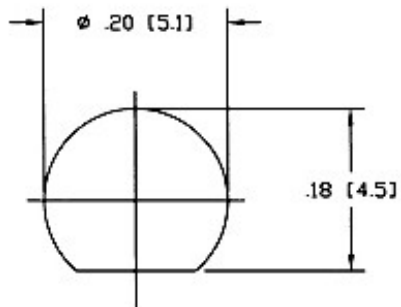

Figure 33: Panel (Bulkhead) Cutout for Lassen iQ™ Antenna Transition Cable

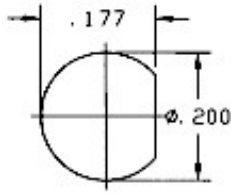

Figure 34: Panel (Bulkhead) Cutout for GPS SKII Antenna Transition Cable

PC/104 Extender Installation

Note: These installation apply to stacked systems, where the Janus-MM board is not the top board in the stack.

Follow these steps to install the PC/104 extender, which allows you to mount an additional PC/104 board on top of the stack without a component conflict with a GPS or SocketModem module.

1. In the PC/104 Extender Hardware Kit (DSC #6801017) , you will find the following:
 - a. 1 each 40-pin (2x20) PC/104 expansion header
 - b. 1 each 64-pin (2x32) PC/104 expansion header
 - c. 8 each 4-40 x 0.6" L M/F round standoffs
 - d. 5 each 0.25" OD x .12" ID x .062 T nylon washers
2. Install the Janus-MM board with modules installed on the PC/104 stack
3. Insert the 40-pin PC/104 expansion header into the 40-pin PC/104 connector (J2) on the Janus-MM board.
4. Insert the 64-pin PC/104 expansion header into the 64-pin PC/104 connector (J1) on the Janus-MM board.
5. Screw one 0.6" round standoff into each of the four PC/104 mounting holes. The round standoffs will go through the Janus-MM board and screw into the standoff below the Janus-MM board.
6. For each of the four remaining standoffs, place a single nylon washer on the female end of each standoff and screw the standoff directly into the top of each standoff protruding from the Janus-MM board. The washer matches the thickness of a PC/104 board.

Specifications

CAN Circuit

- CAN channels: 2 X 2.0B
- Controller: Philips SJA1000T
- Transceiver: Philips 82C251
- Isolation: 500VDC channel-to-channel, 500VDC channel-to-system
- Transceiver power: 5V, on-board or loop
- Clock rate: 16MHz
- Maximum data rate: 1.5Mbps
- Bus interface: memory or I/O

Wireless Modules

- Manufacturer: MultiTech Systems
- Types: GSM/GPRS or CDMA SocketModem™

GPS Modules

- Manufacturer: Trimble Navigation
- Models: Lassen SKII™ (8-channel) and Lassen iQ™ (12-channel)

General

- Dimensions: PC/1014 form factor: 3.550 x 3.775 x 0.062 (inches)/90.17 x 95.89 x 1.57 (mm)
- PC/104 bus: PC/104 specification, Rev 2.5
- Power supply: 77mA @ 5V – 385 mW (without modules)
- Operating temperature: -40° to +85° C
- Weight: 3.4 oz/96 g

Additional Information

The following documents provide additional interface and operational information for JANUS-MM peripheral modules and interfaces.

1. [Application Note AN96116,PCA82C250/251 CAN Transceiver](#), Philips Semiconductor, October 1996
2. [SocketModemTM GSM/GPRS Developer's Guide](#), Revision A, MultiTech Systems, May 2003
3. [AT Commands GSM Reference Guide](#), Revision A, MultiTech Systems, July 2003
4. [LassenTM SK II GPS System Designer Reference Manual](#), Trimble Navigation Limited, November 1999
5. [LassenTM iQ GPS Receiver System Designer Reference Manual](#), Revision A, Trimble Navigation Limited, February 2005

Additional information may also be found at the following websites.

1. Diamond Systems Corporation <http://www.diamondsystems.com/>
2. Philips Semiconductor <http://www.semiconductors.philips.com/>
3. MultiTech Systems <http://www.multitech.com/>
4. Trimble Navigation Limited <http://www.trimble.com/>

Technical Support

For technical support, please email support@diamondsystems.com or contact Diamond Systems Corporation technical support at 1-510-456-7800.

Appendix A

Available integrated JANUS-MM assemblies and development kits.

<i>JNMM-GPS-Y</i>	<i>Janus-MM CAN with GPS iQ module installed</i>
JNMM-COMBO-XT	Janus-MM CAN + Module Support Circuitry
MOD-GPS-Y	Lassen iQ or SKII GPS Module (Y = IQ or SK)
6801015	Hardware Kit, GPS Module

<i>JNMM-WSM-XX</i>	<i>Janus-MM CAN with Wireless SocketModem installed</i>
JNMM-COMBO-XT	Janus-MM CAN + Module Support Circuitry
MOD-WSM-XX	Wireless SocketModem Module (XX = F1, F2, N1, N2)
6801016	Hardware Kit, WSM Module

<i>JNMM-DUO-Y-XX</i>	<i>Janus-MM CAN with both GPS and SocketModem installed</i>
JNMM-COMBO-XT	Janus-MM CAN + Module Support Circuitry
MOD-GPS-Y	Lassen iQ or SKII GPS Module (Y = IQ or SK)
MOD-WSM-XX	Wireless SocketModem Module (XX = F1, F2, N1, N2)
6801015	Hardware Kit, GPS Module
6801016	Hardware Kit, WSM Module

<i>JNMM-GPS-Y-DK</i>	<i>Janus-MM GPS Dev Kit</i>
JNMM-COMBO-XT	Janus-MM CAN + Module Support Circuitry
MOD-GPS-Y	Lassen iQ or SKII GPS Module (Y = IQ or SK)
6801015	Hardware Kit, GPS Module
6801017	Hardware Kit, PC/104 Extender
6970001	Antenna, GPS Mag Mount 15ft
697000n	Cable, GPS Transition (n = 2 for IQ, 3 for SK)
CD containing documentation and software	

<i>JNMM-WSM-XX-DK</i>	<i>Janus-MM CAN with Wireless SocketModem Dev Kit</i>
JNMM-COMBO-XT	Janus-MM CAN + Module Support Circuitry
MOD-WSM-XX	Wireless SocketModem Module (XX = F1, F2, N1, N2)
6801016	Hardware Kit, WSM Module
6801017	Hardware Kit, PC/104 Extender
6970011	Antenna, Wireless SocketModem
6970012	Cable, Wireless SocketModem Transition
CD containing documentation and software	

<i>JNMM-DUO-Y-XX-DK</i>	<i>Janus-MM CAN w/ GPS and SocketModem installed Dev Kit</i>
JNMM-COMBO-XT	Janus-MM CAN + Module Support Circuitry
MOD-GPS-Y	Lassen iQ or SKII GPS Module (Y = IQ or SK)
MOD-WSM-XX	Wireless SocketModem Module (XX = F1, F2, N1, N2)
6801015	Hardware Kit, GPS Module
6970001	Antenna, GPS Mag Mount 15ft
697000n	Cable, GPS Transition (n = 2 for IQ, 3 for SK)
6801016	Hardware Kit, WSM Module
6970011	Antenna, Wireless SocketModem
6970012	Cable, Wireless SocketModem Transition
6801017	Hardware Kit, PC/104 Extender
CD containing documentation and software	

Appendix B

The following tables list the MultiTech wireless SocketModems™ compatible with the JANUS-MM board.

<i>Product</i>	<i>Description</i>
GPRS SocketModems™	
MOD-WSM-F1	900/1800 MHz GPRS Class 10
MOD-WSM-F2	850/1900 MHz GPRS Class 10
CDMA SocketModems™	
MOD-WSM-N1	800/1900 MHz CDMA2000 1xRTT
MOD-WSM-N2	800/1900 MHz CDMA2000 1xRTT

Other modules may be available. If you do not see a SocketModem™ module that supports your selected cellular provider, please contact your Diamond Systems sales representative for information about other available models.